

HAM TIPS



A PUBLICATION OF THE TUBE DEPARTMENT · RCA · HARRISON, N. J.

Volume X, No. 2

Spring, 1950

A Panoramic Adaptor with a Circular Base Line

By W. E. Babcock*

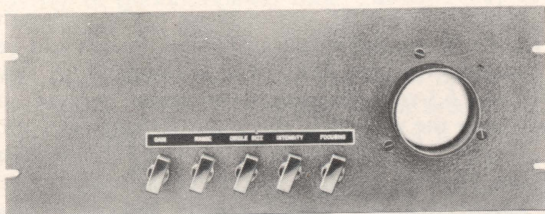

Figure 1. Panel view of the circular base line panadaptor showing position of the front controls and CR tube face.

SIMULTANEOUS visual reception of a large number of radio signals over a broad band of frequencies is provided by the panoramic adaptor. It may be used with almost any type of receiver and provides an indication of the frequency, type, and strength of all signals within a given bandwidth (centered at the frequency to which the receiver is tuned). When used to spot unoccupied channels in the band it can be an invaluable aid in avoiding interference problems. When used with a calibrated scale it becomes an accurate frequency meter. The amateur who owns a panoramic adaptor will no doubt find many additional uses for it.

Basically, a panoramic adaptor is a superheterodyne receiver with a broadly tuned r f stage and a narrow-band i f stage. However, in the conventional superheterodyne receiver, the local oscillator is fixed in frequency at any one time, while in the panoramic adaptor, the local oscillator is frequency modulated over a given band. In commercial panoramic adaptors, all signals within the bandwidth covered by the r f stage are shown on a cathode-ray tube as vertical "pips" on a horizontal base line. In the panoramic adaptor described here (and shown in Figure 1), a circular base line is used on which signals appear as radial pips extending toward the center of the screen. The frequency of any signal appearing

as a pip on the screen is determined by the position of the pip on the circumference of the circle as shown in Figure 2. The center frequency (to which the companion receiver is tuned) is shown at zero, while other signals are shown in proper frequency relationship to this zero.

General Circuit Description

A circuit diagram of the panoramic adaptor is given in Figure 5. The signal input to the adaptor is taken from the plate of the converter tube in the receiver. The 6AU6 r f stage is tuned to the intermediate frequency of the receiver and has a rising frequency characteristic either side of the center frequency to compensate for the drooping frequency characteristic resulting from the selectivity of the r f stage in the receiver. The plate circuit of the 6BE6 mixer stage is tuned to 160 kc, while the oscillator section is varied over a range of 50 kc above and below 616 kc (456 kc, the usual receiver i f, + 160 kc) at a rate of 60 times per second. The sawtooth voltage driving the reactance modulator tube, and the circular sweep voltage for the cathode-ray tube are both derived from the 60-cycle line voltage.

Plate and screen voltages for all tubes except the cathode-ray tube are obtained from a conventional full-wave rectifier. The screen voltage for the reactance modulator tube is held constant at 150 volts by the OA2 voltage regulator tube. The anode voltage for the cathode-ray tube is obtained from a voltage-doubler circuit in which the output voltage is added to that from the full-wave rectifier to give a total second-anode voltage of approximately 1100 volts. **This high voltage is dangerous.** Extreme care must be exercised if it is necessary to work on the adaptor with the power on. Be sure the high voltage filter capacitors are discharged when making tests with the power off.

*Application Engineering, RCA Tube Dept., Harrison, N. J.

Use of Standard Components

All components used in the construction of the panoramic adaptor are standard receiver replacement components. Many hams will no doubt have many of the parts on hand. The transformers used in the if stages are designed to tune to 175 kc. However, their tuning range is such that they may easily be tuned to 160 kc. Maximum width of the pips obtained when these transformers are used is approximately 5 kc at the base line. This bandwidth is sharp enough for observing signals differing by less than 5 kc.

Construction and Layout Details

The adaptor is constructed on a 10"x14"x3" chassis with a standard 7"x19"x1/8" rack mounting panel. Figures 3 and 4 illustrate the chassis layout. No special precautions are required in constructing the adaptor other than those normally practiced in constructing receiver if stages. The cathode-ray tube, of course, should be mounted as far from the power transformer as possible to minimize hum pickup on the deflection plates. If difficulty is experienced with hum pickup on the grid of the cathode-ray tube, it may be necessary to add a 4- μ f capacitor (C_{32}) from the cathode of the 3KP1 to the arm of the intensity control.

Auxiliary Use

For the station that does not have a modulation monitor, the cathode-ray tube in the panoramic adaptor can be used for this purpose. For this use, capacitors C_{28} , C_{29} , C_{30} , and C_{31} should be connected by means of a 4-pole double-throw relay so they will connect the deflection plates of the cathode-ray tube to the plates of the deflection amplifier tubes in the adaptor on "receive" and to the rf and modulating voltages of the transmitter on "transmit." The coupling to the transmitter should be such that the voltage ratings of C_{28} , C_{29} , C_{30} , and C_{31} are not exceeded. For more detailed information on the use of a cathode-ray tube as a modulation indicator, see Ham Tips of January-April, 1948.

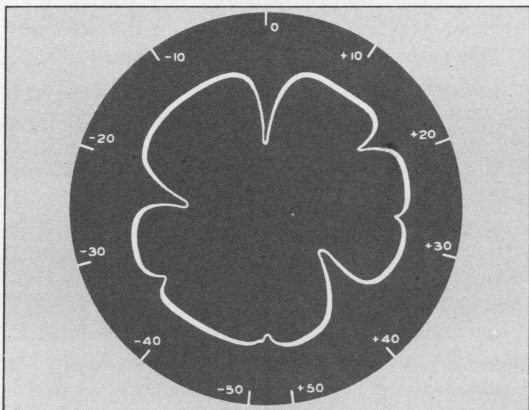

Figure 2. The position of the pips on the circumference of the circle indicates the frequency of the received signals.

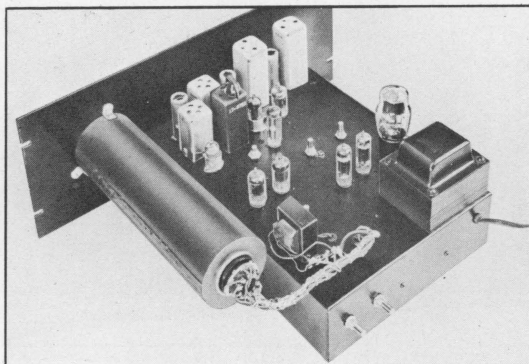

Figure 3. A bird's eye view of the panadaptor illustrates the chassis layout. The cylindrical sleeve supports the c-r tube.

Alignment Procedure

Variable resistor R_{35} and capacitor C_{26} form a phase-shifting network which applies two sinusoidal voltages 90° out of phase to the push-pull grids of the deflection amplifiers. R_{35} should be varied until the best circle is obtained. A separate 6.3-volt filament transformer is used to supply the voltage to the phase-shifting network. It would be possible to supply this voltage from the filament winding of the power transformer, except that any heater-cathode leakage in the tubes would result in spikes being superimposed on the heater voltage and consequent distortion of the circle. If the line voltage has a perfect sinusoidal wave form, the circle on the screen of the cathode-ray tube will be very nearly perfect. Although in most cases, the line voltage will vary slightly from a perfect sine wave, the resulting pattern will still be very nearly a circle.

During alignment of the if stage, a high-impedance dc voltmeter, such as an RCA Volt-ohmyst*, is connected across the detector load resistance (R_{14}). With R_{22} set at zero, a 160-kc signal from a signal generator is applied to the signal grid (grid No. 3) of the 6BE6 and the if transformers are peaked for maximum dc voltage across the detector load resistance.

Variable capacitor C_{14} controls both the magnitude and phase of the rf voltage appearing at the control grid of the reactance tube. Its setting is not critical, but during the adjustments described in the following paragraph, it should be set near maximum capacitance. If it is desired to increase the frequency range of the adaptor, at a sacrifice of linearity, approximately 50 kc more deviation may be obtained by setting C_{14} to maximum capacitance.

Sweep padder, R_{21} is used to set the amplitude of the sawtooth voltage obtained from the plate of the sawtooth generator so that the total frequency deviation of the local oscillator is exactly 100 kc when R_{22} is at maximum. It should initially be set at about half scale. The center fre-

*Reg. Trade Mark, U. S. Pat. Off.

frequency f_0 should be set to the proper value (616 kc if the companion receiver has an i_f of 456 kc). Capacitors C_A and C_B which are contained in oscillator transformer T_3 are used to set f_0 . C_A is a coarse tuning adjustment which may be turned with a screw driver; C_B is a fine tuning adjustment controlled by a knob at the top of T_3 . However, R_{20} in the cathode circuit of the reactance tube will also have a slight effect on f_0 . R_{20} is used to set the cathode bias of the reactance tube so that the frequency deviation of the oscillator is linear. It should be set initially to give a cathode-to-ground voltage of approximately 2 volts. With control R_{22} set at minimum and with a 456-kc signal applied to the signal grid of the mixer stage, C_B is then adjusted to give maximum dc voltage across R_{14} . Control R_{22} is then set at maximum. A pip, corresponding to the 456-kc input signal, will now appear on the screen of the cathode-ray tube. The tube may be rotated so that this pip appears at the top of the screen. The signal generator frequency should now be shifted 50 kc above and below the center frequency of 456 kc. The pip will be seen to rotate around the circle as the frequency is shifted. When the deviation of the local oscillator is set to exactly ± 50 kc, the pip will travel almost the full 360° of the circle as the signal-generator frequency is shifted from 406 to 506 kc. If the pip moves around the circle before the range is covered, the sawtooth voltage applied to the grid of the reactance tube is not great enough and the resistance of sweep padder R_{21} should be decreased until the proper frequency range is covered. If too great a range is covered, the resistance of R_{21} should be increased.

Linearity and Bandwidth

Approximately 10° at the bottom of the circle is taken up by the retrace of the sawtooth voltage driving the reactance tube. During this interval, the local oscillator is being frequency-modulated 50 kc each side of f_0 in the same manner as during the rising portion of the sawtooth, except that the deviation is in the opposite direction and occurs in a much shorter time. This deviation causes a small pip to appear at the bottom of the circle whenever a signal is applied to the adaptor. Since this pip occupies such a small portion of the circle (approximately 10°), it will appear to remain stationary as the input signal frequency is varied. It may be used as a dividing marker between 406 and 506 kc.

After the frequency deviation of the local oscillator is set to the proper value, the linearity of the deviation should be checked. If the deviation is linear, half the circle will be traced for a 50-kc frequency change of the signal generator. If either more or less than half the circle is traced,

R_{20} should be adjusted slightly. Since any adjustment of R_{20} causes a slight shift in f_0 , the setting of C_B must be changed to correct it. If the linearity is poorer, the adjustment of R_{20} has been in the wrong direction. After R_{20} is set for best linearity, it may be found that the frequency range covered has changed and R_{21} will have to be adjusted also.

Capacitors C_1 and C_5 are used to overcouple the r f transformers and thus give a rising frequency characteristic each side of the center frequency (456 kc for most receivers). The primaries of T_1 and T_2 are tuned approximately 10 kc below the maximum frequency to be received (496 kc). The secondaries of T_1 and T_2 are tuned approximately 10 kc above the lowest frequency to be received (416 kc). Approximate alignment is obtained by applying a 496-kc signal from a signal generator to the input of the adaptor and adjusting the primaries of T_1 and T_2 for maximum deflection on the screen of the cathode-ray tube. The signal-generator frequency is then changed to 416 kc and the secondaries of T_1 and T_2 adjusted for maximum deflection.

Final Alignment

The final alignment should be done with the adaptor connected to the plate of the converter tube in the receiver with which it will be used by means of a 47,000-ohm isolating resistor (R_A). This resistor should be connected as close to the converter plate as possible and a shielded lead used between the resistor and the adaptor input. With the receiver tuned to approximately 3 Mc, set the signal generator to the same frequency and tune the receiver until the signal appears as a deflection at the top of the screen. Then change the signal generator frequency 50 kc higher, moving the deflection clock-wise to the bottom of the screen. Adjust the trimmers on T_1 and T_2 until

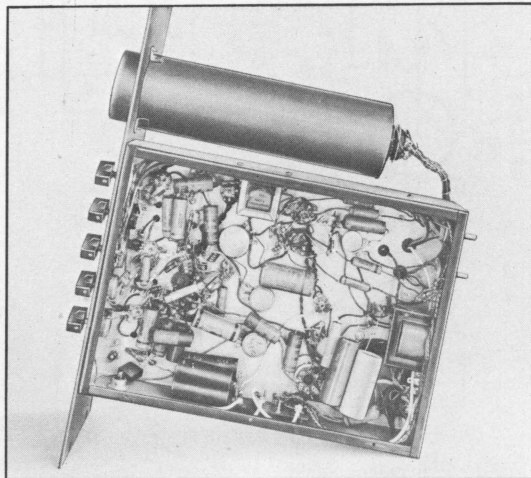

Figure 4. Placement of components and wiring on the under-chassis of the panadaptor reveals compactness without crowding.

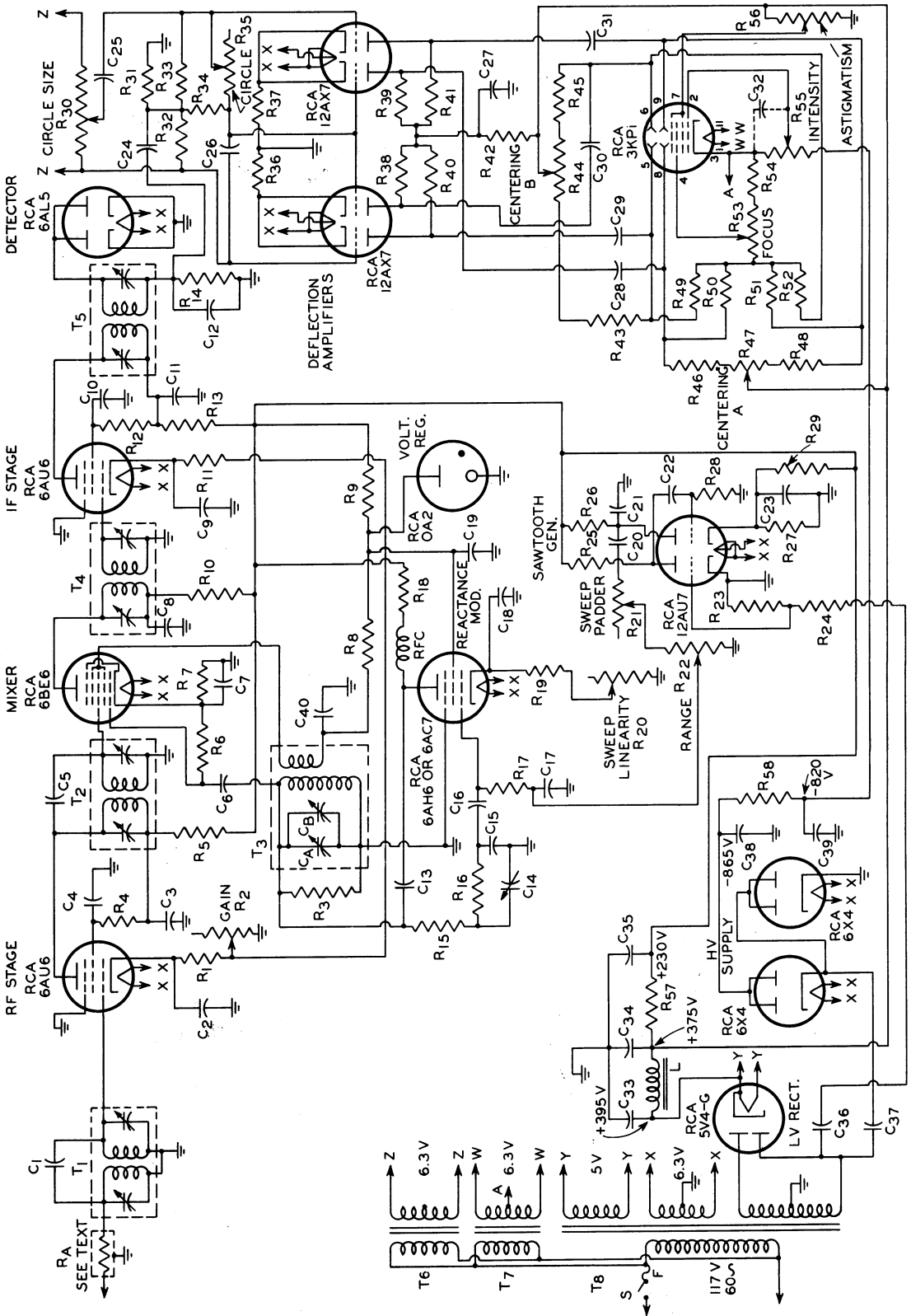

Figure 5. Schematic of the panadaptor.

the amplitude of the deflection is approximately the same as it was at the center. Then change the signal generator frequency 50 kc lower, moving the deflection counterclockwise to the bottom of the screen. Again adjust the trimmers to make the amplitude of the deflection approximately what it was at the center. This second adjustment will upset the first adjustment, and it will be necessary to go back and forth and to compromise on adjustments in order to make the gain as nearly uniform as possible over the entire 100-kc range.

Alignment for Other Frequencies

The r f stage of the adaptor may be aligned for center frequencies from about 420-500 kc. If the companion receiver has an intermediate frequency different from 456 kc, but falling within the 420-500 kc range, the alignment procedure is exactly as given above, except that it is necessary to correct the alignment frequencies of the r f stage and the local oscillator.

Calibration of Scale

If accurate frequency readings are desired a calibrated scale may be made up on lucite or other transparent material and placed in front of the cathode-ray tube screen. The scale may be calibrated using a signal generator to determine the desired calibration points. When the signals are obtained directly from a signal generator, it should be remembered that signals from 456 kc to 506 kc will appear on the left half of the

RCA HAM TIPS is published by the RCA Tube Department, Harrison, N. J., and is made available to Amateurs and Radio Experimenters through RCA tube and parts distributors.

MEET THE GANG

GEORGE E. JONES, JR.

W2CBL since 1930
ex-W9BDJ since 1922
Age: 41
Employed in: Equipment Section, RCA Tube Department, Harrison, N. J.
Home QTH: 71 Lincoln Drive, Rochelle Park, N. J.
Graduate of: Kansas University '30.
Active on: 20 and 80 phone & cw.
Rig: 350 watts to pair RCA 812-A's.
XYL: Jean.
Harmonics: George—age 10, Phyllis—age 6.
Articles: DeLux 812-A Bandswitching Transmitter—Ham Tips.
Other Hobbies: Model railroads and table tennis.

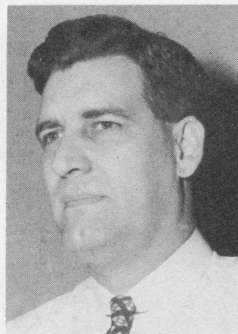

circle, while signals from 456 kc to 406 kc will appear on the right half. When the signals are obtained from the output of the converter tube in the receiver, signals up to 50 kc above the receiver frequency will appear on the right half of the circle and signals up to 50 kc below the receiver frequency will appear on the left half.

PARTS LIST

C1, C5 47-uuf ceramic
C2, C3, C7, C8, C10, C11, C28, C29, C30, C31, C40 0.01-uf 400 V paper
C4, C9, C18, C25 0.1-uf 400 V paper
C6 68-uuf ceramic
C12, C13 470-uuf mica
C14 1—10-uuf ceramic trimmer
C15 15-uuf mica
C16 100-uuf 600 V paper
C17 270-uuf mica
C19 0.006-uf 400 V paper
C20 0.25-uf 400 V paper
C21, C22, C27, C36, C37 0.1-uf 600 V paper
C23 25-uf 25 WV electrolytic
C24 0.03-uf 400 V paper
C26 1-uf 600 V paper
C32 4-uf 150 WV electrolytic
C33, C34 16-uf 450 WV electrolytic
C35 40-uf 450 WV electrolytic
C38, C39 0.1-uf 2000 V paper
RA 47,000 ohms, in receiver connected to plate of converter tube
R1 100 ohms
R2 10,000 ohm potentiometer—linear taper
R3 51,000 ohms
R4, R12 22,000 ohms
R5, R10 4700 ohms 1 watt
R6 24,000 ohms
R7 150 ohms
R8 6800 ohms
R9 2200 ohms 5 watt
R11, R19 100 ohms
R13 3300 ohms 1 watt
R14 680,000 ohms
R15 20,000 ohms
R16 100,000 ohms
R17, R31, R32, R33, R34, R58 220,000 ohms

R18 3000 ohms 1 watt
R20 500,000 ohm potentiometer—linear taper
R21, R44, R47, R56 1 megohm potentiometer—linear taper
R22 100,000 ohm potentiometer—linear taper
R23, R24, R25, R26, R28, R54 1 megohm
R27 4700 ohms
R29 51,000 ohms 2 watt
R30 20 ohm potentiometer, 5 watt
R35 5000 ohm potentiometer—linear
R36 270 ohms
R37 390 ohms
R38, R39, R40, R41 27,000 ohms
R42 3300 ohms
R43, R45, R46, R48 3.9 megohms
R49, R50, R51, R52 20 megohms
R53 2 megohm potentiometer—linear taper
R55 0.5 megohm potentiometer—logarithmic taper
R57 2500 ohms, 10-watt
T1 456-kc i f transformer; Meissner 16-5740 or equiv.
T2 456-kc i f transformer; Meissner 16-5742 or equiv.
T3 Oscillator transformer; Meissner 17-6753 or equiv.
T4 175-kc i f transformer; Meissner 16-6649 or equiv.
T5 175-kc i f transformer; Meissner 16-6651 or equiv.
T6, T7 Filament transformer 6.3 volts, 1 amp; Thordarson T21F08 or equivalent
T8 Power transformer 350-0-350 volts 120 ma;—6.3 volts, 4.7 amp; 5 volts, 3 amp; Thordarson TS-24R05 or equivalent
S SPST switch (mounted on R55)
F Fuse
RFC RF choke 30 mh
L Filter choke—8 henrys—150 ma Thordarson T-20C54 or equivalent
All resistors 0.5 watt unless otherwise specified.

Introducing...

HAM TIPS



A PUBLICATION OF THE TUBE DEPARTMENT · RCA · HARRISON, N. J.

A Panoramic Adaptor with a Circular Base Line

By W. E. Babcock*

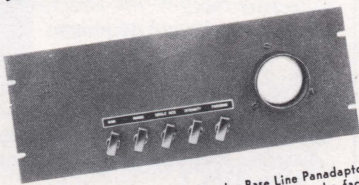

Figure 1. Panel view of the Circular Base Line Panadaptor showing position of the front controls and CR tube face.

SIMULTANEOUS visual reception of a large number of radio signals over a broad band of frequencies is provided by almost any type of receiver. It may be used with almost any type of receiver and provides an indication of the frequency, type, and strength of all signals within a given bandwidth (centered at the frequency to which the receiver is tuned). When used to spot unoccupied channels in the band it can be an invaluable aid in avoiding interference problems. When used with a calibrated scale it becomes an accuracy frequency meter. The amateur who owns a panoramic adaptor will no doubt find many additional uses for it.

Basically, a panoramic adaptor is a super-

bandwidth r f stage with a broadly tuned r f stage as a pip on the screen is determined by the position of the pip on the circumference of the circle as shown in Figure 2. The center frequency (to which the receiver is tuned) is shown at zero, while other signals are shown in proper frequency relationship to this zero.

General Circuit Description

A circuit diagram of the panoramic adaptor is given in Figure 3. The signal input to the adaptor is taken from the plate of the converter tube in the receiver. The 6AU6 r f stage is tuned to the intermediate frequency of the receiver and has a rising frequency characteristic either side of the center frequency to compensate for the droop frequency characteristic resulting from the selectivity of the r f sp-stage in the receiver. The p circuit of the 6BE6 mixer section is tuned to the usual receiver i f, + 160 kc) at the rate of 6 times per second. The sawtooth voltage driving the reactance modulator tube, and the circular sweep voltage for the cathode-ray tube are both derived from the 60-cycle line voltage.

Plate and screen voltages for all tubes except the cathode-ray tube are obtained from a conventional full-wave rectifier. The anode voltage of the cathode-ray tube is obtained from a full-wave rectifier in which the output volt-

The new **RCA** HAM TIPS... New Size...New Layout...New Color

What is it? A publication of the RCA Tube Department . . . Ham Tips is written expressly for amateurs by active amateurs who are members of RCA's engineering staff.

What's in it? The latest dope on tube applications, new circuits, and new equipment designs, that you can put to practical everyday use.

How obtained? There is no charge for Ham Tips. You can get your copy from the nearest RCA tube distributor handling amateur tube types.

When issued? RCA Ham Tips is published every other month. Make it a point to visit your tube distributor regularly so you won't miss a copy.



RADIO CORPORATION of AMERICA
ELECTRON TUBES
HARRISON, N. J.