

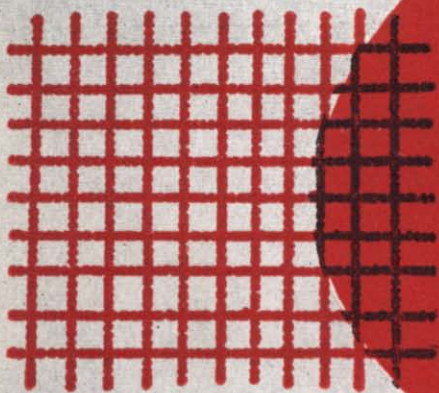

**RCA**

*receiving  
tube  
manual*



**TUBE DIVISION**  
**RADIO CORPORATION of AMERICA**  
**HARRISON, N. J.**

# CONTENTS

|  | PAGE |
|--|------|
| <b>ELECTRONS, ELECTRODES, AND ELECTRON TUBES</b> . . . . .   | 3    |
| Electrons, Cathodes, Generic Tube Types, Diodes, Triodes, Pentodes, Beam Power Tubes, Multi-Electrode and Multi-Unit Types, Kinescopes   |      |
| <b>ELECTRON TUBE CHARACTERISTICS</b> . . . . .   | 12   |
| <b>ELECTRON TUBE APPLICATIONS</b> . . . . .  | 14   |
| Amplification, Rectification, Detection, Automatic Volume Control, Tuning Indication with Electron-Ray Tubes, Oscillation, Frequency Conversion, Automatic Frequency Control   |      |
| <b>ELECTRON TUBE INSTALLATION</b> . . . . .  | 49   |
| Filament and Heater Supply, Heater-to-Cathode Connection, Plate Voltage Supply, Grid Voltage Supply, Screen Voltage Supply, Shielding, Dress of Circuit Leads, Filters, Output-Coupling Devices, High-Voltage Considerations for Kinescopes, Kinescope Safety Considerations |      |
| <b>INTERPRETATION OF TUBE DATA</b> . . . . .   | 60   |
| <b>RECEIVING TUBE CLASSIFICATION CHART</b> . . . . .   | 66   |
| <b>TUBE TYPES—Technical Data</b> . . . . .   | 69   |
| <b>KINESCOPE CHARACTERISTICS CHART</b> . . . . .   | 246  |
| <b>ELECTRON TUBE TESTING</b> . . . . .   | 251  |
| <b>RESISTANCE-COUPLED AMPLIFIERS</b> . . . . .   | 255  |
| <b>CIRCUITS</b> . . . . .  | 269  |
| <b>OUTLINES</b> . . . . .  | 289  |
| <b>INDEX</b> . . . . .   | 295  |
| <b>READING LIST</b> . . . . .  | 320  |

## Key to Socket Connection Diagrams

### *Bottom Views*

|                                 |  |                            |
|---------------------------------|--|----------------------------|
| ● = Gas-Type Tube               | FM = Filament Mid-Tap                      | IS = Internal Shield       |
| BC = Base Sleeve                | G = Grid                                   | K = Cathode                |
| BS = Base Shell                 | H = Heater                                 | NC = No Connection         |
| C = External Conductive Coating | H <sub>L</sub> = Heater Tap for Panel Lamp | P = Plate (Anode)          |
| CL = Collector                  | H <sub>M</sub> = Heater Mid-Tap            | RC = Ray-Control Electrode |
| DJ = Deflecting Electrode       | IC = Internal Connection—                  | S = Shell                  |
| ES = External Shield            | Do Not Use                                 | TA = Target                |
| F = Filament                    |  | U = Unit                   |

*Alphabetical Subscripts B,D,HP,HX,P, and T indicate, respectively, beam unit, diode unit, heptode unit, hexode unit, pentode unit, and triode unit in multi-unit types.*



Marca Registrada

Devices and arrangements shown or described herein may use patents of RCA or others. Information contained herein is furnished without responsibility by RCA for its use and without prejudice to RCA's patent rights.

# RCA Receiving Tube MANUAL

THIS MANUAL like its preceding editions has been prepared to assist those who work or experiment with electron tubes and circuits. It will be found valuable by engineers, service technicians, experimenters, students, radio amateurs, and all others technically interested in electron tubes.

The material in this edition has been augmented and revised to keep abreast of the technological advances in electronic fields. Many tube types widely used in the design of new electronic equipment prior to 1950 are now chiefly of renewal interest; in their place, new advanced types are being used. Consequently, in the Tube Types Section, the presentation on the older types has been limited to essential basic data while detailed information has been given on the newer more important types.

---

In addition to the tube types for home-entertainment use covered in this Manual, the TUBE DIVISION of RADIO CORPORATION OF AMERICA offers other small receiving-type tubes for industrial and specialized applications, such as the "Special Red" tubes, premium tubes, computer tubes, voltage regulators, acorn tubes, and pencil tubes. Other lines of RCA electron tubes include:

## **POWER TUBES**

*Transmitting and  
Industrial Types*

## **TELEVISION CAMERA TUBES**

*Iconoscopes, Vidicons,  
and Image Orthicons*

## **PHOTOTUBES**

*Single-Unit, Twin-Unit,  
and Multiplier Types*

## **CATHODE-RAY TUBES**

*Special-Purpose  
Kinescopes and  
Oscillograph Types*

## **THYRATRONS & IGNITRONS**

## **SPECIAL TYPES**

*Vacuum-Gauge Tubes,  
Magnetrons and Klystrons*

---

For Sales Information  
on RCA Tubes, write to  
*Sales*

For Technical Information  
on RCA Tubes, write to  
*Commercial Engineering*

TUBE DIVISION  
RADIO CORPORATION OF AMERICA  
Harrison, N. J.

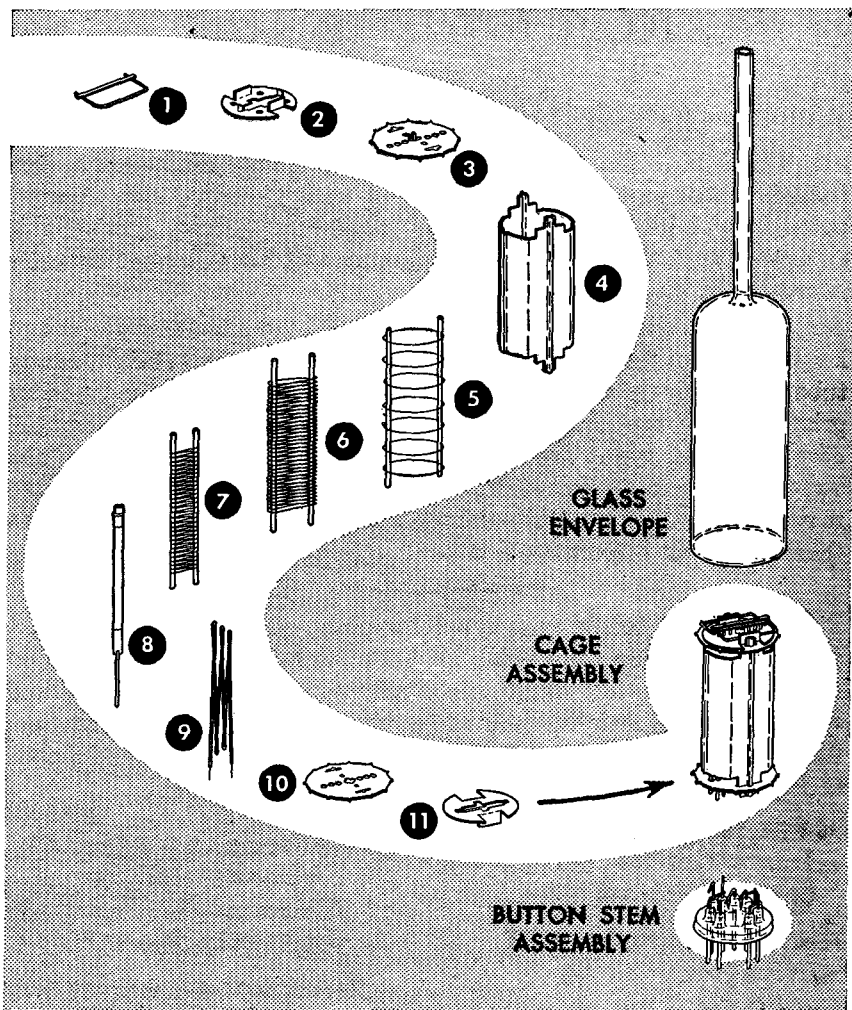

### CAGE PARTS

- |                       |                                 |                          |
|-----------------------|---------------------------------|--------------------------|
| 1. Getter and Support | 5. Grid No. 3<br>(Suppressor)   | 8. Cathode               |
| 2. Top Spacer Shield  | 6. Grid No. 2 (Screen)          | 9. Heater                |
| 3. Insulating Spacer  | 7. Grid No. 1<br>(Control Grid) | 10. Insulating Spacer    |
| 4. Plate              |                                 | 11. Bottom Spacer Shield |

## The Parts of a Miniature Pentode

# *RCA Receiving Tube* MANUAL

## Electrons, Electrodes, and Electron Tubes

The electron tube is a marvelous device. It makes possible the performing of operations, amazing in conception, with a precision and a certainty that are astounding. It is an exceedingly sensitive and accurate instrument—the product of coordinated efforts of engineers and craftsmen. Its construction requires materials from every corner of the earth. Its use is world-wide. Its future possibilities, even in the light of present-day accomplishments, are but dimly foreseen; for each development opens new fields of design and application.

The importance of the electron tube lies in its ability to control almost instantly the flight of the millions of electrons supplied by the cathode. It accomplishes this with a minimum of control energy. Because it is almost instantaneous in its action, the electron tube can operate efficiently and accurately at electrical frequencies much higher than those attainable with rotating machines.

### ELECTRONS

All matter exists in the solid, liquid, or gaseous state. These three forms consist entirely of minute divisions known as molecules, which, in turn, are composed of atoms. Atoms have a nucleus which is a positive charge of electricity, around which revolve tiny charges of negative electricity known as **electrons**. Scientists have estimated that electrons weigh only 1/30-billion, billion, billion, billionths of an ounce, and that they may travel at speeds of thousands of miles per second.

Electron movement may be accelerated by the addition of energy. Heat is one form of energy which can be conveniently used to speed up the electron. For example, if the temperature of a metal is gradually raised, the electrons in the metal gain velocity. When the metal becomes hot enough, some electrons may acquire sufficient speed to break away from the surface of the metal. This action, which is accelerated when the metal is heated in a vacuum, is utilized in most electron tubes to produce the necessary electron supply.

An electron tube consists of a cathode, which supplies electrons, and one or more additional electrodes, which control and collect these electrons, mounted in an evacuated envelope. The envelope may be a glass bulb or a metal shell.

### CATHODES

A cathode is an essential part of an electron tube because it supplies the electrons necessary for tube operation. When energy in some form is applied to the cathode, electrons are released. Heat is the form of energy generally used. The method of heating the cathode may be used to distinguish between the different forms of cathodes. For example, a directly heated cathode, or filament-cathode, is a wire heated by the passage of an electric current. An indirectly heated cathode, or heater-cathode, consists of a filament, or heater, enclosed in a metal sleeve. The sleeve carries the electron-emitting material on its outside surface and is heated by radiation and conduction from the heater.

A filament, or directly heated cathode, may be further classified by identifying the filament or electron-emitting material. The materials in regular use are tungsten, thoriated tungsten, and metals which have been coated with alkaline-earth oxides. Tungsten filaments are made from the pure metal. Because they must operate at high temperatures (a dazzling white) to emit sufficient electrons, a relatively large amount of filament power is required. Thoriated-tungsten filaments are made from tungsten impregnated with thorium oxide. Due to the presence of thorium, these filaments liberate electrons at a more moderate temperature of about 1700°C (a bright yellow) and are, therefore, much more economical of filament power than are pure tungsten filaments. Alkaline earths are usually applied as a coating on a nickel-alloy wire or ribbon. This coating, which is dried in a relatively thick layer on the filament, requires only a relatively low temperature of about 700-750°C (a dull red) to produce a copious supply of electrons. Coated filaments operate very efficiently and require relatively little filament power. However, each of these cathode materials has special advantages which determine the choice for a particular application.

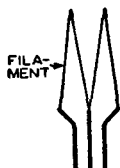

Fig. 1

Directly heated filament-cathodes require comparatively little heating power. They are used in almost all of the tube types designed for battery operation because it is, of course, desirable to impose as small a drain as possible on the batteries. Examples of battery-operated filament types are the 1A7-GT, 1R5, 1U4, and 3V4. AC-operated types having directly heated filament-cathodes include the 2A3 and 5Y3-GT.

An indirectly heated cathode, or heater-cathode, consists of a thin metal sleeve coated with electron-emitting material such as alkaline-earth oxides. Within the sleeve is a heater which is insulated from the sleeve. The heater is made of tungsten or tungsten-alloy wire and is used only for the purpose of heating the cathode sleeve and sleeve coating to an electron-emitting temperature. Useful emission does not take place from the heater wire.

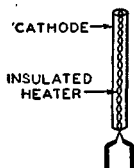

Fig. 2

The heater-cathode construction is well adapted for use in electron tubes intended for operation from ac power lines and from storage batteries. The use of separate parts for emitter and heater functions, the electrical insulation of the heater from the emitter, and the shielding effect of the sleeve may all be utilized in the design of the tube to minimize the introduction of hum from the ac heater supply and to minimize electrical interference which might enter the tube circuit through the heater-supply line. From the viewpoint of circuit design, the heater-cathode construction offers advantages in connection flexibility because of the electrical separation of the heater from the cathode. Another advantage of the heater-cathode construction is that it makes practical the design of a rectifier tube having close spacing between its cathode and plate, and of an amplifier tube having close spacing between its cathode and grid. In a close-spaced rectifier tube, the voltage drop in the tube is low, and, therefore, the regulation is improved. In an amplifier tube, the close spacing increases the gain obtainable from the tube. Because of the advantages of the heater-cathode construction, almost all present-day receiving tubes designed for ac operation have heater-cathodes.

## GENERIC TUBE TYPES

Electrons are of no value in an electron tube unless they can be put to work. Therefore, a tube is designed with the parts necessary to utilize electrons as well as those required to produce them. These parts consist of a cathode and one or more supplementary electrodes. The electrodes are enclosed in an evacuated envelope having the necessary connections brought out through air-tight seals. The air is removed from the envelope to allow free movement of the electrons and to prevent injury to the emitting surface of the cathode. When the cathode is heated, electrons

leave the cathode surface and form an invisible cloud in the space around it. Any positive electric potential within the evacuated envelope offers a strong attraction to the electrons (unlike electric charges attract; like charges repel). Such a positive electric potential can be supplied by an anode (positive electrode) located within the tube in proximity to the cathode.

## DIODES

The simplest form of electron tube contains two electrodes, a cathode and an anode (plate), and is often called a diode, the family name for a two-electrode tube. In a diode, the positive potential is supplied by a suitable electrical source connected between the plate terminal and a cathode terminal. Under the influence of the positive plate potential, electrons flow from the cathode to the plate and return through the external plate-battery circuit to the cathode, thus completing the circuit. This flow of electrons is known as the plate current.

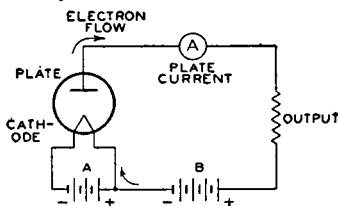

Fig. 3

If a negative potential is applied to the plate, the free electrons in the space surrounding the cathode will be forced back to the cathode and no plate current will flow. Thus, electrons can flow from the cathode to the plate but not from the plate to the cathode. If an alternating voltage is applied to the plate, the plate is alternately made positive and negative. Because plate current flows only during the time when the plate is positive, current flows through the tube in only one direction and is said to be rectified. Fig. 4 shows the rectified output current produced by an alternating input voltage. Diode rectifiers are used in ac receivers to convert the ac supply voltage to dc voltage for the electrodes of the other tubes in the receiver. Rectifier tubes having only one plate and one cathode, such as the 35W4, are called **half-wave rectifiers**, because current can flow only during one-half of the alternating-current cycle. When two plates and one or more cathodes are used in the same tube, current may be obtained on both halves of the ac cycle. The 6X4, 5Y3-GT, and 5U4-G are examples of this type and are called **full-wave rectifiers**.

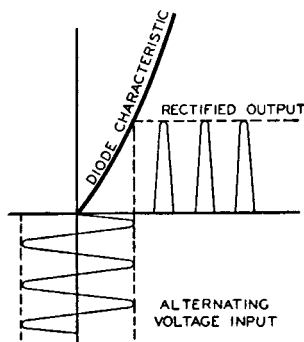

Fig. 4

Not all of the electrons emitted by the cathode reach the plate. Some return to the cathode while others remain in the space between the cathode and plate for a brief period to produce an effect known as **space-charge**. This charge has a repelling action on other electrons which leave the cathode surface and impedes their passage to the plate. The extent of this action and the amount of space-charge depend on the cathode temperature and the plate potential. The higher the plate potential, the less is the tendency for electrons to remain in the space-charge region and repel other electrons. This effect may be noted by applying increasingly higher plate voltages to a tube operating at a fixed heater or filament voltage. Under these conditions, the maximum number of available electrons is fixed, but increasingly higher plate voltages will succeed in attracting a greater proportion of the free electrons.

Beyond a certain plate voltage, however, additional plate voltage has little effect in increasing the plate current because all of the electrons emitted by the cathode are already being drawn to the plate. This maximum current, illustrated in Fig. 5, is called **saturation current**. Because it is an indication of the total number of electrons emitted, it is also known as **emission current** or simply **emission**.

Although tubes are sometimes tested by measurement of their emission current, it is generally not advisable to measure the full value of emission because this value would be sufficiently large to cause change in the tube's characteristics or even to damage the tube. Consequently, while the test value of emission current is somewhat larger than the maximum current which will be required from the cathode in the use of the tube, it is ordinarily less than the full emission current. The emission test, therefore, is used to indicate whether the cathode can supply a sufficient number of electrons for satisfactory operation of the tube.

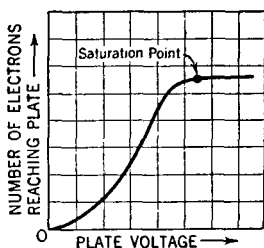

Fig. 5

If space charge were not present to repel electrons coming from the cathode, the same plate current could be produced at a lower plate voltage. One way to make the effect of space charge small is to make the distance between plate and cathode small. This method is used in rectifier types having heater-cathodes, such as the 5V4-G and the 25Z6. In these types the radial distance between cathode and plate is only about two hundredths of an inch. Another method of reducing space-charge effect is utilized in **mercury-vapor rectifier tubes**, such as the 83. Such tubes contain a small amount of mercury, which is partially vaporized when the tube is operated, filling the space inside the bulb with mercury atoms. These atoms are bombarded by electrons on their way to the plate. If the electrons are moving at a sufficiently high speed, the collisions tear off electrons from the mercury atoms. The mercury atom is then said to be "ionized"; that is, it has lost one or more electrons and, therefore, has a positive charge. In mercury-vapor rectifier tubes, ionization is evidenced by a bluish-green glow between the cathode and plate. When ionization due to bombardment of mercury atoms by electrons leaving the cathode occurs, the space-charge is neutralized by the positive mercury ions so that increased numbers of electrons are made available. A mercury-vapor rectifier has a small voltage drop between cathode and plate (about 15 volts). This drop is practically independent of current requirements up to the limit of emission of electrons from the cathode, but is dependent to some degree on bulb temperature.

**Ionic-heated-cathode rectifier tubes**, such as the 0Z4 and 0Z4-G, also depend on gas ionization for their operation. These tubes are of the full-wave design and contain two anodes and a coated cathode sealed in a bulb containing a reduced pressure of inert gas. The cathode in each of these types becomes hot during tube operation, but the heating effect is caused by bombardment of the cathode by ions within the tube rather than by heater or filament current from an external source. The internal structure of the tube is designed so that when sufficient voltage is applied to the tube, ionization of the gas occurs between the anode which is instantaneously positive and the cathode. Under normal operating voltages, ionization does not take place between the anode that is negative and the cathode so that the requirements for rectification are satisfied. The initial small flow of current through the tube is sufficient to raise the cathode temperature quickly to incandescence whereupon the cathode emits electrons. The voltage drop in such tubes is slightly higher than that of the usual hot-cathode gas rectifiers because energy is taken from the ionization discharge to keep the cathode at operating temperature. Proper operation of these rectifiers requires a minimum flow of load current at all times in order to maintain the cathode at the temperature required to supply sufficient emission.

## TRIODES

When a third electrode, called the **grid**, is placed between the cathode and plate, the tube is known as a triode, the family name for a three-electrode tube.



The grid usually consists of relatively fine wire wound on two support rods and extending the length of the cathode. The spaces between turns are comparatively large so that the passage of electrons from cathode to plate is practically unobstructed by the grid wires. The purpose of the grid is to control the flow of plate current. When a tube is used as an amplifier, a negative dc voltage is usually applied to the grid. Under this condition the grid does not draw appreciable current.

The number of electrons attracted to the plate depends on the combined effect of the grid and plate polarities. When the plate is positive, as is normal, and the dc grid voltage is made more and more negative, the plate is less able to attract electrons to it and plate current decreases. When the grid is made less and less negative (more and more positive), the plate more readily attracts electrons to it and plate current increases. Hence, when the voltage on the grid is varied in accordance with a signal, the plate current varies with the signal. Because a small voltage applied to the grid can control a comparatively large amount of plate current, the signal is amplified by the tube. Typical three-electrode tube types are the 6C4, 6J5, and 2A3.

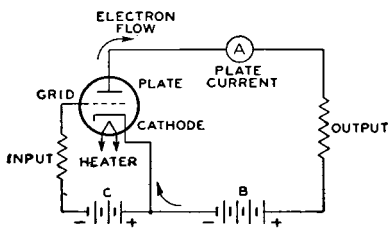

Fig. 6

The grid, plate, and cathode of a triode form an electrostatic system, each electrode acting as one plate of a small capacitor. The capacitances are those existing between grid and plate, plate and cathode, and grid and cathode. These capacitances are known as **interelectrode capacitances**. Generally, the capacitance between grid and plate is of the most importance. In high-gain radio-frequency amplifier circuits, this capacitance may act to produce undesired coupling between the **input circuit**, the circuit between grid and cathode, and the **output circuit**, the circuit between plate and cathode. This coupling is undesirable in an amplifier because it may cause instability and unsatisfactory performance.

### TETRODES

The capacitance between grid and plate can be made small by mounting an additional electrode, called the screen (grid No. 2), in the tube. With the addition of the grid No.2, the tube has four electrodes and is, accordingly, called a tetrode. The screen or grid No.2 is mounted between the grid No.1 (control grid) and the plate, and acts as an electrostatic shield between them, thus reducing the grid-to-plate capacitance. The effectiveness of this shielding action is increased by connecting a bypass capacitor between screen and cathode. By means of the screen and this bypass capacitor, the grid-plate capacitance of a tetrode is made very small. In practice, the grid-plate capacitance is reduced from several micromicrofarads ( $\mu\mu\text{f}$ ) for a triode to 0.01  $\mu\mu\text{f}$  or less for a screen-grid tube.

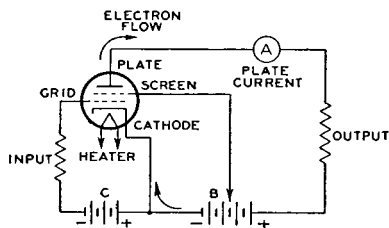

Fig. 7

The screen has another desirable effect in that it makes plate current practically independent of plate voltage over a certain range. The screen is operated at a positive voltage and, therefore, attracts electrons from the cathode. However, because of the comparatively large space between wires of the screen, most of the electrons drawn to the screen pass through it to the plate. Hence the screen supplies an electrostatic force pulling electrons from the cathode to the plate. At the same

time the screen shields the electrons between cathode and screen from the plate so that the plate exerts very little electrostatic force on electrons near the cathode. So long as the plate voltage is higher than the screen voltage, plate current in a screen-grid tube depends to a great degree on the screen voltage and very little on the plate voltage. The fact that plate current in a screen-grid tube is largely independent of plate voltage makes it possible to obtain much higher amplification with a tetrode than with a triode. The low grid-plate capacitance makes it possible to obtain this high amplification without plate-to-grid feedback and resultant instability. A representative tetrode is the 24-A.

### PENTODES

In all electron tubes, electrons striking the plate may, if moving at sufficient speed, dislodge other electrons. In two- and three-electrode types, these dislodged electrons usually do not cause trouble because no positive electrode other than the plate itself is present to attract them. These electrons, therefore, are drawn back to the plate. Emission caused by bombardment of an electrode by electrons from the cathode is called **secondary emission** because the effect is secondary to the original cathode emission. In the case of screen-grid tubes, the proximity of the positive screen to the plate offers a strong attraction to these secondary electrons and particularly so if the plate voltage swings lower than the screen voltage. This effect lowers the plate current and limits the useful plate-voltage swing for tetrodes.

The effects of secondary emission are minimized when a fifth electrode is placed within the tube between the screen and plate. This fifth electrode is known as the **suppressor** (grid No.3) and is usually connected to the cathode. Because of

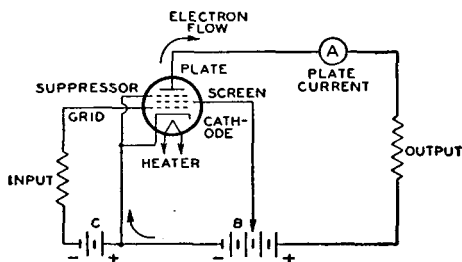

Fig. 8

its negative potential with respect to the plate, the suppressor retards the flight of secondary electrons and diverts them back to the plate. The family name for a five-electrode tube is "pentode". In power-output pentodes, the suppressor makes possible higher power output with lower grid-driving voltage; in radio-frequency amplifier pentodes the suppressor makes possible high voltage amplification at moderate values of plate voltage. These desirable features result from the fact that the plate-voltage swing can be made very large. In fact, the plate voltage may be as low as, or lower than, the screen voltage without serious loss in signal-gain capability. Representative pentodes used for power amplification are the 3V4 and 6K6-GT; representative pentodes used for voltage amplification are the 1U4, 6SJ7, 12SK7, and 6BA6.

### BEAM POWER TUBES

A **beam power tube** is a tetrode or pentode in which directed electron beams are used to increase substantially the power-handling capability of the tube. Such a tube contains a cathode, a control grid (grid No.1), a screen (grid No.2), a plate,

and, optionally, a suppressor (grid No.3). When a beam power tube is designed without an actual suppressor grid, the electrodes are so spaced that secondary emission from the plate is suppressed by space-charge effects between screen and plate. The space charge is produced by the slowing up of electrons traveling from a high-potential screen to a lower-potential plate. In this low-velocity region, the space charge produced is sufficient to repel secondary electrons emitted from the plate and to cause them to return to the plate. Beam power tubes of this design employ beam-confining electrodes at cathode potential to assist in producing the desired beam effects and to prevent stray electrons from the plate from returning to the screen outside of the beam. A feature of a beam power tube is its low screen current. The screen and the grid are spiral wires wound so that each turn of the screen is shaded from the cathode by a grid turn. This alignment of the screen and grid causes the electrons to travel in sheets between the turns of the screen so that very few of them strike the screen. Because of the effective suppressor action provided by space charge and because of the low current drawn by the screen, the beam power tube has the advantages of high power output, high power sensitivity, and high efficiency.

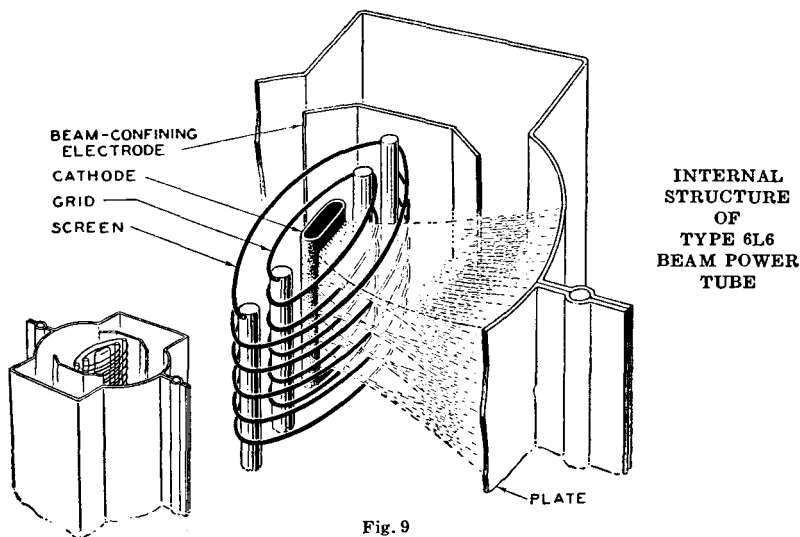

Fig. 9

Fig. 9 shows the structure of a beam power tube employing space-charge suppression and illustrates how the electrons are confined to beams. The beam condition illustrated is that for a plate potential less than the screen potential. The high-density space-charge region is indicated by the heavily dashed lines in the beam. Note that the edges of the beam-confining electrodes coincide with the dashed portion of the beam. In this way the space-charge potential region is extended beyond the beam boundaries and stray secondary electrons are prevented from returning to the screen outside of the beam. The space-charge effect may also be obtained by use of an actual suppressor grid. Examples of beam power tubes are 6L6, 6V6-GT, and 50C5.

### MULTI-ELECTRODE and MULTI-UNIT TUBES

Early in the history of tube development and application, tubes were designed for general service; that is, a single tube type—a triode—was used as a radio-frequency amplifier, an intermediate-frequency amplifier, an audio-frequency amplifier, an oscillator, or a detector. Obviously, with this diversity of application, one tube did not meet all requirements to the best advantage.

Later and present trends of tube design are the development of "specialty" types. These types are intended either to give optimum performance in a particular application or to combine in one bulb functions which formerly required two or more tubes. The first class of tubes includes such examples of specialty types as the 6F6, 12SK7, 6L7, and 6K8. Types of this class generally require more than three electrodes to obtain the desired special characteristics and may be broadly classed as multi-electrode types. The 6L7 is an especially interesting type in this class. This tube has an unusually large number of electrodes, namely seven, exclusive of the heater. Plate current in the tube is varied at two different frequencies at the same time. The tube is designed primarily for use as a mixer in superheterodyne receivers. In this use, the tube mixes the signal frequency with the oscillator frequency to give an intermediate-frequency output.

Tubes of the multi-electrode class often present interesting possibilities of application besides the one for which they are primarily designed. The 6L7, for instance, can also be used as a variable-gain audio amplifier in volume-expander and compressor application. The 6F6, besides its use as a power-output pentode, can also be connected as a triode and used as a driver for a pair of 6L6's.

The second class includes multi-unit tubes such as the twin-diode triodes 6BF6 and 6SQ7, as well as the twin-diode pentode 12C8 and the twin class A and class B types 12AU7 and 6N7, respectively. In this class also is included the multi-unit type 117L7/M7-GT. This tube combines in one bulb a diode for use as a power rectifier and a power-output pentode. Related to multi-unit tubes are the electron-ray types 6AB5/6N5 and 6AL7-GT. These combine a triode amplifier with a fluorescent target. Full-wave rectifiers are also multi-unit types.

A third class of tubes combines features of each of the other two classes. Typical of this third class are the pentagrid-converter types 1R5, 6BE6, and 6SA7. These tubes are similar to the multi-electrode types in that they have seven electrodes, all of which affect the electron stream; and they are similar to the multi-unit tubes in that they perform simultaneously the double function of oscillator and mixer in superheterodyne receivers.

## KINESCOPES

The kinescope is a multi-electrode tube used principally in television receivers for picture display. It consists essentially of an electron gun, a glass or metal-and-glass envelope and face-plate combination, and a fluorescent screen.

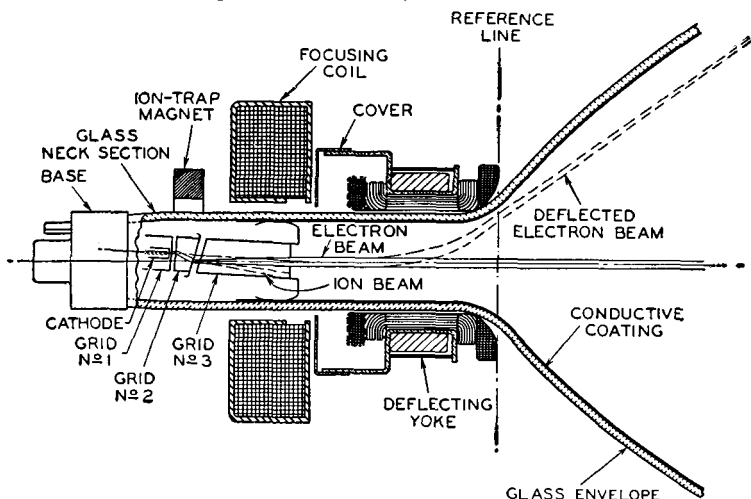

Fig. 10

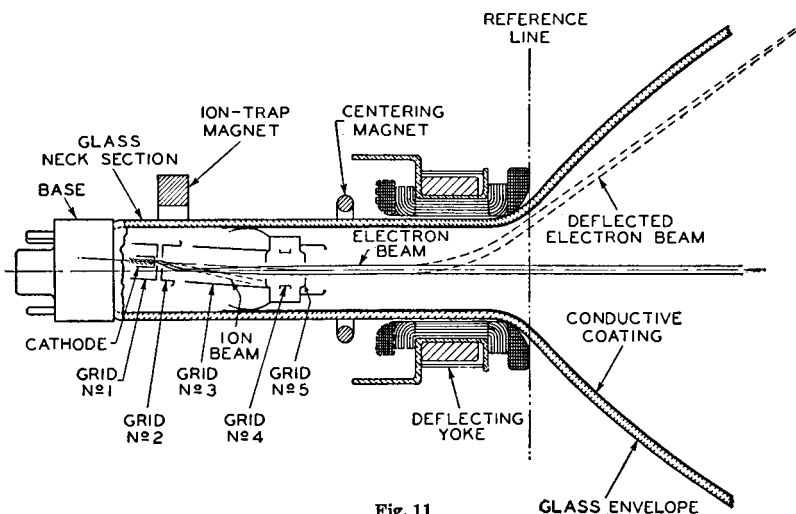

Fig. 11

The electron gun includes a cathode for the production of free electrons, an electron "lens" system for accelerating the electrons and forming or focusing them into a very narrow beam, and, optionally, a device for "trapping" unwanted ions out of the electron beam.

Deflection of the beam is accomplished either electrostatically by means of deflecting electrodes within the envelope of the tube, or electromagnetically by means of a deflecting yoke placed on the neck of the tube. Figs. 10 and 11 show the structure of the gun section of a kinescope and illustrate how the electron beam is formed, how the ions are separated from the electron beam by means of the tilted-gun and ion-trap-magnet arrangement, and how the beam is deflected by means of an electromagnetic deflecting yoke.

Focusing of the beam is accomplished either electromagnetically by means of a focusing coil placed on the neck of the tube, as shown in Fig. 10, or electrostatically by means of focusing electrodes within the envelope of the tube. In the tube shown in Fig. 11, the focusing electrodes are grids No. 4 and No. 5.

The screen is a white-fluorescing phosphor P4 of either the silicate or the sulfide type. The spectral distribution of the energy emitted by each type of phosphor is shown by the curves on page 249. The persistence of the phosphorescence exhibited by either type of the phosphor P4 is such that its brightness does not exceed 7 per cent of the peak value in 33 milliseconds after excitation is removed.

The tricolor kinescope 15GP22 consists of three electron guns and a plane, tricolor, Filterglass phosphor-dot (screen) plate located between a shadow mask and a clear-glass faceplate. It utilizes electrostatic convergence, electrostatic focus, and magnetic deflection. The spectral distribution of the energy emitted by the group phosphor P22 used in this type is shown by the curve on page 249. The persistence of the group phosphorescence is such that its brightness does not exceed 7 per cent of the peak value in 33 milliseconds after excitation is removed.

# Electron Tube Characteristics

The term "characteristics" is used to identify the distinguishing electrical features and values of an electron tube. These values may be shown in curve form or they may be tabulated. When the characteristics values are given in curve form, the curves may be used for the determination of tube performance and the calculation of additional tube factors.

Tube characteristics are obtained from electrical measurements of a tube in various circuits under certain definite conditions of voltages. Characteristics may be further described by denoting the conditions of measurements. For example Static Characteristics are the values obtained with different dc potentials applied to the tube electrodes, while Dynamic Characteristics are the values obtained with an ac voltage on a control grid under various conditions of dc potentials on the electrodes. The dynamic characteristics, therefore, are indicative of the performance capabilities of a tube under actual working conditions.

Static characteristics may be shown by plate characteristics curves and transfer (mutual) characteristics curves. These curves present the same information, but in two different forms to increase its usefulness. The plate characteristic curve

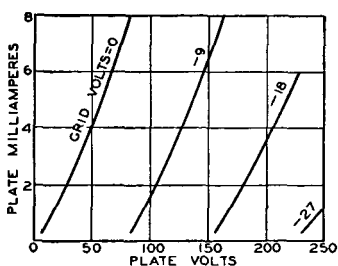

Fig. 12

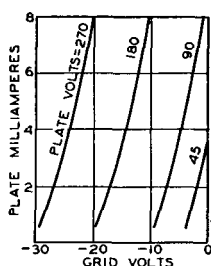

Fig. 13

is obtained by varying plate voltage and measuring plate current for different grid bias voltages, while the transfer-characteristic curve is obtained by varying grid bias voltage and measuring plate current for different plate voltages. A plate-characteristic family of curves is illustrated by Fig. 12. Fig. 13 gives the transfer-characteristic family of curves for the same tube.

Dynamic characteristics include amplification factor, plate resistance, control-grid—plate transconductance, and certain detector characteristics, and may be shown in curve form for variations in tube operating conditions.

The **amplification factor**, or  $\mu$ , is the ratio of the change in plate voltage to a change in control-electrode voltage in the opposite direction, under the condition that the plate current remains unchanged and that all other electrode voltages are maintained constant. For example, if, when the plate voltage is made 1 volt more positive, the control-electrode (grid-No.1) voltage must be made 0.1 volt more negative to hold plate current unchanged, the amplification factor is 1 divided by 0.1, or 10. In other words, a small voltage variation in the grid circuit of a tube has the same effect on the plate current as a large plate-voltage change—the latter equal to the product of the grid-voltage change and amplification factor. The  $\mu$  of a tube is often useful for calculating stage gain. This use is discussed in the ELECTRON TUBE APPLICATIONS SECTION.

**Plate resistance** ( $r_p$ ) of an electron tube is the resistance of the path between cathode and plate to the flow of alternating current. It is the quotient of a small change in plate voltage divided by the corresponding change in plate current and is

expressed in ohms, the unit of resistance. Thus, if a change of 0.1 milliampere (0.0001 ampere) is produced by a plate voltage variation of 1 volt, the plate resistance is 1 divided by 0.0001, or 10000 ohms.

**Control-grid—plate transconductance**, or simply **transconductance** ( $g_m$ ), is a factor which combines in one term the amplification factor and the plate resistance, and is the quotient of the first divided by the second. This term has also been known as mutual conductance. Transconductance may be more strictly defined as the quotient of a small change in plate current (amperes) divided by the small change in the control-grid voltage producing it, under the condition that all other voltages remain unchanged. Thus, if a grid-voltage change of 0.5 volt causes a plate-current change of 1 milliampere (0.001 ampere), with all other voltages constant, the transconductance is 0.001 divided by 0.5, or 0.002 mho. A "mho" is the unit of conductance and was named by spelling ohm backwards. For convenience, a millionth of a mho, or a micromho ( $\mu\text{mho}$ ), is used to express transconductance. Thus, in the example, 0.002 mho is 2000 micromhos.

**Conversion transconductance** ( $g_c$ ) is a characteristic associated with the mixer (first detector) function of tubes and may be defined as the quotient of the intermediate-frequency (if) current in the primary of the if transformer divided by the applied radio-frequency (rf) voltage producing it; or more precisely, it is the limiting value of this quotient as the rf voltage and if current approach zero. When the performance of a frequency converter is determined, conversion transconductance is used in the same way as control-grid—plate transconductance is used in single-frequency amplifier computations.

The **plate efficiency** of a power amplifier tube is the ratio of the ac power output to the product of the average dc plate voltage and dc plate current at full signal, or

$$\text{Plate efficiency (\%)} = \frac{\text{power output watts}}{\text{average dc plate volts} \times \text{average dc plate amperes}} \times 100$$

The **power sensitivity** of a tube is the ratio of the power output to the square of the input signal voltage (rms) and is expressed in mhos as follows:

$$\text{Power sensitivity (mhos)} = \frac{\text{power output watts}}{(\text{input signal volts, rms})^2}$$

# Electron Tube Applications

The diversified applications of an electron receiving tube have, within the scope of this section, been treated under eight headings. These are: Amplification, Rectification, Detection, Automatic Volume Control, Tuning Indication with Electron-Ray Tubes, Oscillation, Frequency Conversion, and Automatic Frequency Control. Although these operations may take place at either radio or audio frequencies and may involve the use of different circuits and different supplemental parts, the general considerations of each kind of operation are basic.

## AMPLIFICATION

The amplifying action of an electron tube was mentioned under **Triodes** in the section on **ELECTRONS, ELECTRODES, and ELECTRON TUBES**.

This action can be utilized in electronic circuits in a number of ways, depending upon the results desired. Four classes of amplifier service recognized by engineers are covered by definitions standardized by the Institute of Radio Engineers. This classification depends primarily on the fraction of input cycle during which plate current is expected to flow under rated full-load conditions. The classes are class A, class AB, class B, and class C. The term "cutoff bias" used in these definitions is the value of grid bias at which plate current is some very small value.

**Class A Amplifier.** A class A amplifier is an amplifier in which the grid bias and alternating grid voltages are such that plate current in a specific tube flows at all times.

**Class AB Amplifier.** A class AB amplifier is an amplifier in which the grid bias and alternating grid voltages are such that plate current in a specific tube flows for appreciably more than half but less than the entire electrical cycle.

**Class B Amplifier.** A class B amplifier is an amplifier in which the grid bias is approximately equal to the cutoff value, so that the plate current is approximately zero when no exciting grid voltage is applied, and so that plate current in a specific tube flows for approximately one-half of each cycle when an alternating grid voltage is applied.

**Class C Amplifier.** A class C amplifier is an amplifier in which the grid bias is appreciably greater than the cutoff value, so that the plate current in each tube is zero when no alternating grid voltage is applied, and so that plate current flows in a specific tube for appreciably less than one-half of each cycle when an alternating grid voltage is applied.

**NOTE:**—To denote that grid current does not flow during any part of the input cycle, the suffix 1 may be added to the letter or letters of the class identification. The suffix 2 may be used to denote that grid current flows during some part of the cycle.

For radio-frequency amplifiers which operate into a selective tuned circuit, as in radio transmitter applications, or under requirements where distortion is not an important factor, any of the above classes of amplifiers may be used, either with a single tube or a push-pull stage. For audio-frequency amplifiers in which distortion is an important factor, only class A amplifiers permit single-tube operation. In this case, operating conditions are usually chosen so that distortion is kept below the conventional 5 per cent for triodes and the conventional 7 to 10 per cent for tetrodes or pentodes. Distortion can be reduced below these figures by means of special circuit arrangements such as that discussed under **inverse feedback**. With class A amplifiers, reduced distortion with improved power performance can be obtained by using a push-pull stage for audio service. With class AB and class B amplifiers, a balanced amplifier stage using two tubes is required for audio service.

As a **class A voltage amplifier**, an electron tube is used to reproduce grid voltage variations across an impedance or a resistance in the plate circuit. These variations are essentially of the same form as the input signal voltage impressed on the



grid, but their amplitude is increased. This increase is accomplished by operating the tube at a suitable grid bias so that the applied grid input voltage produces plate-current variations proportional to the signal swings. Because the voltage variation obtained in the plate circuit is much larger than that required to swing the grid, amplification of the signal is obtained. Fig. 14 gives a graphical illustration of this method of amplification and shows, by means of the grid-voltage vs. plate-current characteristics curve, the effect of an input signal (S) applied to the grid of a tube. O is the resulting amplified plate-current variation.

The plate current flowing through the load resistance (R) of Fig. 15 causes a voltage drop which varies directly with the plate current. The ratio of this voltage variation produced in the load resistance to the input signal voltage is the voltage

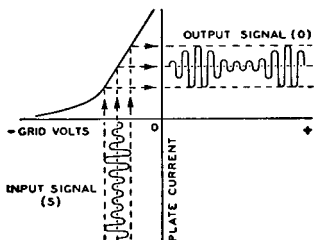

Fig. 14

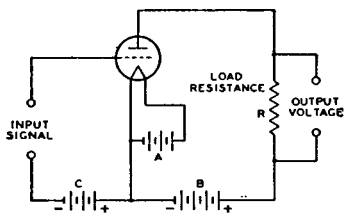

Fig. 15

amplification, or **gain**, provided by the tube. The voltage amplification due to the tube is expressed by the following convenient formulas:

$$\text{Voltage amplification} = \frac{\text{amplification factor} \times \text{load resistance}}{\text{load resistance} + \text{plate resistance}}, \text{ or}$$

$$\frac{\text{transconductance in micromhos} \times \text{plate resistance} \times \text{load resistance}}{1000000 \times (\text{plate resistance} + \text{load resistance})}$$

From the first formula, it can be seen that the gain actually obtainable from the tube is less than the tube's amplification factor but that the gain approaches the amplification factor when the load resistance is large compared to the tube's plate resistance. Fig. 16 shows graphically how the gain approaches the amplification factor of the tube as the load resistance is increased. From the curve it can be seen that a high value of load resistance should be used to obtain high gain in a voltage amplifier.

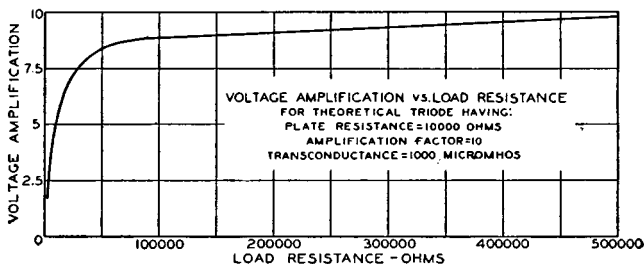

Fig. 16

In a **resistance-coupled amplifier**, the load resistance of the tube is approximately equal to the resistance of the plate resistor in parallel with the grid resistor of the following stage. Hence, to obtain a large value of load resistance, it is necessary to use a plate resistor and a grid resistor of large resistance. However, the plate resistor should not be too large because the flow of plate current through the plate resistor produces a voltage drop which reduces the plate voltage applied to the tube. If the plate resistor is too large, this drop will be too large, the plate voltage on the

tube will be too small, and the voltage output of the tube will be too small. Also, the grid resistor of the following stage should not be too large, the actual maximum value being dependent on the particular tube type. This precaution is necessary because all tubes contain minute amounts of residual gas which cause a minute flow of current through the grid resistor. If the grid resistor is too large, the positive bias developed by the flow of this current through the resistor decreases the normal negative bias and produces an increase in the plate current. This increased current may overheat the tube and cause liberation of more gas which, in turn, will cause further decrease in bias. The action is cumulative and results in a runaway condition which can destroy the tube. A higher value of grid resistance is permissible when cathode bias is used than when fixed bias is used. When cathode bias is used, a loss in bias due to gas or grid-emission effects is almost completely offset by an increase in bias due to the voltage drop across the cathode resistor. Typical values of plate resistor and grid resistor for tube types used in resistance-coupled circuits, and the values of gain obtainable, are shown in the RESISTANCE-COUPLED AMPLIFIER SECTION.

The **input impedance** of an electron tube (that is, the impedance between grid and cathode) consists of (1) a reactive component due to the capacitance between grid and cathode, (2) a resistive component resulting from the time of transit of electrons between cathode and grid, and (3) a resistive component developed by the part of the cathode lead inductance which is common to both the input and output circuits. Components (2) and (3) are dependent on the frequency of the incoming signal. The input impedance is very high at audio frequencies when a tube is operated with its grid biased negative. In a class  $A_1$  or class  $AB_1$  transformer-coupled audio amplifier, therefore, the loading imposed by the grid on the input transformer is negligible. As a result, the secondary impedance of a class  $A_1$  or class  $AB_1$  input transformer can be made very high because the choice is not limited by the input impedance of the tube; however, transformer design considerations may limit the choice. At the higher radio frequencies, the input impedance may become very low even when the grid is negative, due to the finite time of passage of electrons between cathode and grid and to the appreciable lead reactance. This impedance drops very rapidly as the frequency is raised, and increases input-circuit loading. In fact, the input impedance may become low enough at very high radio frequencies to affect appreciably the gain and selectivity of a preceding stage. Tubes such as the "acorn" types and the high-frequency miniatures have been developed to have low input capacitances, low electron-transit time, and low lead inductance so that their input impedance is high even at the ultra-high radio frequencies. **Input admittance** is the reciprocal of input impedance.

A **remote-cutoff amplifier** tube is a modified construction of a pentode or a tetrode type designed to reduce modulation-distortion and cross-modulation in radio-frequency stages. **Cross-modulation** is the effect produced in a radio receiver by an interfering station "riding through" on the carrier of the station to which the receiver is tuned. **Modulation-distortion** is a distortion of the modulated carrier and appears as audio-frequency distortion in the output. This effect is produced by a radio-frequency amplifier stage operating on an excessively curved characteristic when the grid bias has been increased to reduce volume. The offending stage for cross-modulation is usually the first radio-frequency amplifier, while for modulation-distortion the cause is usually the last intermediate-frequency stage. The characteristics of remote-cutoff types are such as to enable them to handle both large and small input signals with minimum distortion over a wide range of signal strength.

Fig. 17 illustrates the construction of the grid No.1 (control grid) in a remote-cutoff tube. The remote-cutoff action is due to the structure of the grid which provides a variation in amplification factor with change in grid bias. The grid No.1 is wound with open spacing at the middle and with close spacing at the ends. When

weak signals and low grid bias are applied to the tube, the effect of the non-uniform turn spacing of the grid on cathode emission and tube characteristics is essentially the same as for uniform spacing. As the grid bias is made more negative to handle larger input signals, the electron flow from the sections of the cathode enclosed by the ends of the grid is cut off. The plate current and other tube characteristics are then dependent on the electron flow through the open section of the grid. This

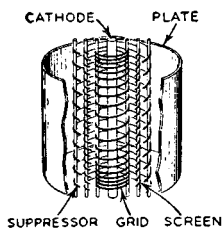

Fig. 17

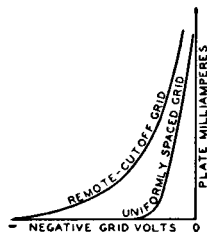

Fig. 18

action changes the gain of the tube so that large signals may be handled with minimum distortion due to cross-modulation and modulation-distortion. Fig. 18 shows a typical plate-current vs. grid-voltage curve for a remote-cutoff type compared with the curve for a type having a uniformly spaced grid. It will be noted that while the curves are similar at small grid-bias voltages, the plate current of the remote-cutoff tube drops quite slowly with large values of bias voltage. This slow change makes it possible for the tube to handle large signals satisfactorily. Because remote-cutoff types can accommodate large and small signals, they are particularly suitable for use in sets having automatic volume control. Remote-cutoff tubes also are known as variable- $\mu$  types. The 6SK7 is a representative remote-cutoff type.

As a class A power amplifier, an electron tube is used in the output stage of a radio receiver to supply a relatively large amount of power to the loudspeaker. For this application, large power output is of more importance than high voltage amplification; therefore, gain possibilities are sacrificed in the design of power tubes to obtain power-handling capability. Triodes, pentodes, and beam power tubes designed for power amplifier service have certain inherent features for each structure. Power tubes of the triode type for class A service are characterized by low power sensitivity, low plate-power efficiency, and low distortion. Power tubes of the pentode type are characterized by high power sensitivity, high plate-power efficiency and, usually, somewhat higher distortion than class A triodes. Beam power tubes such as the 6L6 have higher power sensitivity and efficiency than triode or conventional pentode types.

A class A power amplifier is also used as a driver to supply power to a class AB<sub>2</sub> or a class B stage. It is usually advisable to use a triode, rather than a pentode, in a driver stage because of the lower plate impedance of the triode.

Power tubes connected in either parallel or push-pull may be employed as class A amplifiers to obtain increased output. The parallel connection (Fig. 19) provides twice the output of a single tube with the same value of grid-signal voltage. With this connection, the effective transconductance of the stage is doubled, and the effective plate resistance and the load resistance required are halved as compared with single-tube values. The push-pull connection (Fig. 20), although it requires twice the grid-signal voltage, provides increased power and has other important advantages over single-tube operation. Distortion caused by even-order harmonics and hum caused by plate-voltage-supply fluctuations are either eliminated or decidedly reduced through cancellation. Because distortion for push-pull operation is less than for single-tube operation, appreciably more than twice single-tube output can be obtained with triodes by decreasing the load resistance for the stage to a value approaching the load resistance for a single tube. For either parallel

or push-pull class A operation of two tubes, all electrode currents are doubled while all dc electrode voltages remain the same as for single-tube operation. If a cathode resistor is used, its value should be about one-half that for a single tube. If oscillations occur with either type of connection, they can often be eliminated by connecting a non-inductive resistor of approximately 100 ohms in series with each grid at the socket terminal.

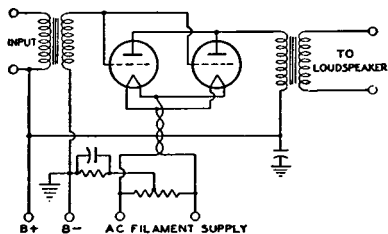

Fig. 19

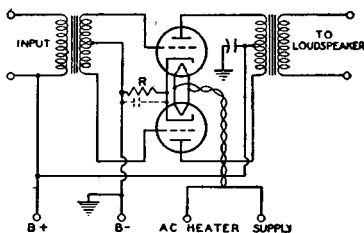

Fig. 20

Operation of power tubes so that the grids run positive is inadvisable except under conditions such as those discussed in this section for class AB and class B amplifiers.

Calculation of the **power output of a triode** used as a class A amplifier with either an output transformer or a choke having low dc resistance can be made without serious error from the plate family of curves by assuming a resistance load. The proper plate current, grid bias, optimum load resistance, and per-cent second-harmonic distortion can also be determined. The calculations are made graphically and are illustrated in Fig. 21 for given conditions. The procedure is as follows: (1) Locate the zero-signal bias point P by determining the zero-signal bias  $E_{c0}$  from the formula:

$$\text{Zero-signal bias } (E_{c0}) = -(0.68 \times E_b) / \mu$$

where  $E_b$  is the chosen value in volts of dc plate voltage at which the tube is to be operated, and  $\mu$  is the amplification factor of the tube. This quantity is shown as negative to indicate that a negative bias is used. (2) Locate on the plate family the value of zero-signal plate current,  $I_0$ , corresponding to point P. (3) Locate  $2I_0$ , which is twice the value of  $I_0$  and corresponds to the value of the maximum-signal plate current  $I_{max}$ . (4) Locate the point X on the dc bias curve at zero volts,  $E_c = 0$ , corresponding to the value of  $I_{max}$ . (5) Draw a straight line XY through X and P.

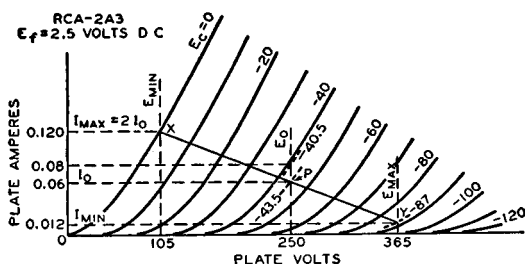

Fig. 21

Line XY is known as the load resistance line. Its slope corresponds to the value of the load resistance. The load resistance in ohms is equal to  $(E_{max} - E_{min})$  divided by  $(I_{max} - I_{min})$ , where E is in volts and I is in amperes.

It should be noted that in the case of filament types of tubes, the calculations are given on the basis of a dc-operated filament. When the filament is ac-operated, the calculated value of dc bias should be increased by approximately one-half the filament voltage rating of the tube.

The value of zero-signal plate current  $I_0$  should be used to determine the plate dissipation, an important factor influencing tube life. In a class A amplifier under zero-signal conditions, the plate dissipation is equal to the power input, i.e., the product of the dc plate voltage  $E_0$  and the zero-signal dc plate current  $I_0$ . If it is found that the plate-dissipation rating of the tube is exceeded with the zero-signal bias  $E_{c0}$  calculated above, it will be necessary to increase the bias by a sufficient amount so that the actual plate dissipation does not exceed the rating before proceeding further with the remaining calculations.

For power output calculations, it is assumed that the peak alternating grid voltage is sufficient (1) to swing the grid from the zero-signal bias value  $E_{c0}$  to zero bias ( $E_c = 0$ ) on the positive swing and (2) to swing the grid to a value twice the zero-signal bias value on the negative swing. During the negative swing, the plate voltage and plate current reach values of  $E_{max}$  and  $I_{min}$ ; during the positive swing, they reach values of  $E_{min}$  and  $I_{max}$ . Because power is the product of voltage and current, the power output as shown by a wattmeter is given by

$$\text{Power output} = \frac{(I_{max} - I_{min})(E_{max} - E_{min})}{8}$$

where  $E$  is in volts,  $I$  is in amperes, and power output is in watts.

In the output of power amplifier triodes, some distortion is present. This distortion is due predominantly to second harmonics in single-tube amplifiers. The percentage of second-harmonic distortion may be calculated by the following formula:

$$\% \text{ 2nd-harmonic distortion} = \frac{\frac{I_{max} + I_{min}}{2} - I_0}{I_{max} - I_{min}} \times 100$$

where  $I_0$  is the zero-signal plate current in amperes. If the distortion is excessive, the load resistance should be increased or, occasionally, decreased slightly and the calculations repeated.

**Example:** Determine the load resistance, power output, and distortion of a triode having an amplification factor of 4.2, a plate-dissipation rating of 15 watts, and plate characteristics curves as shown in Fig. 21. The tube is to be operated at 250 volts on the plate.

**Procedure:** For a first approximation, determine the operating point P from the zero-signal bias formula,  $E_{c0} = -(0.68 \times 250) / 4.2 = -40.5$  volts. From the curve for this voltage, it is found that the zero-signal plate current  $I_0$  at a plate voltage of 250 volts is 0.08 ampere and, therefore, the plate-dissipation rating is exceeded ( $0.08 \times 250 = 20$  watts). Consequently, it is necessary to reduce the zero-signal plate current to 0.06 ampere at 250 volts. The grid bias is now seen to be -43.5 volts. Note that the curve was taken with a dc filament supply; if the filament is to be operated on an ac supply, the bias must be increased by about one-half the filament voltage, or to -45 volts, and the circuit returns made to the mid-point of the filament circuit.

Point X can now be determined. Point X is at the intersection of the dc bias curve at zero volts with  $I_{max}$ , where  $I_{max} = 2I_0 = 2 \times 0.06 = 0.12$  ampere. Line XY is drawn through points P and X.  $E_{max}$ ,  $E_{min}$ , and  $I_{min}$  are then found from the curves. Substituting these values in the power output formula, we obtain

$$\text{Power output} = \frac{(0.12 - 0.012)(365 - 105)}{8} = 3.52 \text{ watts}$$

The resistance represented by load line XY is

$$\frac{(365 - 105)}{(0.12 - 0.012)} = 2410 \text{ ohms}$$

When the values from the curves are substituted in the distortion formula, we obtain

$$\% \text{ 2nd-harmonic distortion} = \frac{0.12 + 0.012}{2} - 0.06 \div \frac{0.12 - 0.012}{2} \times 100 = 5.5\%$$

It is customary to select the load resistance so that the distortion does not exceed five per cent. When the method shown is used to determine the slope of the load resistance line, the second-harmonic distortion generally does not exceed five per cent. In the example, however, the distortion is excessive and it is desirable, therefore, to use a slightly higher load resistance. A load resistance of 2500 ohms will give a distortion of about 4.9 per cent. The power output is reduced only slightly to 3.5 watts.

Operating conditions for triodes in push-pull depend on the type of operation desired. Under class A conditions, distortion, power output, and efficiency are all relatively low. The operating bias can be anywhere between that specified for single-tube operation and that equal to one-half the grid-bias voltage required to produce plate-current cutoff at a plate voltage of  $1.4E_0$  where  $E_0$  is the operating plate voltage. Higher bias than this value requires higher grid-signal voltage and results in class AB<sub>1</sub> operation which is discussed later.

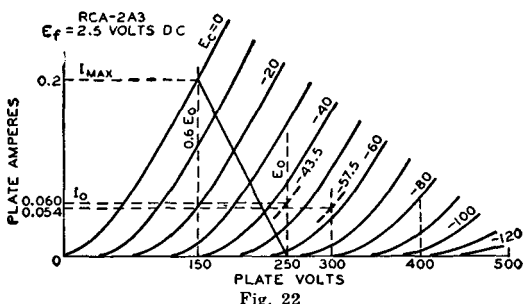

The method for calculating maximum power output for triodes in push-pull class A operation is as follows: Erect a vertical line at  $0.6E_0$  (see Fig. 22), intersecting the  $E_c=0$  curve at the point  $I_{max}$ . Then,  $I_{max}$  is determined from the curve for use in the formula

$$\text{Power output} = (I_{max} \times E_0)/5$$

If  $I_{max}$  is expressed in amperes and  $E_0$  in volts, power output is in watts.

The method for determining the proper load resistance for triodes in push-pull is as follows: Draw a load line through  $I_{max}$  on the zero-bias curve and through the  $E_0$  point on the zero-current axis. Four times the resistance represented by this load line is the plate-to-plate load for two triodes in a class A push-pull amplifier. Expressed as a formula,

$$\text{Plate-to-plate load } (R_{pp}) = 4 \times (E_0 - 0.6E_0)/I_{max}$$

where  $E_0$  is expressed in volts,  $I_{max}$  in amperes, and  $R_{pp}$  in ohms.

**Example:** Assume that the plate voltage ( $E_0$ ) is to be 300 volts, and the plate dissipation rating of the tube is 15 watts. Then, for class A operation, the operating bias can be equal to, but not more than, one-half the grid bias for cutoff with a plate

voltage of  $1.4 \times 300 = 420$  volts. (Since cutoff bias is approximately  $-115$  volts at a plate voltage of 420 volts, one-half of this value is  $-57.5$  volts bias.) At this bias, the plate current is found from the plate family to be 0.054 ampere and, therefore, the plate dissipation is  $0.054 \times 300$  or 16.2 watts. Since  $-57.5$  volts is the limit of bias for class A operation of these tubes at a plate voltage of 300 volts, the dissipation cannot be reduced by increasing the bias and it, therefore, becomes necessary to reduce the plate voltage.

If the plate voltage is reduced to 250 volts, the bias will be found to be  $-43.5$  volts. For this value, the plate current is 0.06 ampere, and the plate dissipation is 15 watts. Then, following the method for calculating power output, erect a vertical line at  $0.6E_0 = 150$  volts. The intersection of the line with the curve  $E_c = 0$  is  $I_{max}$  or 0.2 ampere. When this value is substituted in the power formula, the power output is  $(0.2 \times 250)/5 = 10$  watts. The load resistance is determined from the load formula: Plate-to-plate load ( $R_{pp}$ ) =  $4(250 - 150)/0.2 = 2000$  ohms.

**Power output for a pentode or a beam power tube as a class A amplifier** can be calculated in much the same way as for triodes. The calculations can be made graphically from a special plate family of curves, as illustrated in Fig. 23.

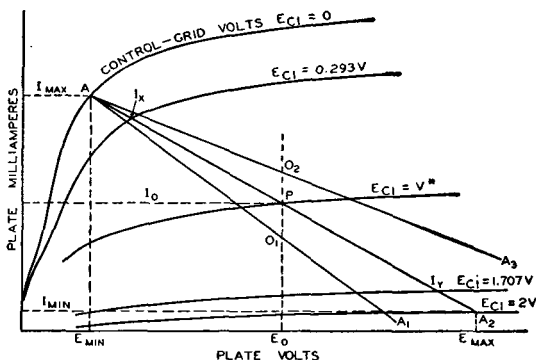

\*V is the Negative Control-Grid Bias Voltage at the Operating Point

Fig. 23

From a point A at or just below the knee of the zero-bias curve, draw arbitrarily selected load lines to intersect the zero-plate-current axis. These lines should be on both sides of the operating point P whose position is determined by the desired operating plate voltage,  $E_0$ , and one-half the maximum-signal plate current. Along any load line, say  $AA_1$ , measure the distance  $AO_1$ . On the same line, lay off an equal distance  $O_1A_1$ . For optimum operation, the change in bias from A to  $O_1$  should be nearly equal to the change in bias from  $O_1$  to  $A_1$ . If this condition can not be met with one line, as is the case for the line first chosen, then another should be chosen. When the most satisfactory line has been selected, its resistance may be determined by the following formula:

$$\text{Load resistance } (R_p) = \frac{E_{max} - E_{min}}{I_{max} - I_{min}}$$

The value of  $R_p$  may then be substituted in the following formula for calculating power output.

$$\text{Power output} = \frac{[I_{max} - I_{min} + 1.41 (I_x - I_y)]^2 R_p}{32}$$

In both of these formulas, I is in amperes, E is in volts,  $R_p$  is in ohms, and power output is in watts.  $I_x$  and  $I_y$  are the current values on the load line at bias voltages of  $E_{c1} = V - 0.707V = 0.293V$  and  $E_{c1} = V + 0.707V = 1.707V$ , respectively.

Calculations for distortion may be made by means of the following formulas. The terms used have already been defined.

$$\% \text{ 2nd-harmonic distortion} = \frac{I_{\max} + I_{\min} - 2 I_0}{I_{\max} - I_{\min} + 1.41 (I_x - I_y)} \times 100$$

$$\% \text{ 3rd-harmonic distortion} = \frac{I_{\max} - I_{\min} - 1.41 (I_x - I_y)}{I_{\max} - I_{\min} + 1.41 (I_x - I_y)} \times 100$$

$$\% \text{ total (2nd and 3rd) harmonic distortion} = \sqrt{(\%2\text{nd})^2 + (\%3\text{rd})^2}$$

The **conversion curves** given in Fig. 24 apply to electron tubes in general but are particularly useful for power tubes. These curves can be used for calculating approximate operating conditions for a plate voltage which is not included in the published data on operating conditions. For instance, suppose it is desired to operate two 6L6's in class A<sub>1</sub> push-pull, fixed bias, with a plate voltage of 200 volts. The nearest published operating conditions for this class of service are for a plate voltage of 250 volts. The operating conditions for the new plate voltage can be determined as follows: First compute the ratio of the new plate voltage to the plate voltage of the published data. In the example, this ratio is  $200/250 = 0.8$ . This figure is the Voltage Conversion Factor,  $F_e$ . Multiply by this factor the published values for 250-volt operation in order to obtain the new values of grid bias and screen voltage. This gives a grid bias of  $-16 \times 0.8 = -12.8$  volts, and a screen voltage of  $250 \times 0.8 = 200$  volts for the new conditions.

To obtain the rest of the new conditions, multiply the published values by factors shown on the chart as corresponding to the voltage conversion factor of 0.8. In this chart,

$F_i$  applies to plate current and to screen current,

$F_p$  applies to power output

$F_r$  applies to load resistance and plate resistance,

$F_{gm}$  applies to transconductance.

Thus, to find the power output for the new conditions, determine the value of  $F_p$  for a voltage conversion factor of 0.8. The chart shows that this value of  $F_p$  is 0.6. Multiplying the published value of power output by 0.6, the power output for the new conditions is  $14.5 \times 0.6 = 8.7$  watts.

A class AB power amplifier employs two tubes connected in push-pull with a higher negative grid bias than is used in a class A stage. With this higher negative bias, the plate and screen voltages can usually be made higher than for class A amplifiers because the increased negative bias holds plate current within the limit of the tube's plate-dissipation rating. As a result of these higher voltages, more power output can be obtained from class AB operation.

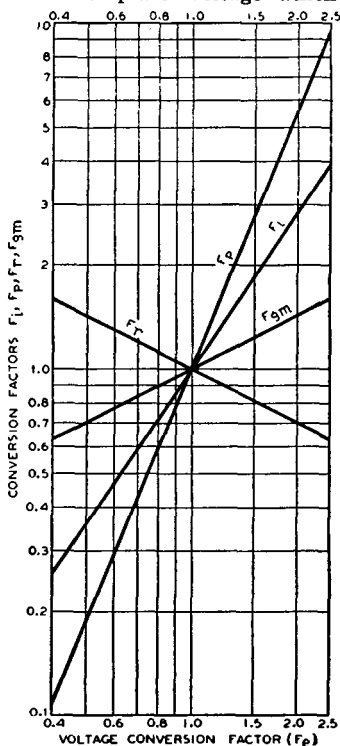

Fig. 24



Class AB amplifiers are subdivided into class AB<sub>1</sub> and class AB<sub>2</sub>. In class AB<sub>1</sub> there is no flow of grid current. That is, the peak signal voltage applied to each grid is not greater than the negative grid-bias voltage. The grids therefore are not driven to a positive potential and do not draw current. In class AB<sub>2</sub>, the peak signal voltage is greater than the bias so that the grids are driven positive and draw current.

Because of the flow of grid current in a class AB<sub>2</sub> stage there is a loss of power in the grid circuit. The sum of this loss and the loss in the input transformer is the total driving power required by the grid circuit. The driver stage should be capable of a power output considerably larger than this required power in order that distortion introduced in the grid circuit be kept low. The input transformer used in a class AB<sub>2</sub> amplifier usually has a step-down turns ratio.

Because of the large fluctuations of plate current in a class AB<sub>2</sub> stage, it is important that the plate power supply should have good regulation. Otherwise the fluctuations in plate current cause fluctuations in the voltage output of the power supply, with the result that power output is decreased and distortion is increased. To obtain satisfactory regulation it is usually advisable to use a low-drop rectifier, such as the 5V4-G, with a choke-input filter. In all cases, the resistance of the filter choke and power transformers should be as low as possible.

In class AB<sub>1</sub> push-pull amplifier service using triodes, the operating conditions may be determined graphically by means of the plate family if  $E_o$ , the desired operating plate voltage, is given. In this service, the dynamic load line does not pass through the operating point P as in the case of the single-tube amplifier, but through the point D in Fig. 25. Its position is not affected by the operating grid bias provided the plate-to-plate load resistance remains constant. Under these conditions, grid bias has no appreciable effect on the power output. Grid bias cannot be neglected, however, since it is used to find the zero-signal plate current and, from it, the zero-signal plate dissipation. Because the grid bias is higher in class AB<sub>1</sub> than in class A service for the same plate voltage, a higher signal voltage may be used without grid current being drawn and, therefore, higher power output is obtained than in class A service.

In general, for any load line through point D, Fig. 25, the plate-to-plate load resistance in ohms of a push-pull amplifier is  $R_{pp} = 4E_o/I'$ , where  $I'$  is the plate current value in amperes at which the load line as projected intersects the plate current axis, and  $E_o$  is in volts. This formula is another form of the one given under push-pull class A amplifiers,  $R_{pp} = 4(E_o - 0.6E_o)/I_{max}$ , but is more general. Power output =  $(I_{max}/\sqrt{2})^2 \times R_{pp}/4$ , where  $I_{max}$  is the peak plate current at zero grid volts for the load chosen. This formula simplified is  $(I_{max})^2 \times R_{pp}/8$ . The maximum-signal average plate current is  $2I_{max}/\pi$  or  $0.636 I_{max}$ ; the maximum-signal average power input is  $0.636 I_{max} E_o$ .

It is desirable to simplify these formulas for a first approximation. This simplification can be made if it is assumed that the peak plate current,  $I_{max}$ , occurs at the point of the zero-bias curve corresponding approximately to  $0.6E_o$ , the condition for maximum power output. The simplified formulas are:

$$\begin{aligned} \text{Power output (for two tubes)} &= (I_{max} \times E_o)/5 \\ \text{Plate-to-plate load resistance (} R_{pp} \text{)} &= 1.6E_o/I_{max} \end{aligned}$$

where  $E_o$  is in volts,  $I_{max}$  is in amperes,  $R_{pp}$  is in ohms, and power output is in watts.

It may be found during subsequent calculations that the distortion or the plate dissipation is excessive for this approximation; in that case, a different load resistance must be selected using the first approximation as a guide and the process repeated to obtain satisfactory operating conditions.

**Example:** Fig. 25 illustrates the application of this method to a pair of 2A3's operated at  $E_o=300$  volts. Each tube has a plate-dissipation rating of 15 watts. The method is to erect a vertical line at  $0.6E_o$ , or at 180 volts, which intersects the  $E_c = 0$  curve at the point  $I_{max} = 0.26$  ampere. Using the simplified formulas, we obtain

$$\text{Plate-to-plate load resistance } (R_{pp}) = (1.6 \times 300)/0.26 = 1845 \text{ ohms}$$

$$\text{Power output} = (0.26 \times 300)/5 = 15.6 \text{ watts}$$

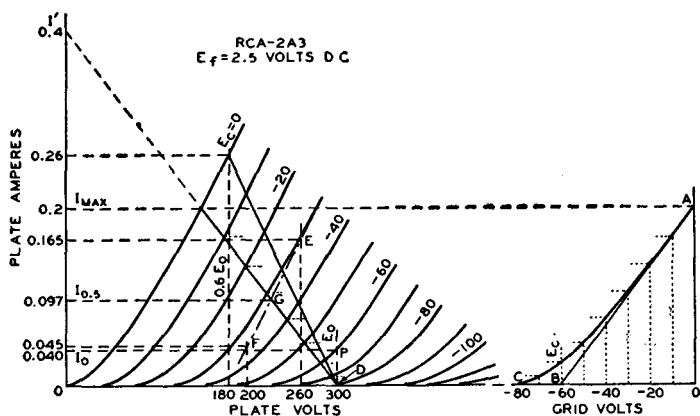

Fig. 25

Fig. 26

At this point, it is well to determine the plate dissipation and to compare it with the maximum rated value. From the average plate current formula ( $0.636 I_{max}$ ) mentioned previously, the maximum-signal average plate current is 0.166 ampere. The product of this current and the operating plate voltage is 49.8 watts, the average input to the two tubes. From this value, subtract the power output of 15.6 watts to obtain the total dissipation for both tubes which is 34.2 watts. Half of this value, 17 watts, is in excess of the 15-watt rating of the tube and it is necessary, therefore, to assume another and higher load resistance so that the plate-dissipation rating will not be exceeded.

It will be found that at an operating plate voltage of 300 volts the 2A3's require a plate-to-plate load resistance of 3000 ohms. From the formula for  $R_{pp}$ , the value of  $I'$  is found to be 0.4 ampere. The load line for the 3000-ohm load resistance is then represented by a straight line from the point  $I' = 0.4$  ampere on the plate-current ordinate to the point  $E_o = 300$  volts on the plate-voltage abscissa. At the intersection of the load line with the zero-bias curve, the peak plate current,  $I_{max}$ , can be read at 0.2 ampere. Then

$$\text{Power output} = (I_{max}/\sqrt{2})^2 R_{pp}/4 = (0.2/1.41)^2 \cdot 3000/4 = 15 \text{ watts}$$

Proceeding as in the first approximation, we find that the maximum-signal average plate current,  $0.636 I_{max}$ , is 0.127 ampere, and the maximum-signal average power input is 38.1 watts. This input minus the power output is  $38.1 - 15 = 23.1$  watts. This is the dissipation for two tubes; the value per tube is 11.6 watts, a value well within the rating of this tube type.

The operating bias and the zero-signal plate current may now be found by use of a curve which is derived from the plate family and the load line. Fig. 26 is a curve of instantaneous values of plate current and dc grid-bias voltages taken from Fig. 25. Values of grid bias are read from each of the grid-bias curves of Fig. 25

along the load line and are transferred to Fig. 26 to produce the curved line from A to C. A tangent to this curve, starting at A, is drawn to intersect the grid-voltage abscissa. The point of intersection, B, is the operating grid bias for fixed-bias operation. In the example, the bias is -60 volts. Refer back to the plate family at the operating conditions of plate volts = 300 and grid bias = -60 volts; the zero-signal plate current per tube is seen to be 0.04 ampere. This procedure locates the operating point for each tube at P. The plate current must be doubled, of course, to obtain the zero-signal plate current for both tubes. Under maximum-signal conditions, the signal voltage swings from zero-signal bias voltage to zero bias for each tube on alternate half cycles. Hence, in the example, the peak af signal voltage per tube is 60 volts, or the grid-to-grid value is 120 volts.

As in the case of the push-pull class A amplifier, the second-harmonic distortion in a class AB<sub>1</sub> amplifier using triodes is very small and is largely cancelled by virtue of the push-pull connection. Third-harmonic distortion, however, which may be larger than permissible, can be found by means of composite characteristic curves. A complete family of curves can be plotted, but for the present purpose only the one corresponding to a grid bias of one-half the peak grid-voltage swing is needed. In the example, the peak grid voltage per tube is 60 volts, and the half value is 30 volts. The composite curve, since it is nearly a straight line, can be constructed with only two points (see Fig. 25). These two points are obtained from deviations above and below the operating grid and plate voltages. In order to find the curve for a bias of -30 volts, we have assumed a deviation of 30 volts from the operating grid voltage of -60 volts. Next assume a deviation from the operating plate voltage of, say, 40 volts. Then at 300 - 40 = 260 volts, erect a vertical line to intersect the (-60) - (-30) = -30-volt bias curve and read the plate current at this intersection, which is 0.167 ampere; likewise, at the intersection of a vertical line at 300 + 40 = 340 volts and the (-60) + (-30) = -90-volt bias curve, read the plate current. In this example, the plate current is estimated to be 0.002 ampere. The difference of 0.165 ampere between these two currents determines the point E on the 300 - 40 = 260-volt vertical. Similarly, another point F on the same composite curve is found by assuming the same grid-bias deviation but a larger plate-voltage deviation, say, 100 volts. We now have points at 260 volts and 0.165 ampere (E), and at 200 volts and 0.045 ampere (F). A straight line through these points is the composite curve for a bias of -30 volts, shown as a long-short dash line in Fig. 25. At the intersection of the composite curve and the load line, G, the instantaneous composite plate current at the point of one-half the peak signal swing is determined. This current value, designated I<sub>0.5</sub> and the peak plate current, I<sub>max</sub>, are used in the following formula to find peak value of the third-harmonic component of the plate current.

$$I_{h_3} = (2I_{0.5} - I_{max})/3$$

In the example, where I<sub>0.5</sub> is 0.097 ampere and I<sub>max</sub> is 0.2 ampere, I<sub>h<sub>3</sub></sub> = (2 × 0.097 - 0.2)/3 = (0.194 - 0.2)/3 = -0.006/3 = -0.002 ampere. (The fact that I<sub>h<sub>3</sub></sub> is negative indicates that the phase relation of the fundamental (first-harmonic) and third-harmonic components of the plate current is such as to result in a slightly peaked wave form. I<sub>h<sub>3</sub></sub> is positive in some cases, indicating a flattening of the wave form.)

The peak value of the fundamental or first-harmonic component of the plate current is found by the following formula:

$$I_{h_1} = 2/3 (I_{max} + I_{0.5})$$

In the example, I<sub>h<sub>1</sub></sub> = 2/3 (0.2 + 0.097) = 0.198 ampere. Thus, the percentage of third-harmonic distortion is (I<sub>h<sub>3</sub></sub>/I<sub>h<sub>1</sub></sub>) 100 = (0.002/0.198)100 = 1% approx.

A class AB<sub>2</sub> amplifier employs two tubes connected in push-pull as in the case of class AB<sub>1</sub> amplifiers. It differs in that it is biased so that plate current flows for

somewhat more than half the electrical cycle but less than the full cycle, the peak signal voltage is greater than the dc bias voltage, grid current is drawn, and consequently, power is consumed in the grid circuit. These conditions permit high power output to be obtained without excessive plate dissipation.

The sum of the power used in the grid circuit and the losses in the input transformer is the total driving power required by the grid circuit. The driver stage should be capable of a power output considerably larger than this required power in order that distortion introduced in the grid circuit be kept low. In addition, the internal impedance of the driver stage as reflected into or as effective in the grid circuit of the power stage should always be as low as possible in order that distortion may be kept low. The input transformer used in a class AB<sub>2</sub> stage usually has a step-down ratio adjusted for this condition.

Load resistance, plate dissipation, power output, and distortion determinations are similar to those for class AB<sub>1</sub>. These quantities are interdependent with peak grid-voltage swing and driving power; a satisfactory set of operating conditions involves a series of approximations. The load resistance and signal swing are limited by the permissible grid current and power, and the distortion. If the load resistance is too high or the signal swing is excessive, the plate-dissipation rating will be exceeded, distortion will be high, and the driving power will be unnecessarily high.

A class B amplifier employs two tubes connected in push-pull, so biased that plate current is almost zero when no signal voltage is applied to the grids. Because of this low value of no-signal plate current, class B amplification has the same advantage as class AB<sub>2</sub>, i.e., large power output can be obtained without excessive plate dissipation. Class B operation differs from class AB<sub>2</sub> in that plate current is cut off for a larger portion of the negative grid swing, and the signal swing is usually larger than in class AB<sub>2</sub> operation.

Because tubes designed for use as class B amplifiers usually operate at zero or low bias, each grid is at a positive potential during all or most of the positive half-cycle of its signal swing and consequently draws considerable grid current. There is, therefore, a loss of power in the grid circuit. This condition imposes the same requirement in the driver stage as in a class AB<sub>2</sub> stage, that is, the driver should be capable of delivering considerably more power output than the power required for the class B grid circuit in order that distortion be low. Likewise, the interstage transformer between the driver and class B stage usually has a step-down turns ratio.

Determination of load resistance, plate dissipation, power output, and distortion is similar to that for a class AB<sub>2</sub> stage.

Power amplifier tubes designed for class A operation can be used in class AB<sub>2</sub> and class B service under suitable operating conditions. There are several tube types designed especially for class B service. The characteristic common to all of these types is a high amplification factor. With a high amplification factor, plate current is small even when the grid bias is zero. These tubes, therefore, can be operated in class B service at a bias of zero volts so that no bias supply is required. A number of class B amplifier tubes consist of two triode units mounted in one tube. The two units can be connected in push-pull so that only one tube is required for a class B stage. Examples of twin triodes used in class B service are the 6N7 and 1G6-GT.

The preceding text has discussed the use of tubes in the conventional grid-drive type of amplifier—that is, where the cathode is common to both the input and output circuits. Tubes may also be employed as amplifiers in circuit arrangements which utilize the grid or plate as the common terminal. Probably the most important of these amplifiers are the cathode-drive circuit, which is discussed below, and the cathode-follower circuit, which will be discussed later in connection with inverse feedback.

A typical **cathode drive** circuit is shown in Fig. 27. The load is placed in the plate circuit and the output voltage is taken off between the plate and ground as in the grid-drive method of operation. The grid is grounded, and the input voltage is applied across an appropriate impedance in the cathode circuit. The cathode-drive circuit is particularly useful for vhf and uhf applications, in which it is necessary to obtain the low-noise performance usually associated with a triode, but where a conventional grid-drive circuit would be unstable because of feedback through the grid-to-plate capacitance of the tube. In the cathode-drive circuit, the grounded grid serves as a capacitive shield between plate and cathode and permits stable operation at frequencies higher than those in which conventional circuits can be used. The input impedance of a cathode-drive circuit is approximately equal to  $1/g_m$  when the load resistance is small compared to the  $r_p$  of the tube. A certain amount of power is required, therefore, to drive such a circuit. However, in the type of service in which cathode-drive circuits are normally used, the advantages of the grounded-grid connection usually outweigh this disadvantage.

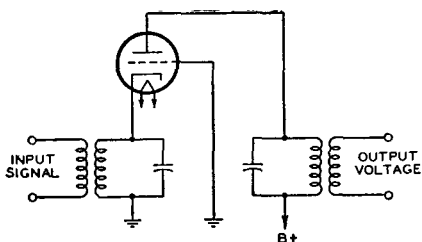

Fig. 27

An **inverse-feedback** circuit, sometimes called a **degenerative** circuit, is one in which a portion of the output voltage of a tube is applied to the input of the same or a preceding tube in opposite phase to the signal applied to the tube. Two important advantages of feedback are: (1) reduced distortion from each stage included in the feedback circuit and (2) reduction in the variations in gain due to changes in line voltage, possible differences between tubes of the same type, or variations in the values of circuit constants included in the feedback circuit.

Inverse feedback is used in audio amplifiers to reduce distortion in the output stage where the load impedance on the tube is a loudspeaker. Because the impedance of a loudspeaker is not constant for all audio frequencies, the load impedance on the output tube varies with frequency. When the output tube is a pentode or beam power tube having high plate resistance, this variation in plate load impedance can, if not corrected, produce considerable frequency distortion. Such frequency distortion can be reduced by means of inverse feedback. Inverse feedback circuits are of the **constant-voltage** type and the **constant-current** type.

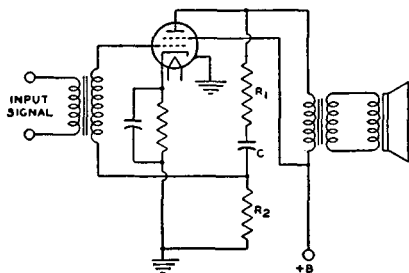

Fig. 28

The application of the **constant-voltage** type of inverse feedback to a power output stage using a single beam power tube is illustrated by Fig. 28. In this circuit,  $R_1$ ,  $R_2$ , and  $C$  are connected across the output of the 6L6 as a voltage divider. The secondary of the grid-input transformer is returned to a point on this voltage divider. Capacitor  $C$  blocks the dc plate voltage from the grid. However, a portion of the tube's af output voltage, approximately equal

to the output voltage multiplied by the fraction  $R_4/(R_1 + R_2)$ , is applied to the grid. This voltage lowers the source impedance of the circuit and a decrease in distortion results which is explained in the curves of Fig. 29.

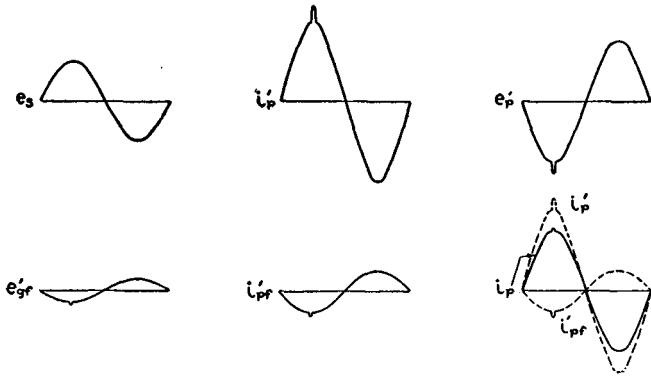

Fig. 29

Consider first the amplifier without the use of inverse feedback. Suppose that when a signal voltage  $e_s$  is applied to the grid the af plate current  $i'_p$  has an irregularity in its positive half-cycle. This irregularity represents a departure from the waveform of the input signal and is, therefore, distortion. For this plate-current waveform, the af plate voltage has a waveform shown by  $e'_p$ . The plate-voltage waveform is inverted compared to the plate-current waveform because a plate-current increase produces an increase in the drop across the plate load. The voltage at the plate is the difference between the drop across the load and the supply voltage; thus, when plate current goes up, plate voltage goes down; when plate current goes down, plate voltage goes up.

Now suppose that inverse feedback is applied to the amplifier. The voltage fed back to the grid has the same waveform and phase as the plate voltage, but is smaller in magnitude. Hence, with a plate voltage of waveform shown by  $e'_p$ , the feedback voltage appearing on the grid is as shown by  $e'_{gf}$ . This voltage applied to the grid produces a component of plate current  $i'_{pf}$ . It is evident that the irregularity in the waveform of this component of plate current would act to cancel the original irregularity and thus reduce distortion.

After inverse feedback has been applied, the relations are as shown in the curve for  $i_p$ . The dotted curve shown by  $i'_{pf}$  is the component of plate current due to the feedback voltage on the grid. The dotted curve shown by  $i'_p$  is the component of plate current due to the signal voltage on the grid. The algebraic sum of these two components gives the resultant plate current shown by the solid curve of  $i_p$ . Since  $i'_p$  is the plate current that would flow without inverse feedback, it can be seen that the application of inverse feedback has reduced the irregularity in the output current. In this manner inverse feedback acts to correct any component of plate current that does not correspond to the input signal voltage, and thus reduces distortion.

From the curve for  $i_p$ , it can be seen that, besides reducing distortion, inverse feedback also reduces the amplitude of the output current. Consequently, when inverse feedback is applied to an amplifier there is a decrease in gain or power sensitivity as well as a decrease in distortion. Hence, the application of inverse feedback to an amplifier requires that more driving voltage be applied to obtain full power output, but this output is obtained with less distortion.

Inverse feedback may also be applied to resistance-coupled stages as shown in Fig. 30. The circuit is conventional except that a feedback resistor,  $R_3$ , is connected between the plates of tubes  $T_1$  and  $T_2$ . The output signal voltage of  $T_1$  and a portion of the output signal voltage of  $T_2$  appears across  $R_2$ . Because the distortion generated in the plate circuit of  $T_2$  is applied to its grid out of phase with the input signal, the distortion in the output of  $T_2$  is comparatively low. With sufficient inverse feedback of the constant-voltage type in a power-output stage, it is not necessary to employ a network of resistance and capacitance such as that described on page 32 in the output circuit to reduce response at high audio frequencies. Inverse-feedback circuits can also be applied to push-pull class A and class  $AB_1$  amplifiers.

**Constant-current inverse feedback** is usually obtained by omitting the bypass capacitor across a cathode resistor. This method decreases the gain and the distortion but increases the source impedance of the circuit. Consequently, the output voltage rises at the resonant frequency of the loudspeaker and accentuates hangover effects.

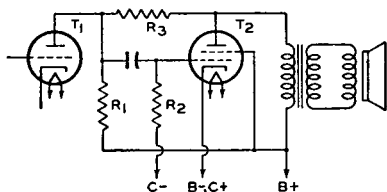

Fig. 30

Inverse feedback is not generally applied to a triode power amplifier, such as the 2A3, because the variation in speaker impedance with frequency does not produce much distortion in a triode stage having low plate resistance. It is sometimes applied in a pentode stage but is not always convenient. As has been shown, when inverse feedback is used in an amplifier, the driving voltage must be increased in order to give full power output. When inverse feedback is used with a pentode, the total driving voltage required for full power output may be inconveniently large, although still less than that required for a triode. Because a beam power tube gives full power output on a comparatively small driving voltage, inverse feedback is especially applicable to beam power tubes. By means of inverse feedback, the high efficiency and high power output of beam power tubes can be combined with freedom from the effects of varying speaker impedance.

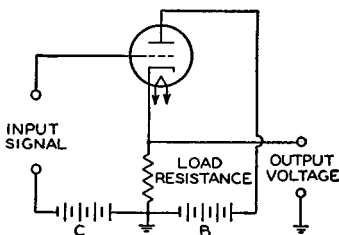

Fig. 31

Another important application of inverse feedback is in the **cathode-follower** circuit, an example of which is given in Fig. 31. In this application, the load has been transferred from the plate circuit to the cathode circuit of the tube. The input voltage is applied between the grid and ground and the output is taken off between the cathode and ground. The voltage amplification of this circuit is always less than unity and may be expressed by the following convenient formulas.

*For a triode:*

$$\text{Voltage amplification} = \frac{\text{amplification factor} \times \text{load resistance}}{\text{plate resistance} + \text{load resistance} \times (\text{amplification factor} + 1)}$$

*For a pentode:*

$$\text{Voltage amplification} = \frac{\text{transconductance} \times \text{load resistance}}{1 + (\text{transconductance} \times \text{load resistance})}$$

Resistance values are in ohms; transconductance values are in mhos.

The use of the cathode follower permits the design of circuits which have high input resistance and high output voltage. The output impedance is quite low and very low distortion may be obtained. Cathode-follower circuits may be used for power amplifiers or as impedance transformers designed either to match a transmission line or to produce a relatively high output voltage at a low impedance level. In a power amplifier which is transformer coupled to the load, the same output power can be obtained from the tube as would be obtained in a conventional grid-drive type of amplifier. The output impedance is very low and provides excellent damping to the load, with the result that very low distortion can be obtained. The peak-to-peak signal voltage, however, approaches  $1\frac{1}{2}$  times the plate supply voltage if maximum power output is required from the tube. Some problems may be encountered, therefore, in the design of an adequate driver stage for a cathode-follower output system.

When a cathode-follower circuit is used as an impedance transformer, the load is usually a simple resistance in the cathode circuit of the tube. With relatively low values of cathode resistor, the circuit may be designed to supply significant amounts of power and to match the impedance of the device to a transmission line. With somewhat higher values of cathode resistor, the circuit may be used to lower the output impedance sufficiently to permit the transmission of audio signals along a line in which appreciable capacitance is present.

The cathode follower may also be used as an isolation device to provide extremely high input resistance and low input capacitance as might be required in the probe of an oscilloscope or vacuum-tube voltmeter. Such circuits can be designed to provide effective impedance transformation with no significant loss of voltage.

Selection of a suitable tube and its operating conditions for use in a cathode-follower circuit having a specified output impedance can be made, in most practical cases, by the use of the following formula to determine the required tube transconductance.

$$\text{Required transconductance (micromhos)} = \frac{1,000,000}{\text{output impedance (ohms)}}$$

Once the required transconductance is obtained, a suitable tube and its operating conditions may be determined from the TECHNICAL DATA SECTION. The conversion curves given in Fig. 24 may be used for calculating operating conditions for values of transconductance not included in the tabulated data. After the operating conditions have been determined, the value of the required cathode load resistance may be calculated from the following formula.

*For triode:*

$$\text{Cathode load resistance} = \frac{\text{output impedance} \times \text{plate resistance}}{\text{plate resistance} - \text{output impedance} (1 + \text{amplification factor})}$$

*For pentode:*

$$\text{Cathode load resistance} = \frac{\text{output impedance}}{1 - (\text{transconductance} \times \text{output impedance})}$$

Resistance and impedance values are in ohms; transconductance values are in mhos.



If the value of the cathode load resistance calculated to give the required output impedance does not give the required operating bias, the basic cathode-follower circuit can be modified in a number of ways. Two of the more common modifications are given in Figs. 32 and 33. In Fig. 32 the bias is increased by adding a bypassed resistance between the cathode and the unbypassed load resistance and returning the grid to the low end of the load resistance. In Fig. 33 the bias is reduced by adding a bypassed resistance between the cathode and the unbypassed load resistance but, in this case, the grid is returned to the junction of the two cathode resistors so that the bias voltage is only the dc voltage drop across the added resistance. The size of the bypass capacitor should be large enough so that

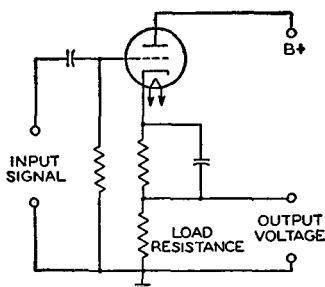

Fig. 32

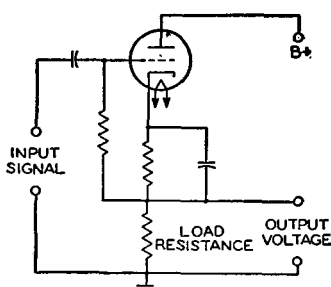

Fig. 33

it presents negligible reactance at the lowest frequency to be handled. In both cases the B-supply should be increased to make up for the voltage taken for biasing. Example: Select a suitable tube and determine the operating conditions and circuit components for a cathode-follower circuit having an output impedance that will match a 500-ohm transmission line. Procedure: First, determine the approximate transconductance required.

$$\text{Required transconductance} = \frac{1,000,000}{500} = 2000 \text{ micromhos}$$

A survey of the tubes that have a transconductance in this order of magnitude shows that type 12AX7 is among the tubes to be considered. Referring to the characteristics given in the technical data section for one triode unit of high- $\mu$  twin triode 12AX7, we find that for a plate voltage of 250 volts and a bias of -2 volts, the transconductance is 1600 micromhos, the plate resistance is 62500 ohms, the amplification factor is 100, and the plate current is 0.0012 ampere. When these values are used in the expression for determining the cathode load resistance, we obtain

$$\text{Cathode load resistance} = \frac{500 \times 62500}{62500 - 500(100 + 1)} = 2600 \text{ ohms}$$

The voltage across this resistor for a plate current of 0.0012 ampere is  $2600 \times 0.0012 = 3.12$  volts. Because the required bias voltage is only -2 volts, the circuit arrangement given in Fig. 31 is employed. The bias is furnished by a resistance that will have a voltage drop of 2 volts when it carries a current of 0.0012 ampere. The required bias resistance, therefore, is  $2/0.0012 = 1670$  ohms. If 60 cycles per second is the lowest frequency to be passed, 20 microfarads is a suitable value for the bypass capacitor. The B-supply, of course, is increased by the voltage drop across the cathode resistance which, in this example, is approximately 5 volts. The B-supply, therefore, is  $250 + 5 = 255$  volts.

Since it is desirable to eliminate, if possible, the bias resistor and bypass capacitor, it is worthwhile to try other tubes and other operating conditions to obtain a value of cathode load resistance which will also provide the required bias.

If the triode section of twin diode—high-mu triode 6AT6 is operated under the conditions given in the technical data section with a plate voltage of 100 volts and a bias of -1 volt, it will have an amplification factor of 70, a plate resistance of 54000 ohms, a transconductance of 1300 micromhos, and a plate current of 0.0008 ampere.

Then,

$$\text{Cathode load resistance} = \frac{500 \times 54000}{54000 - 500(70 + 1)} = 1460 \text{ ohms}$$

The bias voltage obtained across this resistance is  $1460 \times 0.0008 = 1.17$  volts. Since this value is for all practical purposes close enough to the required bias, no additional bias resistance will be required and the grid may be returned directly to ground. There is no need to adjust the B-supply voltage to make up for the drop in the cathode resistor. The voltage amplification for the cathode-follower circuit utilizing the triode section of type 6AT6 is

$$\text{Voltage amplification} = \frac{70 \times 1460}{54000 - 1460(70 + 1)} = 0.65$$

For applications in which the cathode follower is used to isolate two circuits—for example, when it is used between a circuit being tested and the input stage of an oscilloscope or a vacuum-tube voltmeter—voltage output and not impedance matching is the primary consideration. In such applications it is desirable to use a relatively high value of cathode load resistance, such as 50,000 ohms, in order to get the maximum voltage output. In order to obtain proper bias, a circuit such as that of Fig. 33 should be used. With a high value of cathode resistance, the voltage amplification will approximate unity.

A corrective filter can be used to improve the frequency characteristic of an output stage using a beam power tube or a pentode when inverse feedback is not applicable. The filter consists of a resistor and a capacitor connected in series across the primary of the output transformer. Connected in this way, the filter is in parallel with the plate load impedance reflected from the voice-coil by the output transformer. The magnitude of this reflected impedance increases with increasing frequency in the middle and upper audio range. The impedance of the filter, however, decreases with increasing frequency. It follows that by use of the proper values for the resistance and the capacitance in the filter, the effective load impedance on the output tubes can be made practically constant for all frequencies in the middle and upper audio range. The result is an improvement in the frequency characteristic of the output stage.

The resistance to be used in the filter for a push-pull stage is 1.3 times the recommended plate-to-plate load resistance; or, for a single-tube stage, is 1.3 times the recommended plate load resistance. The capacitance in the filter should have a value such that the voltage gain of the output stage at a frequency of 1000 cycles or higher is equal to the voltage gain at 400 cycles. A method of determining the proper value of capacitance for the filter is to make two measurements of the output voltage across the primary of the output transformer: first, when a 400-cycle signal is applied to the input, and second, when a 1000-cycle signal of the same voltage as the 400-cycle signal is applied to the input. The correct value of capacitance is the one which gives equal output voltages for the two signal inputs. In practice, this value is usually found to be in the order of 0.05 microfarad.

A volume expander can be used in a phonograph amplifier to make more natural the reproduction of music which has a very large volume range. For instance, in the music of a symphony orchestra, the sound intensity of the loud passages is very much higher than that of the soft passages. When this music is recorded, it is not feasible to make the ratio of maximum amplitude to minimum amplitude as large on the record as it is in the original music. The recording process

is therefore monitored so that the volume range of the original is compressed on the record. To compensate for this compression, a volume-expander amplifier has a variable gain which is greater for a high-amplitude signal than for a low-amplitude signal. The volume expander, therefore, amplifies loud passages more than soft passages and thus can restore to the music reproduced from the record the volume range of the original.

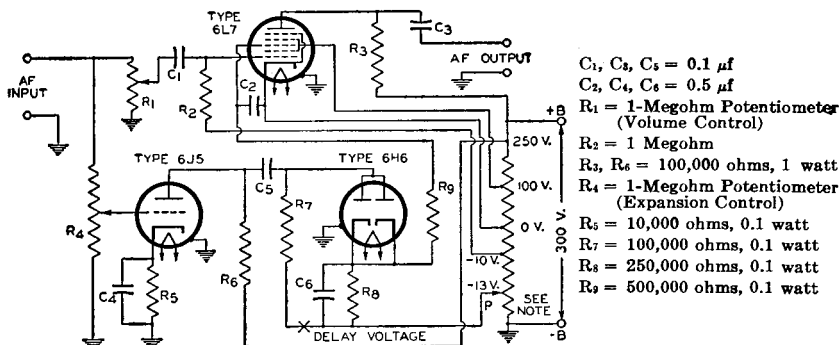

Fig. 34

- $C_1, C_2, C_5 = 0.1 \mu\text{f}$
- $C_3, C_4, C_6 = 0.5 \mu\text{f}$
- $R_1 = 1\text{-Megohm Potentiometer (Volume Control)}$
- $R_2 = 1 \text{ Megohm}$
- $R_3, R_6 = 100,000 \text{ ohms, } 1 \text{ watt}$
- $R_4 = 1\text{-Megohm Potentiometer (Expansion Control)}$
- $R_5 = 10,000 \text{ ohms, } 0.1 \text{ watt}$
- $R_7 = 100,000 \text{ ohms, } 0.1 \text{ watt}$
- $R_8 = 250,000 \text{ ohms, } 0.1 \text{ watt}$
- $R_9 = 500,000 \text{ ohms, } 0.1 \text{ watt}$

A volume expander circuit is shown in Fig. 34. In this circuit, the gain of the 6L7 as an audio amplifier can be varied by changing the bias on grid No. 3. When the bias on grid No. 3 is made less negative, the gain of the 6L7 increases. The signal to be amplified is applied to grid No. 1 of the 6L7 and is amplified by the 6L7. The signal is also applied to the grid of the 6J5, is amplified by the 6J5, and is rectified by the 6H6. The rectified voltage developed across  $R_6$ , the load resistor of the 6H6, is applied as a positive bias voltage to grid No. 3 of the 6L7. Then, when the amplitude of the signal input increases, the voltage across  $R_6$  increases, and the bias on grid No. 3 of the 6L7 is made less negative. Because this reduction in bias increases the gain of the 6L7, the gain of the amplifier increases with increase in signal amplitude and thus produces volume expansion of the signal. The voltage gain of the expander varies from 5 to 20.

Grid No. 1 of the 6L7 is a variable- $\mu$  grid and, therefore, will produce distortion if the input signal voltage is too large. For that reason, the signal input to the 6L7 should not exceed a peak value of 1 volt. The no-signal bias voltage on grid No. 3 is controlled by adjustment of contact P. This contact should be adjusted initially to give a no-signal plate current of 0.15 milliamperes in the 6L7. No further adjustment of contact P is required if the same 6L7 is always used. If it is desired to delay volume expansion until the signal input reaches a certain amplitude, the delay voltage can be inserted as a negative bias on the 6H6 plates at the point marked X in the diagram. All terminal points on the power-supply voltage divider should be adequately bypassed.

A phase inverter is a circuit used to provide resistance coupling between the output of a single-tube stage and the input of a push-pull stage. The necessity for a phase inverter arises because the signal-voltage inputs to the grids of a push-pull stage must be 180 degrees out of phase and approximately equal in amplitude with respect to each other. Thus, when the signal voltage input to a push-pull stage swings the grid of one tube in a positive direction, it should swing the grid of the other tube in a negative direction by a similar amount. With transformer coupling between stages, the out-of-phase input voltage to the push-pull stage is supplied by means of the center-tapped secondary. With resistance coupling, the out-of-phase input voltage is obtained by means of the inverter action of a tube.

Fig. 35 shows a push-pull power amplifier, resistance-coupled by means of a phase-inverter circuit to a single-stage triode  $T_1$ . Phase inversion in this circuit is provided by triode  $T_2$ . The output voltage of  $T_1$  is applied to the grid of triode  $T_3$ . A portion of the output voltage of  $T_1$  is also applied through the resistors  $R_3$  and  $R_5$  to the grid of  $T_2$ . The output voltage of  $T_2$  is applied to the grid of triode  $T_4$ . When the output voltage of  $T_1$  swings in the positive direction, the plate current of  $T_2$  increases. This action increases the voltage drop across the plate resistor  $R_2$  and swings the plate of  $T_2$  in the negative direction. Thus, when the output voltage of  $T_1$  swings positive, the output voltage of  $T_2$  swings negative and is, therefore,  $180^\circ$  out of phase with the output voltage of  $T_1$ . In order to obtain equal voltages at  $E_a$  and  $E_b$ ,  $(R_3 + R_5)/R_5$  should equal the voltage gain of  $T_2$ . Under the conditions where a twin-type tube or two tubes having the same characteristics are used at  $T_1$  and  $T_2$ ,  $R_4$  should be equal to the sum of  $R_3$  and  $R_5$ . The ratio of  $R_3 + R_5$  to  $R_5$  should be the same as the voltage gain ratio of  $T_2$  in order to apply the correct value of signal voltage to  $T_2$ . The value of  $R_5$  is, therefore, equal to  $R_4$  divided by the voltage gain of  $T_2$ ;  $R_3$  is equal to  $R_4$  minus  $R_5$ . Values of  $R_1$ ,  $R_2$ ,  $R_3$  plus  $R_5$ , and  $R_4$  may be taken from the chart in the RESISTANCE-COUPLED AMPLIFIER SECTION. In the practical application of this circuit, it is convenient to use a twin-triode tube combining  $T_1$  and  $T_2$ .

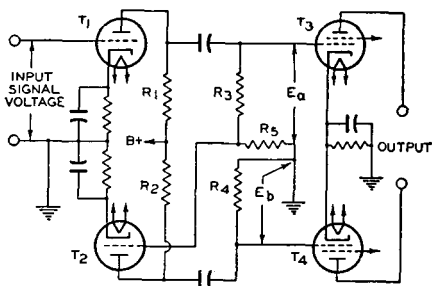

Fig. 35

An amplifier may also be used as a **limiter**. One use of a limiter is in receivers designed for the reception of frequency-modulated signals. The limiter in FM receivers has the function of eliminating amplitude variations from the input to the detector. Because in an FM system amplitude variations are primarily the result of noise disturbances, the use of a limiter prevents such disturbances from being reproduced in the audio output. The limiter usually follows the last if stage so that it can minimize the effects of disturbances coming in on the rf carrier and those produced locally.

The limiter is essentially an if voltage amplifier designed for saturated operation. Saturated operation means that an increase in signal voltage above a certain value produces very little increase in plate current. A signal voltage which is never less than sufficient to cause saturation of the limiter, even on weak signals, is supplied to the limiter input by the preceding stages. Any change in amplitude, therefore, such as might be produced by noise voltage fluctuation, is not reproduced in the limiter output. The limiting action, of course, does not interfere with the reproduction of frequency variations. Plate-current saturation of the limiter may be obtained by the use of grid-No.1-resistor-and-capacitor bias with plate and grid-No.2 voltages which are low compared with customary if-amplifier operating conditions. As a result of these design features, the limiter is able to maintain its output voltage at a constant amplitude over a wide range of input-signal voltage variations. The output of the limiter is frequency-modulated if voltage, the mean frequency of which is that of the if amplifier. This voltage is impressed on the input of the detector.

The reception of FM signals without serious distortion requires that the response of the receiver be such that satisfactory amplification of the signal is provided over the entire range of frequency deviation from the mean frequency. Since the frequency at any instant depends on the modulation at that instant, it follows

The reception of FM signals without serious distortion requires that the response of the receiver be such that satisfactory amplification of the signal is provided over the entire range of frequency deviation from the mean frequency. Since the frequency at any instant depends on the modulation at that instant, it follows

that excessive attenuation toward the edges of the band, in the rf or if stages, will cause distortion. In a high-fidelity receiver, therefore, the amplifiers must be capable of amplifying, for the maximum permissible frequency deviation of 75 kilocycles, a band 150 kilocycles wide. Suitable tubes for this purpose are the 6BA6 and 6BJ6.

### RECTIFICATION

The rectifying action of a diode finds an important application in supplying a receiver with dc power from an ac line. A typical arrangement for this application includes a rectifier tube, a filter, and a voltage divider. The rectifying action of the tube is explained briefly under *Diodes*, in the ELECTRONS, ELECTRODES, AND ELECTRON TUBE SECTION. The function of a filter is to smooth out the ripple of the tube output, as indicated in Fig. 36, and to increase rectifier efficiency. The action of the filter is explained in ELECTRON TUBE INSTALLATION SECTION under *Filters*. The voltage divider is used to cut down the output voltage to the values required by the plates and the other electrodes of the tubes in the receiver.

A half-wave rectifier and a full-wave rectifier circuit are shown in Fig. 37. In the half-wave circuit, current flows through the rectifier tube to the filter on every other half-cycle of the ac input voltage when the plate is positive with respect to the cathode. In the full-wave circuit, current flows to the filter on every half-cycle, through plate No. 1 on one half-cycle when plate No. 1 is positive with respect to the cathode, and through plate No. 2 on the next half-cycle when plate No. 2 is positive with respect to the cathode. Because the current flow to the filter is more uniform in the full-wave circuit than in the half-wave circuit, the output of the full-wave circuit requires less filtering. Rectifier operating information and circuits are given under each rectifier tube type and in the CIRCUIT SECTION, respectively.

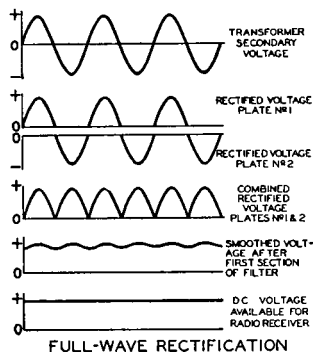

Fig. 36

the plates of each tube are connected together and each tube acts as a half-wave rectifier. The allowable voltage and load conditions per tube are the same as for full-wave service but the total load-handling capability of the complete rectifier

**Parallel operation** of rectifier tubes furnishes an output current greater than that obtainable with the use of one tube. For example, when two full-wave rectifier tubes are connected in parallel,

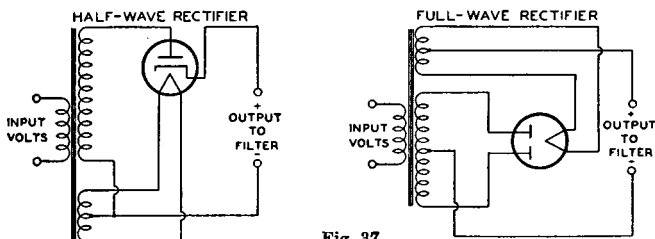

Fig. 37

is approximately doubled. When mercury-vapor rectifier tubes are connected in parallel, a stabilizing resistor of 50 to 100 ohms should be connected in series with each plate lead in order that each tube will carry an equal share of the load. The value of the resistor to be used will depend on the amount of plate current that passes through the rectifier. Low plate current requires a high value; high plate current, a low value. When the plates of mercury-vapor rectifier tubes are connected

in parallel, the corresponding filament leads should be similarly connected. Otherwise, the tube drops will be considerably unbalanced and larger stabilizing resistors will be required. Two or more vacuum rectifier tubes can also be connected in parallel to give correspondingly higher output current and, as a result of paralleling their internal resistances, give somewhat increased voltage output. With vacuum types, stabilizing resistors may or may not be necessary depending on the tube type and the circuit.

A voltage-doubler circuit of simple form is shown in Fig. 38. The circuit derives its name from the fact that its dc voltage output can be as high as twice the peak value of ac input. Basically, a voltage doubler is a rectifier circuit arranged so that the output voltages of two half-wave rectifiers are in series.

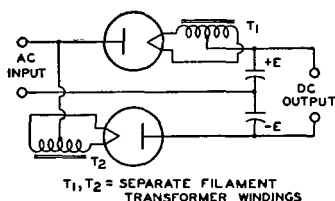

Fig. 38

the ac input, when the upper side of the line is negative with respect to the lower side, the lower diode passes current so that a negative voltage builds up across the capacitor. So long as no current is drawn at the output terminals from the capacitor, each capacitor can charge up to a voltage of magnitude  $E$ , the peak value of the ac input. It can be seen from the diagram that with a voltage of  $+E$  on one capacitor and  $-E$  on the other, the total voltage across the capacitors is  $2E$ . Thus the voltage doubler supplies a no-load dc output voltage twice as large as the peak ac input voltage. When current is drawn at the output terminals by the load, the output voltage drops below  $2E$  by an amount that depends on the magnitude of the load current and the capacitance of the capacitors. The arrangement shown in Fig. 36 is called a full-wave voltage doubler because each rectifier passes current to the load on each half of the ac input cycle.

Two rectifier types especially designed for use as voltage doublers are the 25Z6 and 117Z6-GT. These tubes combine two separate diodes in one tube. As voltage doublers, the tubes are used in "transformerless" receivers. In these receivers, the heaters of all tubes in the set are connected in series with a voltage-dropping resistor across the line. The connections for the heater supply and the voltage-doubling circuit are shown in Figs. 39 and 40.

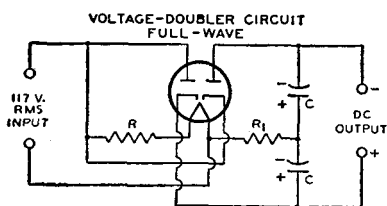

Fig. 39

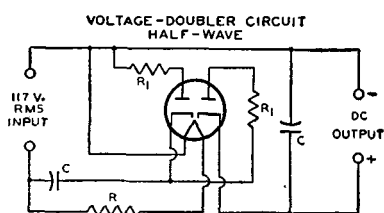

Fig. 40

$R$  = HEATERS OF OTHER TUBES IN SERIES  
WITH VOLTAGE-DROPPING RESISTOR  
 $R_1$  = PROTECTIVE RESISTOR

With the full-wave voltage-doubler circuit in Fig. 39, it will be noted that the dc load circuit can not be connected to ground or to one side of the ac supply line. This circuit presents certain disadvantages when the heaters of all the tubes in the

set are connected in series with a resistance across the ac line. Such a circuit arrangement may cause hum because of the high ac potential between the heaters and cathodes of the tubes. The circuit in Fig. 40 overcomes this difficulty by making one side of the ac line common with the negative side of the dc load circuit. In this circuit, one half of the tube is used to charge a capacitor which, on the following half cycle, discharges in series with the line voltage through the other half of the tube. This circuit is called a half-wave voltage doubler because rectified current flows to the load only on alternate halves of the ac input cycle. The voltage regulation of this arrangement is somewhat poorer than that of the full-wave voltage doubler.

### DETECTION

When speech or music is transmitted from a radio station, the station radiates a radio-frequency (rf) wave which is of either of two general types. In one type, the wave is said to be amplitude modulated when its frequency remains constant and the amplitude is varied. In the other type, the wave is said to be frequency modulated when its amplitude remains essentially constant but its frequency is varied. In either case, the varying component is modulated in accordance with the audio frequencies (af) of the speech or music being transmitted.

The function of the receiver is to reproduce the original af modulating wave from the modulated rf wave. The receiver stage in which this function is performed is called the demodulator or detector stage.

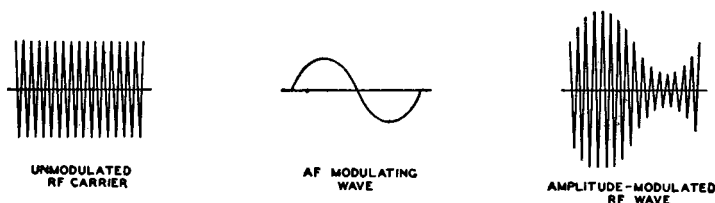

Fig. 41

The effect of **amplitude modulation** on the waveform of the rf wave is shown in Fig. 41. There are three different basic circuits used for the detection of amplitude-modulated waves: the diode detector, the grid-bias detector, and the grid-resistor detector. These circuits are alike in that they eliminate, either partially or completely, alternate half-cycles of the rf wave. With alternate half-cycles removed, the audio variations of the other half-cycles can be amplified to drive headphones or a loudspeaker.

A **diode-detector** circuit is shown in Fig. 42. The action of this circuit when a modulated rf wave is applied is illustrated by Fig. 43. The rf voltage applied to

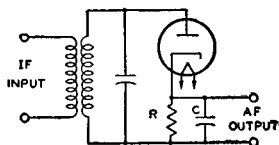

Fig. 42

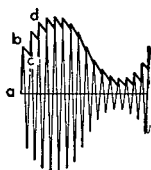

Fig. 43

the circuit is shown in light line; the output voltage across capacitor C is shown in heavy line. Between points (a) and (b) on the first positive half-cycle of the applied rf voltage, capacitor C charges up to the peak value of the rf voltage.

Then as the applied rf voltage falls away from its peak value, the capacitor holds the cathode at a potential more positive than the voltage applied to the anode. The capacitor thus temporarily cuts off current through the diode. While the diode current is cut off, the capacitor discharges from (b) to (c) through the diode load resistor R. When the rf voltage on the anode rises high enough to exceed the potential at which the capacitor holds the cathode, current flows again and the capacitor charges up to the peak value of the second positive half-cycle at (d). In this way, the voltage across the capacitor follows the peak value of the applied rf voltage and reproduces the af modulation. The curve for voltage across the capacitor, as drawn in Fig. 43, is somewhat jagged. However, this jaggedness, which represents an rf component in the voltage across the capacitor, is exaggerated in the drawing. In an actual circuit the rf component of the voltage across the capacitor is negligible. Hence, when the voltage across the capacitor is amplified, the output of the amplifier reproduces the speech or music originating at the transmitting station.

Another way to describe the action of a diode detector is to consider the circuit as a half-wave rectifier. When the rf signal on the plate swings positive, the tube conducts and the rectified current flows through the load resistance R. Because the dc output voltage of a rectifier depends on the voltage of the ac input, the dc voltage across C varies in accordance with the amplitude of the rf carrier and thus reproduces the af signal. Capacitor C should be large enough to smooth out rf or if variations but should not be so large as to affect the audio variations. Two diodes can be connected in a circuit similar to a full-wave rectifier to give full-wave detection. However, in practice, the advantages of this connection generally do not justify the extra circuit complication.

The diode method of detection produces less distortion than other methods because the dynamic characteristics of a diode can be made more linear than those of other detectors. The disadvantages of a diode are that it does not amplify the signal, and that it draws current from the input circuit and therefore reduces the selectivity of the input circuit. However, because the diode method of detection produces less distortion and because it permits the use of simple avc circuits without the necessity for an additional voltage supply, the diode method of detection is most widely used in broadcast receivers.

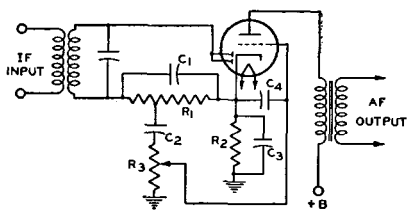

Fig. 44

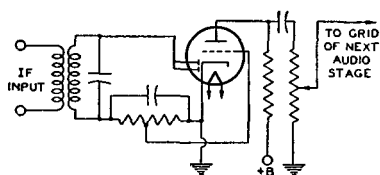

Fig. 45

A typical diode-detector circuit using a twin-diode triode tube is shown in Fig. 44. Both diodes are connected together.  $R_1$  is the diode load resistor. A portion of the af voltage developed across this resistor is applied to the triode grid through the volume control  $R_3$ . In a typical circuit, resistor  $R_1$  may be tapped so that five-sixths of the total af voltage across  $R_1$  is applied to the volume control. This tapped connection reduces the af voltage output of the detector circuit slightly but it reduces audio distortion and improves the rf filtering. DC bias for the triode section is provided by the cathode-bias resistor  $R_2$  and the audio bypass capacitor  $C_3$ . The function of capacitor  $C_2$  is to block the dc bias of the cathode from the grid. The function of capacitor  $C_4$  is to bypass any rf voltage on the grid to cathode. A twin-diode pentode may also be used in this circuit. With a pentode, the af output should be resistance-coupled rather than transformer-coupled.



Another diode-detector circuit, called a diode-biased circuit, is shown in Fig. 45. In this circuit, the triode grid is connected directly to a tap on the diode load resistor. When an rf signal voltage is applied to the diode, the dc voltage at the tap supplies bias to the triode grid. When the rf signal is modulated, the af voltage at the tap is applied to the grid and is amplified by the triode. The advantage of this circuit over the self-biased arrangement shown in Fig. 44 is that the diode-biased circuit does not employ a capacitor between the grid and the diode load resistor, and consequently does not produce as much distortion of a signal having a high percentage of modulation.

However, there are restrictions on the use of the diode-biased circuit. Because the bias voltage on the triode depends on the average amplitude of the rf voltage applied to the diode, the average amplitude of the voltage applied to the diode should be constant for all values of signal strength at the antenna. Otherwise there will be different values of bias on the triode grid for different signal strengths and the triode will produce distortion. Because there is no bias applied to the diode-biased triode when no rf voltage is applied to the diode, sufficient resistance should be included in the plate circuit of the triode to limit its zero-bias plate current to a safe value. These restrictions mean, in practice, that the receiver should have a separate-channel avc system. With such an avc system, the average amplitude of the signal voltage applied to the diode can be held within very close limits for all values of signal strength at the antenna. The tube used in a diode-biased circuit should be one which operates at a fairly large value of bias voltage. The variations in bias voltage are then a small percentage of the total bias and hence produce small distortion. Tubes taking a fairly large bias voltage are types such as the 6BF6 or 6ST7 having a medium- $\mu$  triode. Tube types having a high- $\mu$  triode or a pentode should not be used in a diode-biased circuit.

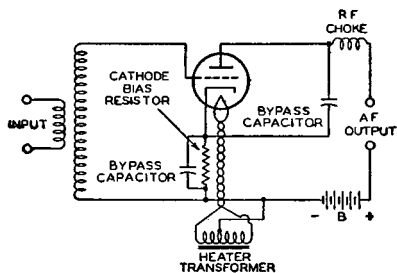

Fig. 46

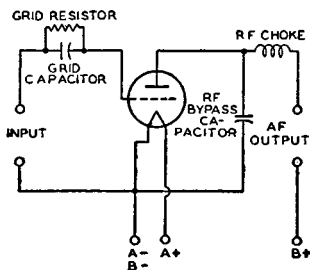

Fig. 47

A grid-bias detector circuit is shown in Fig. 46. In this circuit, the grid is biased almost to cutoff, i.e., operated so that the plate current with zero signal is practically zero. The bias voltage can be obtained from a cathode-bias resistor, a C-battery, or a bleeder tap. Because of the high negative bias, only the positive half-cycles of the rf signal are amplified by the tube. The signal is, therefore, detected in the plate circuit. The advantages of this method of detection are that it amplifies the signal, besides detecting it, and that it does not draw current from the input circuit and therefore does not lower the selectivity of the input circuit.

The grid-resistor-and-capacitor method, illustrated by Fig. 47, is somewhat more sensitive than the grid-bias method and gives its best results on weak signals. In this circuit, there is no negative dc bias voltage applied to the grid. Hence, on the positive half-cycles of the rf signal, current flows from grid to cathode. The grid and cathode thus act as a diode detector, with the grid resistor as the diode load resistor and the grid capacitor as the rf bypass capacitor. The voltage across the capacitor then reproduces the af modulation in the same manner as has been explained for the diode detector. This voltage appears between the grid and cathode and is therefore amplified in the plate circuit. The output voltage thus reproduces the original af signal.

In this detector circuit, the use of a high-resistance grid resistor increases selectivity and sensitivity. However, improved af response and stability are obtained with lower values of grid-circuit resistance. This detector circuit amplifies the signal, but draws current from the input circuit and therefore lowers the selectivity of the input circuit.

The effect of **frequency modulation** on the waveform of the rf wave is shown in Fig. 48. In this type of transmission, the frequency of the rf wave deviates from

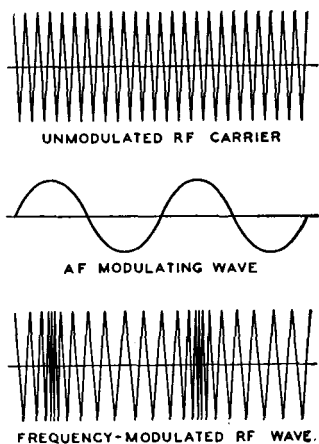

Fig. 48

a mean value, at an af rate depending on the modulation, by an amount that is determined in the transmitter and is proportional to the amplitude of the af modulation signal. For this type of modulation, a detector is required to discriminate between deviations above and below the mean frequency and to translate those deviations into a voltage whose amplitude varies at audio frequencies. Since the deviations occur at an audio frequency, the process is one of demodulation, and the degree of frequency deviation determines the amplitude of the demodulated (af) voltage.

A simple circuit for converting frequency variations to amplitude variations is a circuit which is tuned so that the mean radio frequency is on one slope of its resonance characteristic, as at A of Fig. 49. With modulation, the frequency swings between B and C, and the voltage developed across the circuit varies at the modulating rate. In order that no distortion will be introduced in this circuit, the frequency swing must be restricted to the portion of the slope which is effectively straight. Since this portion is very short, the voltage developed is low. Because of these limitations, this circuit is not commonly used but it serves to illustrate the principle.

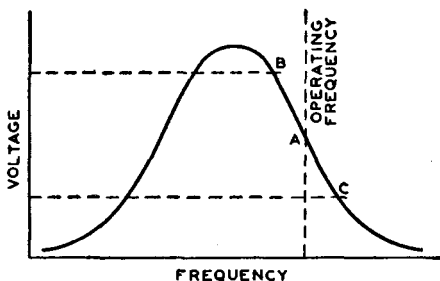

Fig. 49

The faults of the simple circuit are overcome in a push-pull arrangement, sometimes called a **discriminator circuit**, such as that shown in Fig. 50. Because of the phase relationships between the primary and each half of the secondary of the input transformer (each half of the secondary is connected in series with the primary through capacitor  $C_2$ ), the rf voltages applied to the diodes become unequal as the rf signal swings from the resonant frequency in each direction. Since the

swing occurs at audio frequencies (determined by the af modulation), the voltage developed across the diode load resistors,  $R_1$  and  $R_2$  connected in series, varies at

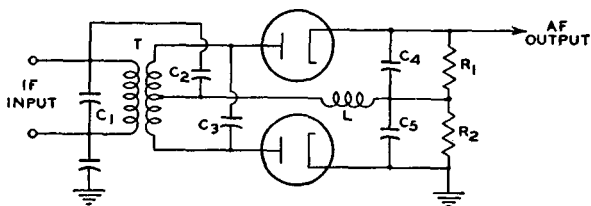

Fig. 50

audio frequencies. The output voltage depends on the difference in amplitude of the voltages developed across  $R_1$  and  $R_2$ . These voltages are equal and of opposite sign when the rf carrier is not modulated and the output is, therefore, zero. When modulation is applied, the output voltage varies as indicated in Fig. 51.

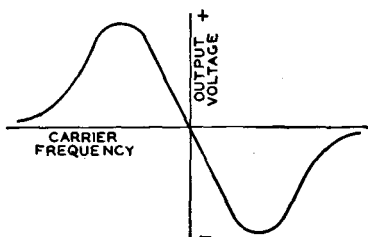

Fig. 51

Because this type of FM detector is sensitive to amplitude variations in the rf carrier, a limiter stage is frequently used to remove most of the amplitude modulation from the carrier. (See Limiters under Amplification.)

Another form of detector for frequency-modulated waves is called a **ratio detector**. This FM detector, unlike the previous one which responds to a difference in voltage, responds only to changes in the ratio of the voltage across the two diodes (Fig. 52) and is, therefore, insensitive to changes in the differences in the voltages due to amplitude modulation of the rf carrier.

The basic ratio detector is given in Fig. 52. The plate load for the final intermediate-frequency-amplifier stage is the parallel resonant circuit consisting of  $C_1$  and the primary transformer T. The tuning and coupling of the transformer is practically the same as in the previous circuit and, therefore, the rf voltages applied to the diodes depend upon how much the rf signal swings from the resonant frequency in each direction. At this point the similarity ends.

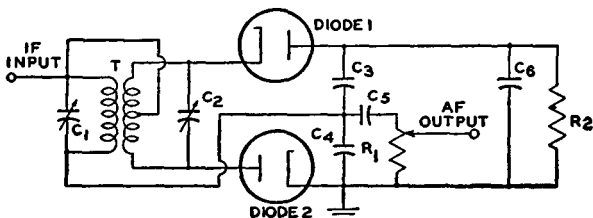

Fig. 52

Diode 1,  $R_2$ , and diode 2 complete a series circuit fed by the secondary of the transformer T. The two diodes are connected in series so that they conduct on the same rf half-cycle. The rectified current through  $R_2$  causes a negative voltage to appear at the plate of diode 1. Because  $C_6$  is large, this negative voltage at the plate of diode 1 remains constant even at the lowest audio frequencies to be reproduced. The rectified voltage across  $C_3$  is proportional to the voltage across diode 1, and the rectified voltage across  $C_4$  is proportional to the voltage across diode 2. Since the voltages across the two diodes differ according to the instantaneous frequency of the carrier, the voltages across  $C_3$  and  $C_4$  differ proportionately, the voltage across  $C_3$  being the larger of the two voltages at carrier frequencies below the intermediate frequency and the smaller at frequencies above the intermediate frequency. These voltages across  $C_3$  and  $C_4$  are additive and their sum is fixed by the constant voltage across  $C_6$ . Therefore, while the ratio of these voltages varies at an audio rate, their sum is always constant. The voltage across  $C_4$  varies at an audio rate when a frequency-modulated rf carrier is applied to the ratio detector; this audio voltage is extracted and fed to the audio amplifier. For a complete circuit utilizing this type of detector, refer to the CIRCUIT SECTION.

### AUTOMATIC VOLUME CONTROL

The chief purposes of automatic volume control in a receiver are to prevent fluctuations in loudspeaker volume when the signal at the antenna is fading in and out, and to prevent an unpleasant blast of loud volume when the set is tuned from a weak signal, for which the volume control has been turned up high, to a strong signal. To accomplish these purposes, an automatic volume control circuit regulates the receiver's rf and if gain so that this gain is less for a strong signal than for a weak signal. In this way, when the signal strength at the antenna changes, the avc circuit reduces the resultant change in the voltage output of the last if stage and consequently reduces the change in the speaker's output volume.

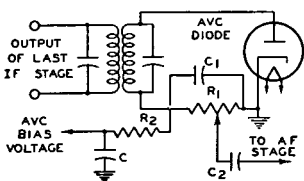

Fig. 53

The avc circuit reduces the rf and if gain for a strong signal usually by increasing the negative bias of the rf, if, and frequency-mixer stages when the signal increases. A simple avc circuit is shown in Fig. 53. On each positive half-cycle of the signal voltage, when the diode plate is positive with respect to the cathode, the diode passes current. Because of the flow of diode current through  $R_1$ , there is a voltage drop across  $R_1$  which makes the left end of  $R_1$  negative with respect to ground. This voltage drop across  $R_1$  is applied, through the filter  $R_2$  and  $C$ , as negative bias on the grids of the preceding stages. Then, when the signal strength at the antenna increases, the signal applied to the avc diode increases, the voltage drop across  $R_1$  increases, the negative bias voltage applied to the rf and if stages increases, and the gain of the rf and if stages is decreased. Thus the increase in signal strength at the antenna does not produce as much increase in the output of the last if stage as it would produce without avc. When the signal strength at the antenna decreases from a previous steady value, the avc circuit acts, of course, in the reverse direction, applying less negative bias, permitting the rf and if gain to increase, and thus reducing the decrease in the signal output of the last if stage. In this way, when the signal strength at the antenna changes, the avc circuit acts to reduce change in the output of the last if stage, and thus acts to reduce change in loudspeaker volume.

The filter,  $C$  and  $R_2$ , prevents the avc voltage from varying at audio frequency. The filter is necessary because the voltage drop across  $R_1$  varies with the modulation of the carrier being received. If avc voltage were taken directly from  $R_1$  without

filtering, the audio variations in avc voltage would vary the receiver's gain so as to smooth out the modulation of the carrier. To avoid this effect, the avc voltage is taken from the capacitor C. Because of the resistance  $R_2$  in series with C, the capacitor C can charge and discharge at only a comparatively slow rate. The avc voltage therefore cannot vary at frequencies as high as the audio range but can vary at frequencies high enough to compensate for most fading. Thus the filter permits the avc circuit to smooth out variations in signal due to fading, but prevents the circuit from smoothing out audio modulation.

It will be seen that an avc circuit and a diode-detector circuit are much alike. It is therefore convenient in a receiver to combine the detector and the avc diode in a single stage. Examples of how these functions are combined in receivers are shown in CIRCUIT SECTION.

In the circuit shown in Fig. 53, a certain amount of avc negative bias is applied to the preceding stages on a weak signal. Since it may be desirable to maintain the receiver's rf and if gain at the maximum possible value for a weak signal, avc circuits are designed in some cases to apply no avc bias until the signal strength exceeds a certain value. These avc circuits are known as delayed avc or davo circuits. A davo circuit is shown in Fig. 54. In this circuit, the diode section  $D_1$ ,

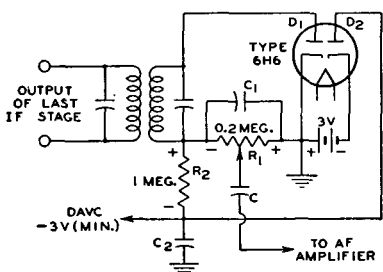

Fig. 54

of the 6H6 acts as detector and avc diode.  $R_1$  is the diode load resistor and  $R_2$  and  $C_2$  are the avc filter. Because the cathode of diode  $D_2$  is returned through a fixed supply of -3 volts to the cathode of  $D_1$ , a dc current flows through  $R_1$  and  $R_2$  in series with  $D_2$ . The voltage drop caused by this current places the avc lead at approximately -3 volts (less the negligible drop through  $D_2$ ). When the average amplitude of the rectified signal developed across  $R_1$  does not exceed 3 volts, the avc lead remains at -3 volts. Hence, for signals not strong enough to develop 3 volts across  $R_1$ , the bias applied to the controlled tubes stays constant at a value giving high sensitivity. However, when the average amplitude of rectified signal voltage across  $R_1$  exceeds 3 volts, the plate of diode  $D_2$  becomes more negative than the cathode of  $D_2$  and current flow in diode  $D_2$  ceases. The potential of the avc lead is then controlled by the voltage developed across  $R_1$ . Therefore, with further increase in signal strength, the avc circuit applies an increasing avc bias voltage to the controlled stages. In this way, the circuit regulates the receiver's gain for strong signals, but permits the gain to stay constant at a maximum value for weak signals.

It can be seen in Fig. 54 that a portion of the -3 volts delay voltage is applied to the plate of the detector diode  $D_1$ , this portion being approximately equal to  $R_1/(R_1 + R_2)$  times -3 volts. Hence, with the circuit constants as shown, the detector plate is made negative with respect to its cathode by approximately one-half volt. However, this voltage does not interfere with detection because it is not large enough to prevent current flow in the tube.

## TUNING INDICATION WITH ELECTRON-RAY TUBES

Electron-ray tubes are designed to indicate visually by means of a fluorescent target the effects of a change in controlling voltage. One application of them is as tuning indicators in radio receivers. Types such as the 6U5, 6E5, and the 6AB5/6N5

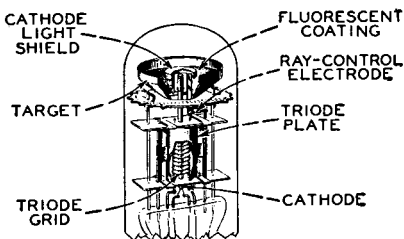

Fig. 55

contain two main parts: (1) a triode which operates as a dc amplifier and (2) an electron-ray indicator which is located in the bulb as shown in Fig. 55. The target is operated at a positive voltage and, therefore, attracts electrons from the cathode. When the electrons strike the target they produce a glow on the fluorescent coating of the target. Under these conditions, the target appears as a ring of light.

A ray-control electrode is mounted between the cathode and target. When the potential of this electrode is less positive than the target, electrons flowing to the target are repelled by the electrostatic field of the electrode, and do not reach that portion of the target behind the electrode. Because the target does not glow where it is shielded from electrons, the control electrode casts a shadow on the glowing target. The extent of this shadow varies from approximately 100° of the target when the control electrode is much more negative than the target to 0° when the control electrode is at approximately the same potential as the target.

In the application of the electron-ray tube, the potential of the control electrode is determined by the voltage on the grid of the triode section, as can be seen in Fig. 56. The flow of the triode plate current through resistor R produces a voltage drop which determines the potential of the control electrode. When the voltage of the triode grid changes in the positive direction, plate current increases, the potential of the control electrode goes down because of the increased drop across R, and the shadow angle widens. When the potential of the triode grid changes in the negative direction, the shadow angle narrows.

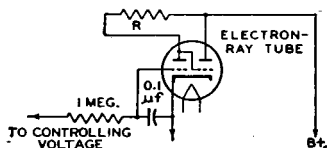

Fig. 56

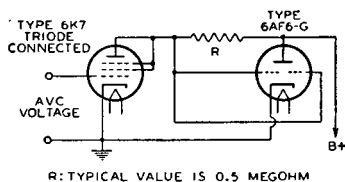

Fig. 57

Another type of indicator tube is the 6AF6-G. This tube contains only an indicator unit but employs two ray-control electrodes mounted on opposite sides of the cathode and connected to individual base pins. It employs an external dc amplifier. (See Fig. 57.) Thus, two symmetrically opposite shadow angles may be obtained by connecting the two ray-control electrodes together; or, two unlike patterns may be obtained by individual connection of each ray-control electrode to its respective amplifier.

In radio receivers, avc voltage is applied to the grid of the dc amplifier. Because avc voltage is at maximum when the set is tuned to give maximum response to a station, the shadow angle is at minimum when the receiver is tuned to resonance with the desired station.

The choice between electron-ray tubes depends on the AVC characteristic of the receiver. The 6E5 contains a sharp-cutoff triode which closes the shadow angle on a comparatively low value of AVC voltage. The 6AB5/6N5 and 6U5 each have a remote-cutoff triode which closes the shadow on a larger value of AVC voltage than the 6E5. The 6AF6-G may be used in conjunction with DC amplifier tubes having either remote- or sharp-cutoff characteristics.

### OSCILLATION

As an oscillator, an electron tube can be employed to generate a continuously alternating voltage. In present-day radio broadcast receivers, this application is limited practically to superheterodyne receivers for supplying the heterodyning frequency. Several circuits (represented in Figs. 58 and 59) may be utilized, but they all depend on feeding more energy from the plate circuit to the grid circuit than is required to equal the power loss in the grid circuit. Feedback may be

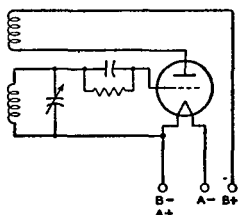

Fig. 58

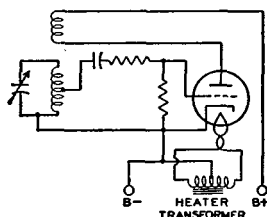

Fig. 59

produced by electrostatic or electromagnetic coupling between the grid and plate circuits. When sufficient energy is fed back to more than compensate for the loss in the grid circuit, the tube will oscillate. The action consists of regular surges of power between the plate and the grid circuit at a frequency dependent on the circuit constants of inductance and capacitance. By proper choice of these values, the frequency may be adjusted over a very wide range.

The **relaxation oscillator** is an oscillator with a non-sinusoidal output. It differs from the preceding type in that the oscillations are obtained by abruptly releasing energy previously stored in the electric field of a capacitor. A **multivibrator** is a special type of relaxation oscillator used in television receivers and other electronic applications. A multivibrator may be considered as a two-stage resistance-coupled amplifier in which the output of each tube is coupled into the input of the other tube in order to sustain oscillations.

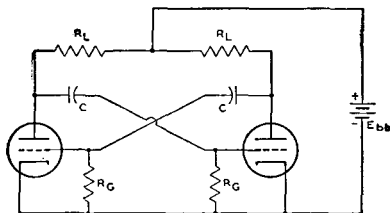

Fig. 60

Fig. 60 is a basic multivibrator circuit of the free-running type. In this circuit, oscillations are maintained by the alternate shifting of conduction from one tube to the other. The cycle starts with one tube usually at zero bias and the other at cutoff or beyond. Each tube introduces a  $180^\circ$  phase shift so that the energy fed back has the phase relation necessary to sustain oscillation. The frequency of oscillation is determined primarily by the constants of the resistance-capacitance coupling circuits.

**FREQUENCY CONVERSION**

Frequency conversion is used in superheterodyne receivers to change the frequency of the rf signal to an intermediate frequency. To perform this change in frequency, a frequency-converting device consisting of an oscillator and a frequency

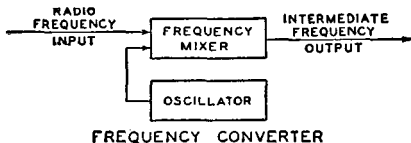

Fig. 61

mixer is employed. In such a device, shown diagrammatically in Fig. 61, two voltages of different frequency, the rf signal voltage and the voltage generated by the oscillator, are applied to the input of the frequency mixer. These voltages beat, or heterodyne, within the mixer tube to produce a plate current having, in addition to the frequencies of the input voltages, numerous sum and difference frequencies. The output circuit of the mixer stage is provided with a tuned circuit which is adjusted to select only one beat frequency, i.e., the frequency equal to the difference between the signal frequency and the oscillator frequency. The selected output frequency is known as the intermediate frequency, or if. The output frequency of the mixer tube is kept constant for all values of signal frequency by tuning the oscillator to the proper frequency.

Important advantages gained in a receiver by the conversion of signal frequency to a fixed intermediate frequency are high selectivity with few tuning stages and a high, as well as stable, overall gain for the receiver.

Several methods of frequency conversion for superheterodyne receivers are of interest. These methods are alike in that they employ a frequency-mixer tube in which plate current is varied at a combination frequency of the signal frequency and the oscillator frequency. These variations in plate current produce across the tuned plate load a voltage of the desired intermediate frequency. The methods differ in the types of tubes employed and in the means of supplying input voltages to the mixer tube.

A method widely used before the availability of tubes especially designed for frequency-conversion service and currently used in many FM, television, and standard broadcast receivers, employs as mixer tube either a triode, a tetrode, or a pentode, in which oscillator voltage and signal voltage are applied to the same grid. In this method, coupling between the oscillator and mixer circuits is obtained by means of inductance or capacitance.

A second method employs a tube having an oscillator and frequency mixer combined in the same envelope. In one form of such a tube, coupling between the two units is obtained by means of the electron stream within the tube. One arrangement of the electrodes for this type is shown in Fig. 62. Because five grids are used, the tube is called a pentagrid converter. Grids No. 1 and No. 2, and the cathode are connected to an external circuit to act as a triode oscillator. Grid No. 1 is the grid of the oscillator and grid No. 2 is the anode. These and the cathode can be considered as a composite cathode which supplies to the rest of the tube an electron stream that varies at the oscillator frequency. This varying electron stream is further controlled by the rf signal voltage on grid No. 4. Thus, the variations in plate current are due to the combination of the oscillator and the signal frequencies. The purpose of grids No. 3 and No. 5, which are connected together within the tube, is to accelerate the electron stream and to shield grid No. 4 electrostatically from the other electrodes. The 6A8 is an example of a pentagrid-converter type.

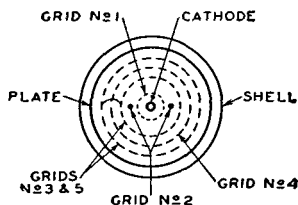

Fig. 62



Pentagrid-converter tubes of this design are good frequency-converting devices at medium frequencies. However, their performance is better at the lower frequencies because the output of the oscillator drops off as the frequency is raised and because certain undesirable effects produced by interaction between oscillator and signal sections of the tube increase with frequency. To minimize these effects, several of the pentagrid-converter tubes are designed so that no electrode functions alone as the oscillator anode. In these tubes, grid No. 1 functions as the oscillator grid,

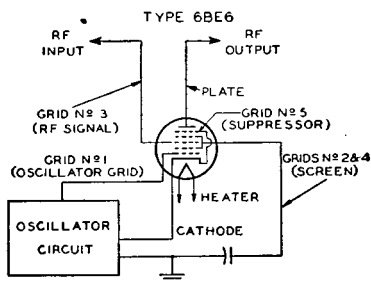

Fig. 62

and grid No. 2 is connected within the tube to the screen (grid No. 4). The combined two grids, Nos. 2 and 4, shield the signal grid (grid No. 3) and act as the composite anode of the oscillator triode. Grid No. 5 acts as the suppressor. Converter tubes of this type are designed so that the space charge around the cathode is unaffected by electrons from the signal grid. Furthermore, the electrostatic field of the signal grid also has little effect on the space charge. The result is that rf voltage on the signal grid produces little effect on the cathode current. There is, therefore, little detuning of the oscillator by avc bias because changes in avc bias produce little change in oscillator transconductance or in the input capacitance of grid No. 1. Examples of the pentagrid converters discussed in this paragraph are the single-ended types 1R5 and 6BE6. A schematic diagram illustrating the use of the 6BE6 with self-excitation is given in Fig. 63; the 6BE6 may also be used with separate excitation. A complete circuit is shown in the CIRCUIT SECTION.

Another method of frequency conversion utilizes a separate oscillator having its grid connected to the No. 1 grid of a mixer hexode. A tube utilizing this construction is the 6K8; a top view of its electrode arrangement is shown in Fig. 64. The cathode, triode grid No. 1, and triode plate form the oscillator unit of the tube.

The cathode, hexode mixer grid (grid No. 1), hexode double-screen (grids Nos. 2 and 4), hexode mixer grid (grid No. 3), and hexode plate constitute the mixer unit. The internal shields are connected to the shell of the tube and act as a suppressor for the hexode unit. The action of the 6K8 in converting a radio-

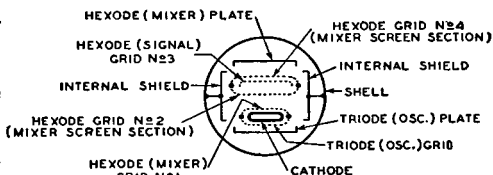

Fig. 64

frequency signal to an intermediate frequency depends on (1) the generation of a local frequency by the triode unit, (2) the transferring of this frequency to the hexode grid No. 1, and (3) the mixing in the hexode unit of this frequency with that of the rf signal applied to the hexode grid No. 3. The 6K8 is not critical to changes in oscillator-plate voltage or signal-grid bias and, therefore, finds important use in all-wave receivers to minimize frequency-shift effects at the higher frequencies.

A further method of frequency conversion employs a tube called a pentagrid mixer. This type has two independent control grids and is used with a separate oscillator tube. RF signal voltage is applied to one of the control grids and oscillator voltage is applied to the other. It follows, therefore, that the variations in plate current are due to the combination of the oscillator and signal frequencies. The arrangement of electrodes in a pentagrid-mixer tube is shown in Fig. 65. The tube contains a heater cathode, five grids, and a plate. Grids Nos. 1 and 3 are control grids. The rf signal voltage is applied to grid No. 1. This grid has a remote-cutoff characteristic and is suited for control by avc bias voltage. The oscillator voltage is applied to grid No. 3. This grid has a sharp-cutoff characteristic and produces a comparatively large effect on plate current for a small amount of oscillator voltage. Grids Nos. 2 and 4 are connected together within the tube. They accelerate the electron stream and shield grid No. 3 electrostatically from the other electrodes. Grid No. 5, connected within the tube to the cathode, functions similarly to the suppressor in a pentode. The 6L7 is a pentagrid-mixer tube.

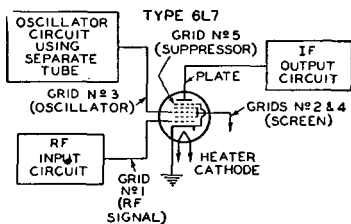

Fig. 65

### AUTOMATIC FREQUENCY CONTROL

An automatic frequency control (afc) circuit provides a means of correcting automatically the intermediate frequency of a superheterodyne receiver if, for any reason, it drifts from the frequency to which the if stages are tuned. This correction is made by adjusting the frequency of the oscillator. Such a circuit will automatically compensate for slight changes in rf carrier or oscillator frequency as well as for inaccurate manual or push-button tuning.

An afc system requires two sections: a frequency detector and a variable reactance. The detector section may be essentially the same as the FM detector illustrated in Fig. 50 and discussed under *Detection*. In the afc system, however, the output is a dc control voltage, the magnitude of which is proportional to the amount of frequency shift. This dc control voltage is used to control the grid bias of an electron tube which comprises the variable reactance section (Fig. 66). The

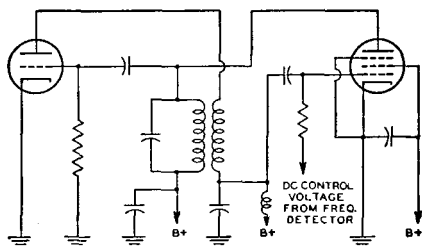

Fig. 66

plate current of the reactance tube is shunted across the oscillator tank circuit. Because the plate current and plate voltage of the reactance tube are almost 90° out of phase, the control tube affects the tank circuit in the same manner as a reactance. The grid bias of the tube determines the magnitude of the effective reactance and, consequently, a control of this grid bias can be used to control the oscillator frequency.

# Electron Tube Installation

The installation of electron tubes requires care if high-quality performance is to be obtained from the associated circuits. Installation suggestions and precautions which are generally common to all types of tubes are covered in this section. Careful observance of these suggestions will do much to help the experimenter and electronic technician obtain the full performance capabilities of radio tubes and circuits. Additional pertinent information is given under each tube type and in the CIRCUIT SECTION.

## FILAMENT AND HEATER POWER SUPPLY

The design of electron tubes allows for some variation in the voltage and current supplied to the filament or heater, but most satisfactory results are obtained from operation at the rated values. When the voltage is low, the temperature of the cathode is below normal, with the result that electron emission is limited. The limited emission may cause unsatisfactory operation and reduced tube life. On the other hand, high cathode voltage may cause rapid evaporation of cathode material and shorten tube life. To insure proper tube operation, it is important that the filament or heater voltage be checked at the socket terminals by means of a high-resistance voltmeter while the equipment is in operation. In the case of series operation of heaters or filaments, correct adjustment can be checked by means of an ammeter in the heater or filament circuit.

The filament or heater voltage supply may be a direct-current source (a battery or a dc power line) or an alternating-current power line, depending on the type of service and type of tube. Frequently, a resistor (either variable or fixed) is used with a dc supply to permit compensation for battery voltage variations or to adjust the tube voltage at the socket terminals to the correct value. Ordinarily, a step-down transformer is used with an ac supply to provide the proper filament or heater voltage. Receivers intended for operation on both dc and ac power lines have the heaters connected in series with a suitable resistor and supplied directly from the power line.

DC filament or heater operation should be considered on the basis of the source of power. In the case of the battery supply for the 1.4-volt filament tubes, it is unnecessary to use a voltage-dropping resistor in series with the filament and a single dry-cell; the filaments of these tubes are designed to operate satisfactorily over the range of voltage variations that normally occur during the life of a dry-cell. Likewise, no series resistor is required when the 1.25-volt filament subminiatures are operated from a single 1.5-volt flashlight-type dry-cell, when the 2-volt filament type tubes are operated from a single storage cell, or when the 6.3-volt series are operated from a 6-volt storage battery. In the case of dry-battery supply for 2-volt filament tubes, a variable resistor in series with the filament and the battery is required to compensate for battery variations. Turning the set on and off by means of the rheostat is advised to prevent over-voltage conditions after an off-period because the voltage of dry-cells rises during off-periods. In the case of storage-battery supply, air-cell-battery supply, or dc power supply, a non-adjustable resistor of suitable value may be used. It is well to check initial operating conditions, and thus the resistor value, by means of a voltmeter or ammeter.

The filament or heater resistor required when filaments and/or heaters are operated in parallel can be determined easily by a simple formula derived from Ohm's law.

$$\text{Required resistance (ohms)} = \frac{\text{supply volts} - \text{rated volts of tube type}}{\text{total rated filament current (amperes)}}$$

Thus, if a receiver using three 32's, two 30's, and two 31's is to be operated from dry batteries, the series resistor is equal to 3 volts (the voltage from two dry-cells in series) minus 2 volts (voltage rating for these tubes) divided by 0.56 ampere (the sum of  $5 \times 0.060$  ampere +  $2 \times 0.130$  ampere), i.e., approximately 1.8 ohms. Since this resistor should be variable to allow adjustment for battery depreciation, it is advisable to obtain the next larger commercial size, although any value between 2 and 3 ohms will be quite satisfactory. Where much power is dissipated in the resistor, the wattage rating should be sufficiently large to prevent overheating. The power dissipation in watts is equal to the voltage drop in the resistor multiplied by the total filament current in amperes. Thus, for the example above  $1 \times 0.56 = 0.56$  watt. In this case, the value is so small that any commercial rheostat with suitable resistance will be adequate.

For the case where the heaters and/or filaments of several tubes are operated in series, the resistor value is calculated by the following formula, also derived from Ohm's law.

$$\text{Required resistance (ohms)} = \frac{\text{supply volts} - \text{total rated volts of tubes}}{\text{rated amperes of tubes}}$$

Thus, if a receiver having one 6SA7, one 6SK7, one 6SF7, one 25L6-GT, and one 25Z6-GT is to be operated from a 117-volt power line, the series resistor is equal to 117 volts (the supply voltage) minus 68.9 volts (the sum of  $3 \times 6.3$  volts +  $2 \times 25$  volts) divided by 0.3 ampere (current rating of these tubes), i.e., approximately 160 ohms. The wattage dissipation in the resistor will be 117 volts minus 68.9 volts times 0.3 ampere, or approximately 14.4 watts. A resistor having a wattage rating in excess of this value should be chosen.

When the series-heater connection is used in ac/dc receivers, it is usually advisable to arrange the heaters in the circuit so that the tubes most sensitive to hum disturbances are at or near the ground potential of the circuit. This arrangement reduces the amount of ac voltage between the heaters and cathodes of these tubes and minimizes the hum output of the receiver. The order of heater connection, by tube function, from chassis to the rectifier-cathode side of the ac line is shown in Fig. 67.

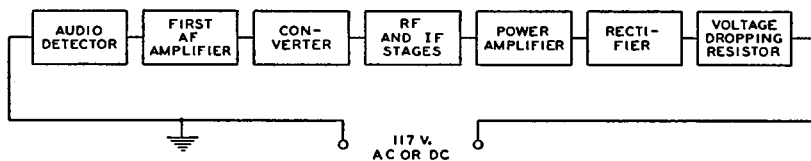

Fig. 67

**AC filament or heater operation** should be considered on the basis of either a parallel or a series arrangement of filaments and/or heaters. In the case of the parallel arrangement, a step-down transformer is employed. Precautions should be taken to see that the line voltage is the same as that for which the primary of the transformer is designed. The line voltage may be determined by measurement with an ac voltmeter (0-150 volts).

If the line voltage measures in excess of that for which the transformer is designed, a resistor should be placed in series with the primary to reduce the line voltage to the rated value of the transformer primary. Unless this is done, the excess input voltage will cause proportionally excessive voltage to be applied to the tubes. Any electron tube may be damaged or made inoperative by excessive operating voltages.

If the line voltage is consistently below that for which the primary of the transformer is designed, it may be necessary to install a booster transformer between the ac outlet and the transformer primary. Before such a transformer is installed, the ac line fluctuations should be very carefully noted. Some radio sets are equipped with a line-voltage switch which permits adjustment of the power transformer primary to the line voltage. When this switch is properly adjusted, the series-resistor or booster-transformer method of controlling line voltage is seldom required.

In the case of the series arrangements of filaments and/or heaters, a voltage-dropping resistance in series with the heaters and the supply line is usually required. This resistance should be of such value that, for normal line voltage, tubes will operate at their rated heater or filament current. The method for calculating the resistor value is given above.

When the filaments of battery-type tubes are connected in series, the total filament current is the sum of the current due to the filament supply and the plate and grid-No.2 currents (cathode current) returning to B(-) through the tube filaments. Consequently, in a series filament string it is necessary to add shunt resistors across each filament section to bypass this cathode current in order to maintain the filament voltage at its rated value.

### **HEATER-TO-CATHODE CONNECTION**

The cathodes of heater-type tubes, when operated from ac, should be connected to the mid-tap on the heater supply winding, to the mid-tap of a 50-ohm (approximate) resistor shunted across the winding, or to one end of the heater supply winding depending on circuit requirements. If none of these methods is used, it is important to keep the heater-cathode voltage within the ratings given in the TUBE TYPES SECTION.

Hum from ac-operated heater tubes used in high-gain audio amplifiers may frequently be reduced to a negligible value by employing a 15- to 40-volt bias between the heater and cathode elements of the tubes. The bias should be connected so that the tube heater is positive with respect to its cathode. Such bias can be obtained from the regular plate-supply rectifier of the amplifier.

If a large resistor is used between heater and cathode, it should be bypassed by a suitable capacitor or objectionable hum may develop. The hum is due to the fact that even a minute pulsating leakage current flowing between the heater and cathode will develop a small voltage across any resistance in the circuit. This hum voltage is amplified by succeeding stages.

### **PLATE VOLTAGE SUPPLY**

The plate voltage for electron tubes is obtained from batteries, rectifiers, direct-current power lines, and small local generators. The maximum plate-voltage value for any tube type should not be exceeded if most satisfactory performance is to be obtained. Plate voltage should not be applied to a tube unless the corresponding recommended voltage is also supplied to the grid.

It is recommended that the primary circuit of the power transformer be fused to protect the rectifier tube(s), the power transformer, filter capacitor, and chokes in case a rectifier tube fails.

### **GRID VOLTAGE SUPPLY**

The recommended grid voltages for different operating conditions have been carefully determined to give the most satisfactory performance. Grid voltage may be obtained from a fixed source such as a separate C-battery or a tap on the voltage divider of the high-voltage dc supply from the voltage drop across a resistor in the

cathode circuit, or from the voltage drop across a resistor in the grid circuit. The first method is called "fixed bias"; the second is called "cathode bias" or "self bias"; the third is called "grid-resistor bias" and is sometimes incorrectly referred to in receiving-tube practice as "zero-bias operation." In any case, the object is to make the grid negative with respect to the cathode by the specified voltage. When a C-battery is used, the negative terminal is connected to the grid return and the positive terminal is connected to the negative filament socket terminal, or to the cathode terminal if the tube is of the heater-cathode type. If the filament is supplied with alternating current, this connection is usually made to the center-tap of a low resistance (20-50 ohms) shunted across the filament terminals. This method reduces hum disturbances caused by the ac supply. If bias voltages are obtained from the voltage divider of a high-voltage dc supply, the grid return is connected to a more negative tap than the cathode.

The **cathode-biasing** method utilizes the voltage drop produced by the cathode current flowing through a resistor connected between the cathode and the negative terminal of the B-supply. (See Fig. 68.) The cathode current is, of course,

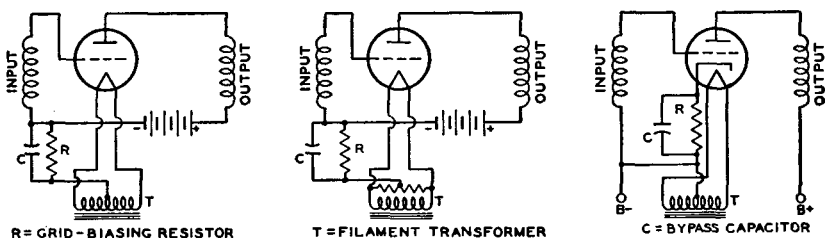

Fig. 68

equal to the plate current in the case of a triode, or to the sum of the plate and grid-No.2 currents in the case of a tetrode, pentode, or beam power tube. Because the voltage drop along the resistance is increasingly negative with respect to the cathode, the required negative grid-bias voltage can be obtained by connecting the grid return to the negative end of the resistance.

The value of the resistance for cathode-biasing a single tube can be determined from the following formula:

$$\text{Resistance (ohms)} = \frac{\text{desired grid-bias voltage} \times 1000}{\text{rated cathode current in milliamperes}}$$

Thus, the resistance required to produce 9 volts bias for a triode which operates at 3 milliamperes plate current is  $9 \times 1000/3 = 3000$  ohms. If the cathode current of more than one tube passes through the resistor, or if the tube or tubes employ more than three electrodes, the total current determines the size of the resistor.

**Bypassing** of the cathode-bias resistor depends on circuit-design requirements. In rf circuits the cathode resistor usually is bypassed. In af circuits the use of an unbypassed resistor will reduce distortion by introducing degeneration into the circuit. However, the use of an unbypassed resistor decreases gain and power sensitivity. When bypassing is used, it is important that the bypass capacitor be sufficiently large to have negligible reactance at the lowest frequency to be amplified. In the case of power-output tubes having high transconductance such as the beam power tubes, it may be necessary to shunt the bias resistor with a small mica capacitor (approximately 0.001 $\mu$ f) in order to prevent oscillations. The usual af bypass may or may not be used, depending on whether or not degeneration is desired. In tubes having high values of transconductance, such as the 6BA6, 6CB6, and 6AC7, input capacitance and input conductance change appreciably

with plate current. When such a tube having a separate suppressor connection is used as an rf amplifier, these changes may be minimized by leaving a certain portion of the cathode-bias resistor unbypassed. In order to minimize feedback when this method is used, the external grid-No.1-to-plate (wiring) capacitances should be kept to a minimum, the grid No.2 should be bypassed to ac ground, and the grid No.3 should be connected to ac ground. The use of a cathode resistor to obtain bias voltage is not recommended for amplifiers in which there is appreciable shift of electrode currents with the application of a signal. In such amplifiers, a separate fixed supply is recommended.

The **grid-resistor biasing** method is also a self-bias method because it utilizes the voltage drop across the grid resistor produced by small amounts of grid current flowing in the grid-cathode circuit. This current is due to (1) an electromotive potential difference between the materials comprising the grid and cathode and (2) grid rectification when the grid is driven positive. A large value of resistance is required in order to limit this current to a very small value and to avoid undesirable loading effects on the preceding stage. Examples of this method of bias are given in circuits 17-1 and 17-4 in the **CIRCUIT SECTION**. In both of these circuits, the audio amplifier type 1U5 or 12AV6 has a 10-megohm resistor between the grid and the negative filament or cathode to furnish the required bias which is usually less than 1 volt. This method of biasing is used principally in the early voltage amplifier stages (usually employing high- $\mu$  triodes) of audio amplifier circuits, where the tube dissipation will not be excessive under zero-signal conditions.

A grid resistor is also used in many oscillator circuits for obtaining the required bias. In these circuits, the grid voltage is relatively constant and its magnitude is usually in the order of 5 volts or more. Consequently, the bias voltage is obtained only through grid rectification. A relatively low value of resistor, 0.1 megohm or less, is used. Oscillator circuits employing this method of bias are given in circuits 17-1 and 17-4 in the **CIRCUIT SECTION**.

**Grid-bias variation** for the rf and if amplifier stages is a convenient and frequently used method for controlling receiver volume. The variable voltage supplied to the grid may be obtained: (1) from a variable cathode resistor as shown in Figs. 69 and 70; (2) from a bleeder circuit by means of a potentiometer as shown in Fig. 71; or (3) from a bleeder circuit in which the bleeder current is varied by a tube used for automatic volume control. The latter circuit is shown in Fig. 53.

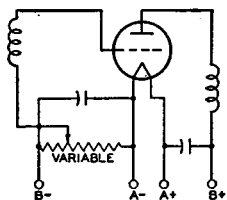

Fig. 69

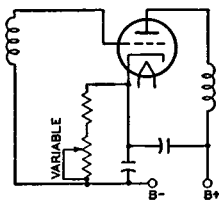

Fig. 70

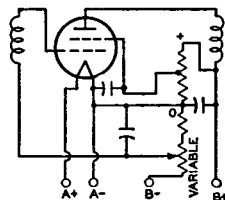

Fig. 71

In all cases it is important that the control be arranged so that at no time will the bias be less than the recommended minimum grid-bias voltage for the particular tubes used. This requirement can be met by providing a fixed stop on the potentiometer, by connecting a fixed resistance in series with the variable resistance, or by connecting a fixed cathode resistance in series with the variable resistance used for regulation. Where receiver gain is controlled by grid-bias variation, it is advisable to have the control voltages extend over a wide range in order to minimize cross-modulation and modulation-distortion. A remote-cutoff type of tube should, therefore, be used in the controlled stages.

In most tubes employing a unipotential cathode, a positive grid current begins to flow when the grid is slightly negative and increases rapidly as the grid is made more positive, as shown in Fig. 72. The value of grid voltage at which positive grid current starts to flow is generally referred to as **contact potential**. Contact potential

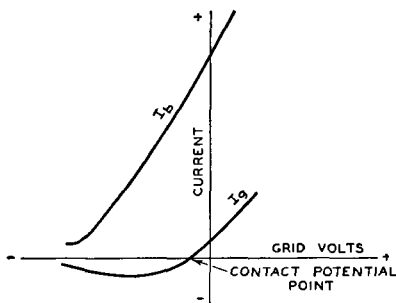

Fig. 72

is caused by the initial velocity of emission of electrons from the cathode and an electrothermal effect due to the differences in temperature and in material composition of the grid and the cathode. The value of this voltage may be as high as  $1\frac{1}{2}$  volts. If the operating bias of the tube is less than the contact potential, it is found that two effects are present. Direct current flows in the grid circuit, and the dynamic input resistance of the tube may be relatively low. It is generally desirable to supply the tube with a value of bias sufficiently high so that the tube is not operating within the contact-potential region. When a tube must be operated within this region, care should be taken to avoid undesirable effects in the grid circuit due to grid current or low input resistance.

### SCREEN VOLTAGE SUPPLY

The positive voltage for the screen (grid No. 2) of screen-grid tubes may be obtained from a tap on a voltage divider, from a potentiometer, or from a series resistor connected to a high-voltage source, depending on the particular tube type and its application. The screen voltage for tetrodes should be obtained from a voltage divider or a potentiometer rather than through a series resistor from a high-voltage source because of the characteristic screen-current variations of tetrodes. Fig. 73 shows a tetrode with its screen voltage obtained from a potentiometer. When pentodes or beam power tubes are operated under conditions where a large shift of plate and screen currents does not take place with the application of the signal, the screen voltage may be obtained through a series

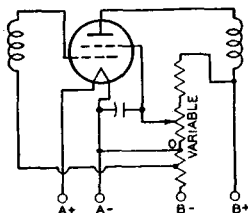

Fig. 73

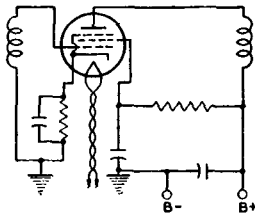

Fig. 74

resistor from a high-voltage source. This method of supply is possible because of the high uniformity of the screen-current characteristic in pentodes and beam power tubes. Because the screen voltage rises with increase in bias and resulting decrease in screen current, the cutoff characteristic of a pentode is extended by this method of supply. The method is sometimes used to increase the range of signals



which can be handled by a pentode. When used in resistance-coupled amplifier circuits employing pentodes in combination with the cathode-biasing method, it minimizes the need for circuit adjustments. Fig. 74 shows a pentode with its screen voltage supplied through a series resistor.

When power pentodes and beam power tubes are operated under conditions such that there is a large change in plate and screen currents with the application of signal, the series-resistor method of obtaining screen voltage should not be used. A change in screen current appears as a change in the voltage drop across the series resistor in the screen circuit; the result is a change in the power output and an increase in distortion. The screen voltage should be obtained from a point in the plate-voltage-supply filter system having the correct voltage, or from a separate source.

It is important to note that the plate voltage of tetrodes, pentodes, and beam power tubes should be applied before or simultaneously with the screen voltage. Otherwise, with voltage on the screen only, the screen current may rise high enough to cause excessive screen dissipation.

**Screen-voltage variation** for the rf amplifier stages has sometimes been used for volume control in older-type receivers. Reduced screen voltage lowers the transconductance of the tube and results in reduced gain per stage. The voltage variation is obtained by means of a potentiometer shunted across the screen voltage supply. (See Fig. 73.) When the screen voltage is varied, it must never exceed the rating of the tube. This requirement can be met by providing a fixed stop on the potentiometer.

## SHIELDING

In high-frequency stages having high gain, the output circuit of each stage must be shielded from the input circuit of that stage. Each high-frequency stage also must be shielded from the other high-frequency stages. Unless shielding is employed, undesired feedback may occur and may produce many harmful effects on receiver performance. To prevent this feedback, it is a desirable practice to shield separately each unit of the high-frequency stages. For instance, in a super-heterodyne receiver, each if and rf coil may be mounted in a separate shield can. Baffle plates may be mounted on the ganged tuning capacitor to shield each section of the capacitor from the other sections. The oscillator coil may be especially well shielded by being mounted under the chassis. The shielding precautions required in a receiver depend on the design of the receiver and the layout of the parts. In all receivers having high-gain high-frequency stages, it is necessary to shield separately each tube in high-frequency stages. When metal tubes, and in particular the single-ended types, are used, complete shielding of each tube is provided by the metal shell which is grounded through its grounding pin at the socket terminal. The grounding connection should be short and sturdy. Many modern tubes of glass construction have internal shields, usually connected to the cathode; where present, these shields are indicated in the socket diagram.

## DRESS OF CIRCUIT LEADS

At high frequencies such as are encountered in FM and television receivers, lead dress, that is, the location and arrangement of the leads used for connections in the receiver, is very important. Because even a short lead provides a large impedance at high frequencies, it is necessary to keep all high-frequency leads as short as possible. This precaution is especially important for ground connections and for all connections to bypass capacitors and hf filter capacitors. The ground connections of plate and screen bypass capacitors of each tube should be kept short and made directly to cathode ground.

Particular care should be taken with the lead dress of the input and output circuits of hf stages so that the possibility of stray coupling is minimized. Un-

shielded leads connected to shielded components should be dressed close to the chassis. As the frequency increases, the need for paying careful attention to lead dress becomes increasingly important.

In high-gain audio amplifiers, these same precautions should be taken to minimize the possibility of self-oscillation.

### FILTERS

Feedback effects also are caused in radio receivers by coupling between stages through common voltage-supply circuits. Filters find an important use in minimizing such effects. They should be placed in voltage-supply leads to each tube in

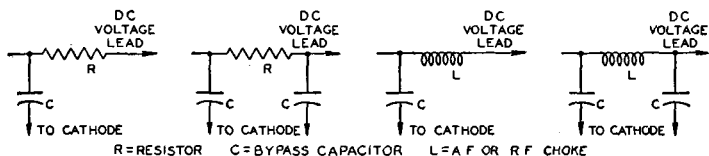

Fig. 75

order to return the signal current through a low-impedance path direct to the tube cathode rather than by way of the voltage-supply circuit. Fig. 75 illustrates several forms of filter circuits. Capacitor C forms the low-impedance path, while the choke or resistor assists in diverting the signal through the capacitor by offering a high impedance to the power-supply circuit.

The choice between a resistor and a choke depends chiefly upon the permissible dc voltage drop through the filter. In circuits where the current is small (a few milliamperes), resistors are practical; where the current is large or regulation important, chokes are more suitable.

The minimum practical size of the capacitors may be estimated in most cases by the following rule: The impedance of the capacitor at the lowest frequency amplified should not be more than one-fifth of the impedance of the filter choke or resistor at that frequency. Better results will be obtained in special cases if the ratio is not more than one-tenth. Radio-frequency circuits, particularly at high frequencies, require high-quality capacitors. Mica or ceramic capacitors are preferable. Where stage shields are employed, filters should be placed within the shield.

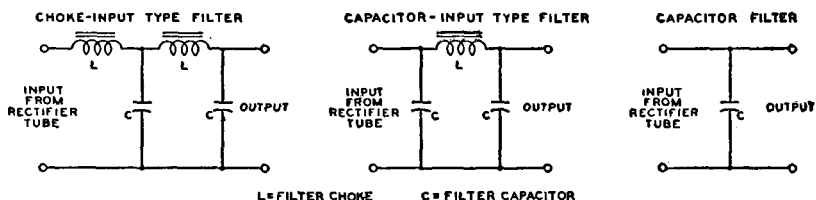

Fig. 76

Another important application of filters is to smooth the output of a rectifier tube. See *Rectification*. A smoothing filter usually consists of capacitors and iron-core chokes. In any filter-design problem, the load impedance must be considered as an integral part of the filter because the load is an important factor in filter performance. Smoothing effect is obtained from the chokes because they are in series with the load and offer a high impedance to the ripple voltage. Smoothing effect is obtained from the capacitors because they are in parallel with the load and store energy on the voltage peaks; this energy is released on the voltage dips and serves to maintain the voltage at the load substantially constant. Smoothing filters are classified as choke-input or capacitor-input according to whether a choke or capacitor is placed next to the rectifier tube. See Fig. 76.

The **CIRCUIT SECTION** gives a number of examples of rectifier circuits with recommended filter constants.

If an input capacitor is used, consideration must be given to the instantaneous peak value of the ac input voltage. This peak value is about 1.4 times the rms value as measured by an ac voltmeter. Filter capacitors, therefore, especially the input capacitor, should have a rating high enough to withstand the instantaneous peak value if breakdown is to be avoided. When the input-choke method is used, the available dc output voltage will be somewhat lower than with the input-capacitor method for a given ac plate voltage. However, improved regulation together with lower peak current will be obtained.

Mercury-vapor and gas-filled rectifier tubes occasionally produce a form of local interference in radio receivers through direct radiation or through the power line. This interference is generally identified in the receiver as a broadly tunable 120-cycle buzz (100 cycles for 50-cycle supply line, etc.). It is usually caused by the formation of a steep wave front when plate current within the tube begins to flow on the positive half of each cycle of the ac supply voltage. There are several ways of eliminating this type of interference. One is to shield the tube. Another is to insert an rf choke having an inductance of one millihenry or more between each plate and transformer winding and to connect high-voltage, rf bypass capacitors between the outside ends of the transformer winding and the center tap. (See Fig. 77.) The rf chokes should be placed within the shielding of the tube. The rf bypass capacitors should have a voltage rating high enough to withstand the peak voltage of each half of the secondary, which is approximately 1.4 times the

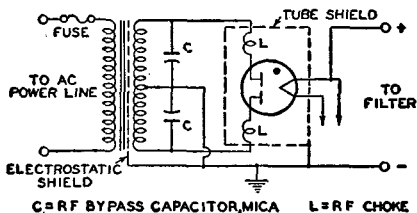

Fig. 77

rms value. Transformers having electrostatic shielding between primary and secondary are not likely to transmit rf disturbances to the line. Often the interference may be eliminated simply by making the plate leads of the rectifier extremely short. In general, the particular method of interference elimination must be selected by experiment for each installation.

### OUTPUT-COUPLING DEVICES

An output-coupling device is used in the plate circuit of a power output tube to keep the comparatively high dc plate current from the winding of an electro-

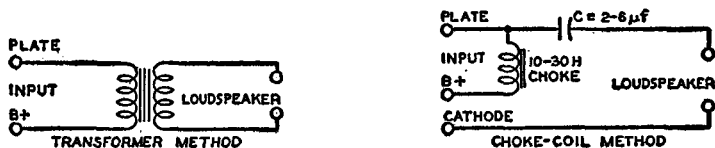

Fig. 78

magnetic speaker and, also, to transfer power efficiently from the output stage to a loudspeaker of either the electromagnetic or dynamic type.

Output-coupling devices are of two types, (1) choke-capacitor and (2) transformer. The choke-capacitor type includes an iron-core choke having an inductance of not less than 10 henries which is placed in series with the plate and B-supply. The choke offers a very low resistance to the dc plate current component of the signal voltage but opposes the flow of the fluctuating component. A bypass capacitor of 2 to 6 microfarads supplies a path to the speaker winding for the signal voltage. The choke-coil output-coupling device, however, is now only of historical interest. The transformer type is constructed with two separate windings, a primary and a secondary wound on an iron core. This construction permits designing each winding to meet the requirements of its position in the circuit. Typical arrangements of each type of coupling device are shown in Fig. 78. Examples of transformers for push-pull stages are shown in several of the circuits given in the **CIRCUIT SECTION**.

## **HIGH-VOLTAGE CONSIDERATIONS FOR KINESCOPES**

Like other high-voltage devices, kinescopes require that certain precautions be observed to minimize the possibility of failure caused by humidity, dust, and corona.

**Humidity Considerations.** When humidity is high, a continuous film of moisture may form on the glass bulb immediately surrounding the ultor cavity cap of all-glass kinescopes or on the glass part of the cone of metal kinescopes. This film may permit sparking to take place over the glass surface to the external conductive coating or to the metal cone. Such sparking may introduce noise into the receiver. To prevent such a possibility, the uncoated bulb surface around the cap and the glass part of the cone of metal kinescopes should be kept clean and dry.

**Dust Considerations.** The accumulation of dust on the uncoated area of the bulb around the ultor cap of all-glass kinescopes or on the glass part of the cone or insulating supports for metal kinescopes will decrease the insulating qualities of these parts. The dust usually consists of fibrous materials and may contain soluble salts. The fibers absorb and retain moisture; the soluble salts provide electrical leakage paths that increase in conductivity as the humidity increases. The resulting high leakage currents may overload the high-voltage power supply. It is recommended, therefore, that the uncoated bulb surface of all-glass kinescopes and the coated glass surface and insulating supports for metal kinescopes be kept clean and free from dust or other contamination such as finger-prints. The coated glass surface of the metal kinescopes may be cleaned with a soapless detergent, such as Dreft, then rinsed with clean water, and immediately dried.

**Corona Considerations.** A high-voltage system may be subject to corona, especially when the humidity is high, unless suitable precautions are taken. Corona, which is an electrical discharge appearing on the surface of a conductor when the voltage gradient exceeds the breakdown value of air, causes deterioration of organic insulating materials through formation of ozone, and induces arc-over at points and sharp edges. Sharp points or other irregularities on any part of the high-voltage system may increase the possibility of corona and should be avoided. In the metal-cone kinescopes, the metal lip at the maximum diameter has rounded edges to prevent corona. Adequate spacing between the lip and any grounded element in the receiver, or between the small end of the metal cone and any grounded element, should be provided to preclude the possibility of corona. Such spacing should not be less than 1 inch of air. Similarly, an air space of 1 inch, or equivalent, should be provided around the body of the metal cone. As a further precaution to prevent corona, the deflecting-yoke surface on the end adjacent to the cone should present a smooth electrical surface with respect to the small end of the metal cone or the ultor terminal of all-glass tubes.

## **KINESCOPE SAFETY CONSIDERATIONS**

**Tube Handling.** Breakage of kinescopes, which contain a high vacuum, may result in injury from flying glass. Do not strike or scratch the tube or subject it to more than moderate pressure when installing it in or removing it from electronic equipment.

**High-Voltage Precautions.** In the use of kinescopes, it should always be remembered that high voltages may appear at normally low-potential points in the circuit because of capacitor breakdown or incorrect circuit connections. Therefore, before any part of the circuit is touched the power-supply switch should be turned off, the power plug disconnected, and both terminals of any capacitors grounded.

**X-Ray Radiation Precautions.** All types of picture tubes may be operated at voltages (if ratings permit) up to 16 kilovolts without producing harmful x-ray radiation and without danger of personal injury on prolonged exposure at close range. Above 16 kilovolts, special x-ray shielding precautions may be necessary.

# Interpretation of Tube Data

The tube data given in the following TUBE TYPES SECTION include ratings, typical operation values, characteristics, and characteristic curves.

The values for grid-bias voltages, electrode voltages, and electrode supply voltages are given with reference to a specified datum point as follows: For types having filaments heated with dc, the negative filament terminal is taken as the datum point to which other electrode voltages are referred. For types having filaments heated with ac, the mid-point (i.e., the center tap on the filament-transformer secondary, or the mid-point on a resistor shunting the filament) is taken as the datum point. For types having unipotential cathodes indirectly heated, the cathode is taken as the datum point.

Electrode voltage and current ratings are in general self-explanatory, but a brief explanation of other ratings will aid in the understanding and interpretation of tube data.

**Plate dissipation** is the power dissipated in the form of heat by the plate as a result of electron bombardment. It is the difference between the power supplied to the plate of the tube and the power delivered by the tube to the load.

**Grid-No. 2 (Screen) Input** is the power applied to the grid-No. 2 electrode and consists essentially of the power dissipated in the form of heat by grid No. 2 as a result of electron bombardment. With tetrodes and pentodes, the power dissipated in the screen circuit is added to the power in the plate circuit to obtain the total B-supply input power.

**Peak heater-cathode voltage** is the highest instantaneous value of voltage that a tube can safely stand between its heater and cathode. This rating is applied to tubes having a separate cathode terminal and used in applications where excessive voltage may be introduced between heater and cathode.

**Maximum peak inverse plate voltage** is the highest instantaneous plate voltage which the tube can withstand recurrently in the direction opposite to that in which it is designed to pass current. For mercury-vapor tubes and gas-filled tubes, it is the safe top value to prevent arc-back in the tube operating within the specified temperature range. Referring to Fig. 79, when plate A of a full-wave rectifier

tube is positive, current flows from A to C, but not from B to C, because B is negative. At the instant plate A is positive, the filament is positive (at high voltage) with respect to plate B. The voltage between the positive filament and the negative plate B is in inverse relation to that causing current flow. The peak value of this voltage is limited by the resistance and nature of the path between plate B and filament. The maximum value of this voltage at which there is no danger of breakdown of the tube is known as maximum peak inverse voltage. The relations between peak inverse voltage, rms value of ac input voltage, and dc output voltage depend largely on the individual characteristics of the

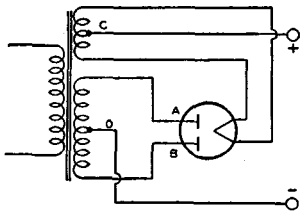

Fig. 79

rectifier circuit and the power supply. The presence of line surges or any other transient, or wave-form distortion, may raise the actual peak voltage to a value higher than that calculated for sine-wave voltages. Therefore, the actual inverse voltage, and not the calculated value, should be such as not to exceed the rated maximum peak inverse voltage for the rectifier tube. A calibrated cathode-ray

oscillograph or a peak-indicating electronic voltmeter is useful in determining the actual peak inverse voltage. In single-phase, full-wave circuits with sine-wave input and with no capacitor across the output, the peak inverse voltage on a rectifier tube is approximately 1.4 times the rms value of the plate voltage applied to the tube. In single-phase, half-wave circuits with sine-wave input and with capacitor input to the filter, the peak inverse voltage may be as high as 2.8 times the rms value of the applied plate voltage. In polyphase circuits, mathematical determination of peak inverse voltage requires the use of vectors.

**Maximum dc output current** is the highest average plate current which can be handled continuously by a rectifier tube. Its value for any rectifier tube type is based on the permissible plate dissipation of that type. Under operating conditions involving a rapidly repeating duty cycle (steady load), the average plate current may be measured with a dc meter. Curves of average plate characteristics for several half-wave vacuum rectifiers are given in Figs. 80 and 81. These curves are shown solid up to the maximum average or dc plate-current rating of each type.

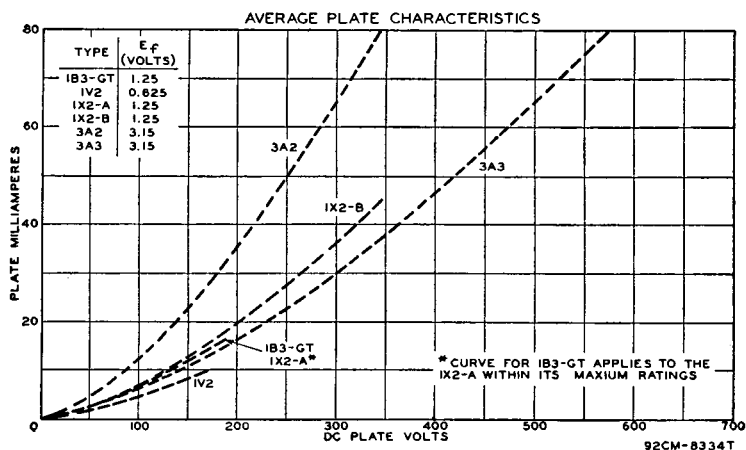

Fig. 80

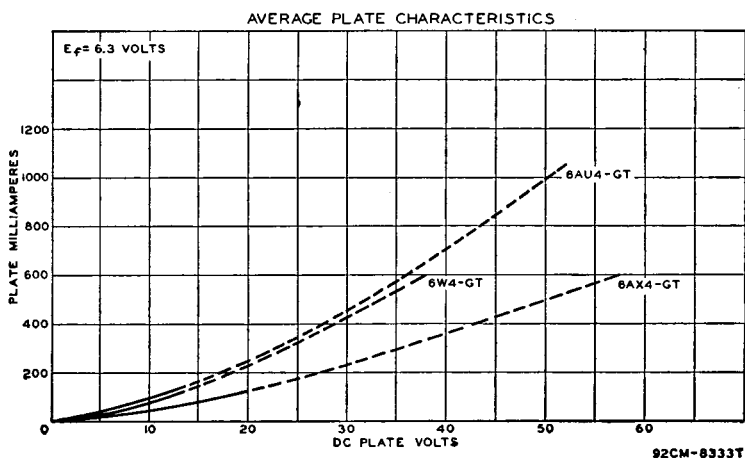

Fig. 81

**Maximum peak plate current** is the highest instantaneous plate current that a tube can safely carry recurrently in the direction of normal current flow. The safe value of this peak current in hot-cathode types of rectifier tubes is a function of the electron emission available and the duration of the pulsating current flow from the rectifier tube in each half-cycle.

The value of peak plate current in a given rectifier circuit is largely determined by filter constants. If a large choke is used at the filter input, the peak plate current is not much greater than the load current; but if a large capacitor is used at the filter input, the peak current may be many times the load current. In order to determine accurately the peak plate current in any rectifier circuit, measure it with a peak-indicating meter or use an oscillograph.

**Typical Operation Values.** Values for typical operation are given for many types in the TUBE TYPES SECTION. These typical operating values are given to show concisely some guiding information for the use of each type. These values should not be confused with ratings, because a tube can be used under any suitable conditions within its maximum ratings, according to the application.

The power output value for any operating condition is an approximate tube output—that is, plate input minus plate loss. Circuit losses must be subtracted from tube output in order to determine the useful output.

**Characteristics** are covered in the ELECTRON TUBE CHARACTERISTICS SECTION and such data should be interpreted in accordance with the definitions given in that section. **Characteristic curves** represent the characteristics of an average tube. Individual tubes, like any manufactured product, may have characteristics that range above or below the values given in the characteristic curves.

Although some curves are extended well beyond the maximum ratings of the tube, this extension has been made only for convenience in calculations. Do NOT operate a tube outside of its maximum ratings.

**Interelectrode capacitances** are direct capacitances measured between specified elements or groups of elements in electron tubes. Unless otherwise indicated in the data, all capacitances are measured with filament or heater cold, with no direct voltages present, and with no external shields. All electrodes other than those between which capacitance is being measured are grounded. In twin or multi-unit types, inactive units are also grounded.

The capacitance between the input electrode and all other electrodes, except the output electrode, connected together is commonly known as the input capacitance. The capacitance between the output electrode and all other electrodes, except the input electrode, connected together is known as the output capacitance.

**Ratings** for receiving-type tubes are given according to the "design-center" system, which was adopted by the industry in 1939, and should be interpreted as follows:

**1. CATHODE**—The heater or filament voltage is given as a normal value unless otherwise stated. This means that transformers or resistances in the heater or filament circuit should be designed to operate the heater or filament at rated value for full-load operating conditions under average supply-voltage conditions. A reasonable amount of leeway is incorporated in the cathode design so that moderate fluctuations of heater or filament voltage downward will not cause marked falling off in response; also moderate voltage fluctuations upward will not reduce the life of the cathode to an unsatisfactory degree.

**A. 1.4-Volt Battery Tube Types**—The filament power supply may be obtained from dry-cell batteries, from storage batteries, or from a power line. With dry-cell



battery supply, the filament may be connected either directly across a battery rated at a terminal potential of 1.5 volts, or in series with the filaments of similar tubes across a power supply consisting of dry cells in series. In either case, the voltage across each 1.4-volt section of filament should not exceed 1.6 volts. With power-line or storage-battery supply, the filament may be operated in series with the filaments of similar tubes. For such operation, design adjustments should be made so that, with tubes of rated characteristics, operating with all electrode voltages applied and on a normal line voltage of 117 volts or on a normal storage-battery voltage of 2.0 volts per cell (without a charger) or 2.2 volts per cell (with a charger), the voltage drop across each 1.4-volt section of filament will be maintained within a range of 1.25 to 1.4 volts with a nominal center of 1.3 volts. In order to meet the recommended conditions for operating filaments in series from dry-battery, storage-battery, or power-line sources it may be necessary to use shunting resistors across the individual 1.4-volt sections of filament.

**B. 2.0-Volt Battery Tube Types**—The 2.0-volt line of tubes is designed to be operated with 2.0 volts across the filament. In all cases the operating voltage range should be maintained within the limits of 1.8 volts to 2.2 volts.

**2. POSITIVE POTENTIAL ELECTRODES**—The power sources for the operation of radio equipment are subject to variations in their terminal potential. Consequently, the maximum ratings shown on the tube-type data sheets have been established for certain Design Center Voltages which experience has shown to be representative. The Design Center Voltages to be used for the various power supplies together with other rating considerations are as given below:

**A. AC or DC Power Line Service in U.S.A.** The design center voltage for this type of power supply is 117 volts. The maximum ratings of plate voltages, screen-supply voltages, dissipations, and rectifier output currents are design maximums and should not be exceeded in equipment operated at a line voltage of 117 volts.

**B. Storage-Battery Service**—When storage-battery equipment is operated without a charger, it should be designed so that the published maximum values of plate voltages, screen-supply voltages, dissipations, and rectifier output currents are never exceeded for a terminal potential at the battery source of 2.0 volts per cell. When storage-battery equipment is operated with a charger, it should be designed so that 90% of the same maximum values is never exceeded for a terminal potential at the battery source of 2.2 volts.

**C. "B"-Battery Service**—The design center voltage for "B" batteries is the normal voltage rating of the battery block, such as 45 volts, 90 volts, etc. Equipment should be designed so that under no condition of battery voltage will the plate voltages, the screen-supply voltages, or dissipations ever exceed the recommended respective maximum values shown in the data for each tube type by more than 10%.

**D. Other Considerations**—

**a. Class A<sub>1</sub> Amplifiers**—The maximum plate dissipation occurs at the "Zero-Signal" condition. The maximum screen dissipation usually occurs at the condition where the peak-input signal voltage is equal to the bias voltage.

**b. Class B Amplifiers**—The maximum plate dissipation theoretically occurs at approximately 63% of the "Maximum-Signal" condition, but practically may occur at any signal voltage value.

**c. Converters**—The maximum plate dissipation occurs at the "Zero-Signal" condition and the frequency at which the oscillator-developed bias is a minimum. The screen dissipation for any reasonable variation in signal voltage must never exceed the rated value by more than 10%.

**d. Screen Ratings**—When the screen voltage is supplied through a series voltage-dropping resistor, the maximum screen voltage rating may be exceeded,

provided the maximum screen dissipation rating is not exceeded at any signal condition, and the maximum screen voltage rating is not exceeded at the maximum-signal condition. Provided these conditions are fulfilled, the screen-supply voltage may be as high as, but not above, the maximum plate voltage rating.

For certain voltage amplifier types, as listed in the data section, the maximum permissible screen (grid-No.2) input varies with the screen voltage, as shown in Fig. 82. Full rated screen input is permissible at screen voltages up to 50 per cent of the maximum rated screen supply voltage. As the voltage is increased from 50 per cent to 100 per cent of the maximum rated supply voltage, the decrease in permissible screen input follows a curve of the parabolic form. This rating chart is useful for applications utilizing either a fixed screen voltage or a series screen dropping resistor. When a fixed voltage is used, it is necessary only to determine that the screen input is within the boundary of the chart at the screen voltage to be used. When a dropping resistor is used, the value of the resistor must be large enough to maintain the screen input within the boundary of the chart. The minimum value of the series screen-voltage dropping resistor is given by the factor  $E_{cc2}^2 / 4 P_{g2}$ , where  $E_{cc2}$  is the selected screen supply voltage and  $P_{g2}$  is the maximum screen input rating for the type.

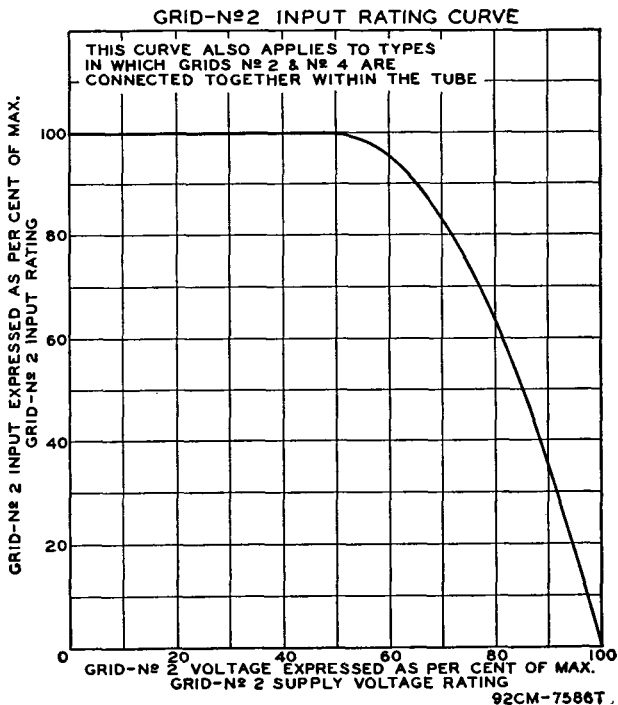
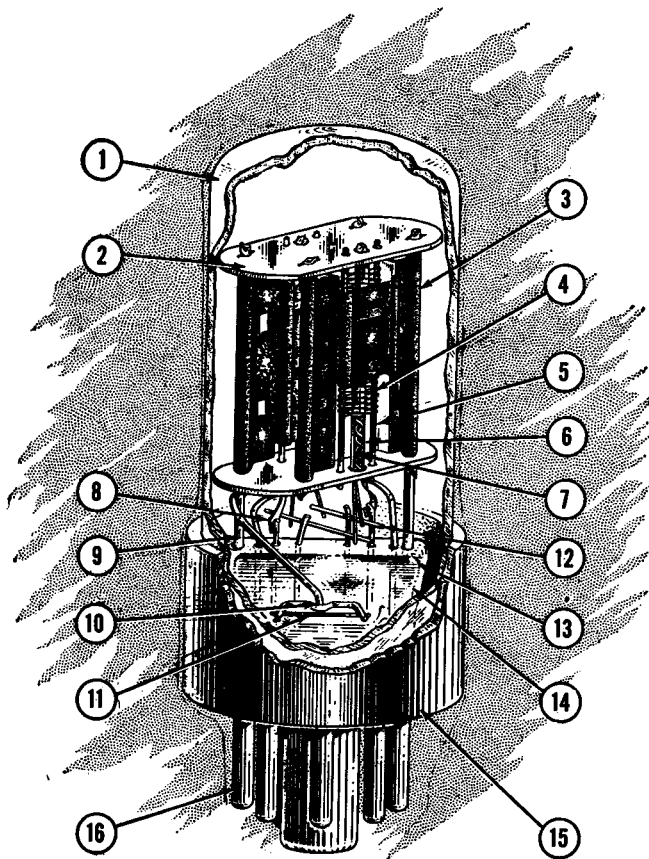

Fig. 82



## Tube-Part Materials in Typical RCA Electron Tube

- |  |  |
|--|--|
| 1. <b>ENVELOPE</b> —Lime glass   | 8. <b>CATHODE TAB</b> —Nickel                                    |
| 2. <b>SPACER</b> —Mica sprayed with magnesium oxide  | 9. <b>MOUNT SUPPORT</b> —Nickel or nickel-plated iron            |
| 3. <b>PLATE</b> —Carbonized nickel or nickel-plated steel                                  | 10. <b>GETTER SUPPORT AND LOOP</b> —Nickel or nickel-plated iron |
| 4. <b>GRID WIRES</b> —Manganese-nickel or molybdenum                                       | 11. <b>GETTER</b> —Barium-magnesium alloys                       |
| 5. <b>GRID SIDE-RODS</b> —Chrome copper, nickel, or nickel-plated iron                     | 12. <b>HEATER CONNECTOR</b> —Nickel or nickel-plated iron        |
| 6. <b>CATHODE</b> —Nickel coated with barium-calcium-strontium carbonates                  | 13. <b>STEM LEAD-IN WIRES</b> —Nickel, dumet, copper             |
| 7. <b>HEATER</b> —Tungsten or tungsten-molybdenum alloy with insulating coating of alundum | 14. <b>PRESSED STEM</b> —Lead glass                              |
|  | 15. <b>BASE</b> —Bakelite  |
|  | 16. <b>BASE PINS</b> —Nickel-plated brass                        |

# RCA Receiving Tube Classification Chart

RCA receiving tubes are classified in the following chart according to function and filament or heater voltage. Types having similar electrical characteristics are grouped in brackets. For more complete data on these types, refer to the TUBE TYPES SECTION. When choosing a tube type, refer to information on *Preferred Types* and the listing of *Types Not Recommended for New Equipment Design* on the inside back cover. For information on kinescopes, refer to the RCA KINESCOPE CHARACTERISTICS CHART on pages 246 and 247.

| Filament or Heater Volts   |                           | 1.25-1.4                       |                                     |                               | 2.0-5.0                                     |                | 6.3-117.0   |  |   |
|--|---------------------------|--------------------------------|-------------------------------------|-------------------------------|---|----------------|---|--|---|
|  |                           | Sub-miniature                  | Miniature                           | Other                         | Octal                                       | Other          | Miniature   | Octal  | Other   |
| <b>RECTIFIERS</b> (For rectifiers with amplifier units, see POWER AMPLIFIERS).                                       |                           |                                |                                     |                               |   |                |   |  |   |
| Half-Wave  | vacuum                    | Peak Inverse Volts: Below 1500 |                                     |                               |   |                | 35W4<br>11Z3  | 6AX4-GT 6W4-GT<br>12AX4-GT 25W4-GT<br>(5Z4-GT 35Z3-GT)   | 1-v<br>35Y4 35Z3  |
|  |                           | Above 1500                     |                                     | 1V2<br>(1X2-A)<br>(1X2-B)     | 1B3-GT                                      | 3A3            | 3A2   |  | 6AU4-GT   |
| Full-Wave  | vacuum                    | Peak Inverse Volts: Below 1500 |                                     |                               | (5Y3-G, 5Z4<br>5Y3-GT, 5Y4-G<br>5A2A<br>80) |                | (6X4<br>12X4)   | 6X5, 6X5-GT<br>6AX5-GT   | 7Y4<br>7Z4<br>84/6Z4  |
|  |                           | Above 1500                     |                                     |                               | (6V4-G, 5W4-GT<br>83-v)                     |                |   |  |   |
|  | mercury-vapor             | Above 1500                     |                                     |                               | (5T4, 5U4-G<br>5X4-G)                       | 5Z3            |   |  |   |
|  | gas                       | Below 1500                     |                                     |                               | Cold-Cathode<br>Types<br>0Z4, 0Z4-G         |                |   |  |   |
| Doubler  | vacuum                    | Peak Inverse Volts: Below 1500 |                                     |                               |   |                |   | (25Z6, 25Z6-GT<br>25Z5)  | 50X6  |
| <b>DIODE DETECTORS</b> (For diode detectors with amplifier units, see VOLTAGE AMPLIFIERS and also POWER AMPLIFIERS). |                           |                                |                                     |                               |   |                |   |  |   |
| One Diode  |                           |                                |                                     | 1A3                           |   |                |   |  |   |
| Two Diodes   |                           |                                |                                     |                               |   |                | 6AL5<br>12AL5   | (6H6, 6H6-GT)<br>12H6  | 7A6   |
| Three Diodes   |                           |                                |                                     |                               |   |                | 6BC7  |  |   |
| <b>POWER AMPLIFIERS with and without Rectifiers, Diode Detectors, and Voltage Amplifiers.</b>                        |                           |                                |                                     |                               |   |                |   |  |   |
| Triodes  | low- $\mu$                | single unit                    |                                     |                               |   | 2A3<br>45 71-A |   | 6B4-G  |   |
|  | high- $\mu$               | single unit                    |                                     |                               |   |                | 6BC4  | 6AC5-GT  |   |
|  |                           | twin unit                      |                                     |                               |   |                |   | 6AQ7-GT, (6N7, 6N7-GT)   |   |
| Beam Tubes   | single unit               |                                |                                     | (1Q5-GT)<br>(9Q5-GT)<br>3LF4* |   |                | 6AS5<br>6BF5<br>6AQ5<br>12AQ5<br>(35B5, 35C5)<br>(50B5, 50C5) | 6AU5-GT 6BG6-G (6L6)<br>6BQ6-GT 6CD6-G (6L6-G)<br>6V6 6V6-GT 6AV5-GT<br>12V6-GT 6Y6-G 25L6<br>19BQ6-G 6W6-GT (25L6-GT)<br>25BQ6-GT 50C6-G<br>50L6-GT 35L6-GT | 7A5<br>7C5 1AC3<br>35A5<br>50A5                                 |
|  | with rectifier            |                                |                                     |                               |   |                |   | (11Z7/MZ-GT)<br>11Z7-GT<br>70L7-GT<br>117N7-GT   | 7B5 7AD7  |
| Pentodes   | single unit               | IAC3                           | (1S4)<br>(35A4)<br>(30A4)<br>(3V4)* | 1A5-GT<br>1C5-GT<br>1LB4      |   | 47             | 6CL6<br>(6AK6)<br>6AR5  | 6AG7<br>6C6-G  | (6F6, 6F6-G, 6F6-GT)<br>(6K6-GT)<br>(25A6)<br>42)<br>41)<br>43) |
|  | with medium- $\mu$ triode |                                |                                     |                               |   |                |   | 6AD7-G   |   |
|  | with diode and triode     |                                |                                     | 1D8-GT                        |   |                |   |  |   |

# RCA Receiving Tube Manual

| Filament or Heater Volts   |                           | 1.25—1.4               |            |                        | 2.0—5.0                |       | 6.3—117.0                            |   |  |  |                               |
|--|---------------------------|------------------------|------------|------------------------|------------------------|-------|--------------------------------------|---|--|--|-------------------------------|
|  |                           | Sub-miniature          | Miniature  | Other                  | Octal                  | Other | Miniature                            | Octal   | Other  |  |                               |
| <b>CONVERTERS &amp; MIXERS</b> (For other types used as Mixers, see VOLTAGE AMPLIFIERS).                             |                           |                        |            |                        |                        |       |                                      |   |  |  |                               |
| Converters   | pentagrid                 | 1E8                    | 1L6<br>1R5 | 1A7-GT<br>1LA6<br>1LC6 |                        |       | 6BE6<br>12BA7<br>6BA7<br>6A8<br>6AT8 | 6SA7<br>6SA7-GT<br>12SA7<br>12SA7-GT<br>6SB7-Y                              | 6A8, 6A8-C<br>6A8-GT<br>6A7<br>7B8<br>7Q7                      | 14B8<br>14Q7                               |                               |
|  | triode-pentode            |                        |            |                        |                        |       |                                      | 12A8-GT   |  |  |                               |
|  | triode-hexode             |                        |            |                        |                        |       |                                      | 6K8, 12K8   |  |  |                               |
|  | triode-heptode            |                        |            |                        |                        |       |                                      | 6J8-G   |  | 7J7  |                               |
|  | octode                    |                        |            |                        |                        |       |                                      |   |  | 7A8  |                               |
| Mixers   | pentagrid                 |                        |            |                        |                        |       |                                      | 6L7   |  |  |                               |
| <b>ELECTRON-RAY TUBES</b>  |                           |                        |            |                        |                        |       |                                      |   |  |  |                               |
| Single   | with remote-cutoff triode |                        |            |                        |                        |       |                                      |   |  | 6AB5/6N5 6U5                               |                               |
|  | with sharp-cutoff triode  |                        |            |                        |                        |       |                                      |   |  | 6E5  |                               |
| Twin   | without triode            |                        |            |                        |                        |       |                                      | 6AF6-G  |  |  |                               |
| Triple   | without triode            |                        |            |                        |                        |       |                                      | 6AL7-GT   |  |  |                               |
| <b>VOLTAGE AMPLIFIERS with and without Diode Detectors;<br/>TRIODE, TETRODE, AND PENTODE DETECTORS; OSCILLATORS.</b> |                           |                        |            |                        |                        |       |                                      |   |  |  |                               |
| Triodes  | medium- $\mu$             | single unit            |            |                        | 1LE3                   | 27    | 6AF4<br>6C4 6S4                      | 6C5, 6C5-CT<br>6J5, 6J5-GT 12J5-GT<br>6AH4-GT                               |  | 7A4  |                               |
|  |                           | with if pentode        |            |                        |                        |       |                                      |   | 6F7  |  |                               |
|  |                           | with power pentode     |            |                        |                        |       |                                      |   |  | 6AD7-G                                     |                               |
|  |                           | with pentode and diode |            |                        | 1D8-GT                 |       |                                      |   |  |  |                               |
|  |                           | with two diodes        |            |                        |                        |       |                                      | 6BF6<br>12BF6   | 6R7<br>6SR7 6ST7<br>12SR7                                      |  |                               |
|  | twin unit                 |                        |            |                        |                        |       | 6BK7-A 6J6<br>6BQ7-A 19J6<br>6BZ7    | 12AU7* 12AV7*<br>12BH7* 12BH7*  | 6F8-G, 6SN7-GT, 6SN7-CTA<br>6C8-G 12AH7-GT<br>6BL7-GT 12SN7-GT | 7AF7 14AF7<br>7F8 14F8<br>7N7              |                               |
|  | high- $\mu$               | single unit            |            |                        |                        |       |                                      | 6AB4  | 6F5, 6F5-CT<br>6SF5, 6SF5-GT<br>12SF5                          |  | 7B4                           |
|  |                           | with diode             |            |                        | 1H5-CT<br>1LH4         |       |                                      |   |  |  |                               |
|  |                           | with two diodes        |            |                        |                        |       |                                      | 12AT6 12AV6<br>6AT6 6AV6  | 6Q7<br>6Q7-GT, 6SZ7<br>6SQ7, 6SQ7-GT                           | 12Q7-GT<br>12SQ7<br>12SQ7-GT               | 7B6 14B6<br>7C6 75<br>7K7 7X7 |
|  |                           | with three diodes      |            |                        |                        |       |                                      | 6T8 19T8  |  | 6S8-GT                                     |                               |
| twin unit  |                           |                        |            |                        |                        |       | 12AT7*<br>12AX7*                     | 6SC7, 12SC7<br>6SL7-GT 12SL7-GT   |  | 7F7 14F7                                   |                               |
| Tetrodes   | sharp-cutoff              |                        |            |                        | 24-A                   |       |                                      |   |  |  |                               |
| Pentodes   | remote-cutoff             | single unit            |            | 1T4                    | 1LG5                   |       | 6BJ6 (6BD6)<br>12BD6<br>6BA6 (12BA6) | 6SK7, 6SK7-GT<br>12SK7, 12SK7-GT<br>6S7 6S7                                 | 6K7-C<br>6K7-GT<br>12K7-GT<br>6S7 6S7                          | 7B 7A7 14A7<br>6D6<br>7H7 14H7<br>7AH7 7B7 |                               |
|  |                           | with triode            |            |                        |                        |       |                                      |   |  | 6F7  |                               |
|  |                           | with diode             |            |                        |                        |       |                                      |   | 6SF7 12SF7   |  |                               |
|  |                           | with two diodes        |            |                        |                        |       |                                      |   | 12C8<br>6B8  |  | 7E7<br>14R7                   |
|  | semiremote-cutoff         | single unit            |            |                        |                        |       | 6DC6                                 |   |  |  |                               |
|  | sharp-cutoff              | single unit            | 1AD5       | 1L4<br>1U4             | 1LC5<br>1LN5<br>1NS-CT |       |                                      | 6AG5 6AK5<br>6BC5 6CB6<br>6CF6<br>6AF6 6BH6<br>12AW6 (6AU6<br>12BY7* (12AU6 | 6SJ7 (6SJ7-GT)<br>12SJ7<br>6AC7<br>12J7-GT                     | 7AG7 7G7<br>7C7 14C7<br>7L7 7V7            |                               |
|  |                           | with triode            |            |                        |                        |       |                                      | 6AN8  | 6SH7<br>12SH7  | 6J7, 6J7-CT<br>6W7-G                       | 6C6<br>77<br>7W7              |
| with diode   |                           | 1T6                    | 1S5 1U5    | 1LD5                   |                        |       | 6AS8                                 |   |  |  |                               |
| <b>GATED AMPLIFIERS</b>  |                           |                        |            |                        |                        |       |                                      |   |  |  |                               |
| Pentagrid Amplifier  |                           |                        |            |                        |                        |       | 6BY6                                 |   |  |  |                               |
| <b>SHUNT VOLTAGE REGULATORS</b>  |                           |                        |            |                        |                        |       |                                      |   |  |  |                               |
| Beam Triode  |                           |                        |            |                        |                        |       |                                      | 6BD4-A  |  |  |                               |

\* Filament arranged for either 1.4 or 2.8-volt operation. \* Heater arranged for either 6.3 or 12.6-volt operation.

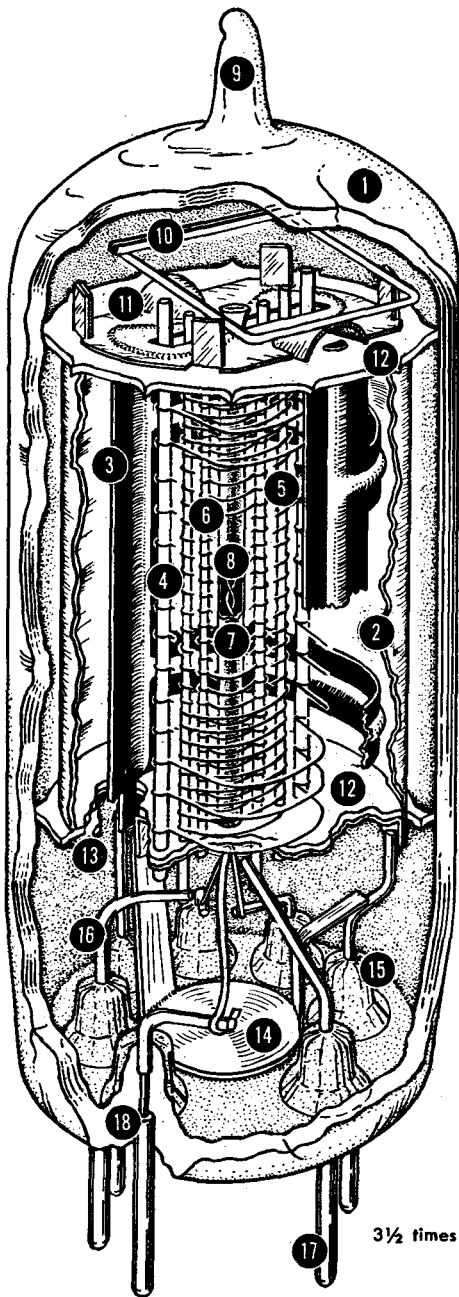

- 1—Glass Envelope
- 2—Internal Shield
- 3—Plate
- 4—Grid No. 3 (Suppressor)
- 5—Grid No. 2 (Screen)
- 6—Grid No. 1 (Control Grid)
- 7—Cathode
- 8—Heater
- 9—Exhaust Tip
- 10—Getter
- 11—Spacer Shield Header
- 12—Insulating Spacer
- 13—Spacer Shield
- 14—Inter-Pin Shield
- 15—Glass Button-Stem Seal
- 16—Lead Wire
- 17—Base Pin
- 18—Glass-to-Metal Seal

3½ times actual size

## Structure of a Miniature Tube

# RCA Tube Types

This section contains technical descriptions of RCA tubes used in standard broadcast, FM, and television receivers. It includes data on current types, as well as information on those RCA discontinued types in which there may still be some interest as to characteristics.

In choosing tube types for the design of new electronic equipment, the designer is referred to the inside back cover for information regarding the availability of the latest **RCA Preferred Types List** and for a listing of **RCA Tube Types Not Recommended for New Equipment Design**.

Tube types are listed in this section according to the numerical-alphabetical sequence of their type designations. For **Key to Socket Connection Diagrams**, see inside front cover.

## DETECTOR AMPLIFIER TRIODE

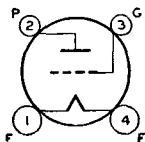

Storage-battery triode used as detector or amplifier. Outline 38, **OUTLINES SECTION**. Operating conditions as grid-resistor detector are: plate volts, 45 *max*; grid resistor, 2 to 3 megohms; grid capacitor, 250  $\mu\text{f}$ ; grid return to (+) filament. As biased detector, type 01-A has plate volts of 135 *max*; bias of approximately -13.5 volts. As amplifier, it has plate volts of 135 *max*; bias of -9 volts. Filament volts, 5; amperes, 0.25. This is a **DISCONTINUED** type listed for reference only.

**01-A**

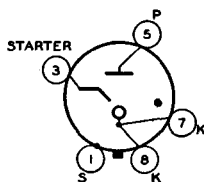

## HALF-WAVE GAS RECTIFIER

Metal type used primarily in vibrator-type B-supply units of automobile receivers. Utilizes a starter electrode and an ionically heated cathode. Starter anode permits operation of OY4 directly from 117-volt ac line. Outline 3, **OUTLINES SECTION**. Tube requires octal socket. Pins 7 and 8 must be tied together at socket. RF filter circuits placed close to socket terminals are required to reduce rectifier noise. Ratings as

**OY4**

half-wave rectifier with capacitor-input filter: peak inverse anode volts, 300 *max*; peak anode ma., 500 *max*; dc output ma., 75 *max*, 40 *min*; series anode resistance (117-volt line operation), 50 *min* ohms; tube voltage drop (approx.), 12 volts; minimum ac starting voltage when starter anode is connected to anode through a 10-megohm resistor bypassed with a 0.002- $\mu\text{f}$  capacitor, 100 volts rms. This is a **DISCONTINUED** type listed for reference only.

## FULL-WAVE GAS RECTIFIER

Metal type OZ4 and glass octal type OZ4-G are used in vibrator-type B-supply units. Both have ionically heated cathodes, require octal sockets, and may be mounted in any position. OZ4 Outline 2, **OUTLINES SECTION**. OZ4-G dimensions: maximum overall length, 2-5/8 inches; maximum diameter, 1-1/16 inches; T-7 bulb; dwarf-shell octal 5-pin base. Base of OZ4-G has no pin No. 2. Shell of OZ4 and external shield of OZ4-G should be grounded. Filters may be necessary to eliminate objectionable noise.

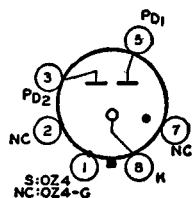

**OZ4**  
**OZ4-G**

**FULL-WAVE RECTIFIER**

**Maximum Ratings:**

|   |          |       |
|---|----------|-------|
| PEAK STARTING SUPPLY VOLTAGE PER PLATE..... | 300 min  | volts |
| PEAK PLATE-TO-PLATE VOLTAGE.....            | 1000 max | volts |
| PEAK PLATE CURRENT PER PLATE.....           | 200 max  | ma    |
|   | { 75 max | ma    |
|   | { 30 min | ma    |
| DC OUTPUT CURRENT.....                      | 300 max  | volts |
| DC OUTPUT VOLTAGE.....                      | 24       | volts |
| AVERAGE DYNAMIC TUBE VOLTAGE DROP.....      |          |       |

# 1A3

**HF DIODE**

Miniature type used as detector tube in portable FM receivers and in portable high-frequency measuring equipment. Outline 13, OUTLINES SECTION. Tube requires miniature seven-contact socket. Heater volts (ac/dc), 1.4; amperes, 0.15.

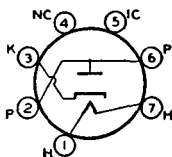

**Maximum Ratings:**

**HALF-WAVE RECTIFIER**

|                                  |         |       |
|----------------------------------|---------|-------|
| PEAK INVERSE PLATE VOLTAGE.....  | 330 max | volts |
| PEAK PLATE CURRENT.....          | 5 max   | ma    |
| DC OUTPUT CURRENT.....           | 0.5 max | ma    |
| PEAK HEATER-CATHODE VOLTAGE..... | 140 max | volts |

**Typical Operation (With Capacitor-Input Filter):**

|   |     |       |
|---|-----|-------|
| AC Plate-Supply Voltage (rms).....                  | 117 | volts |
| Filter-Input Capacitor.....                         | 2   | μf    |
| Minimum Total Effective Plate-Supply Impedance..... | 0   | ohms  |

**REMOTE-CUTOFF PENTODE**

Glass type used in battery-operated receivers as rf or if amplifier. For ratings and operating data, refer to type 1D5-GP. Outline 36, OUTLINES SECTION. Tube requires four-contact socket. Filament volts (dc), 2.0; amperes, 0.06. This is a DISCONTINUED type listed for reference only.

# 1A4-P

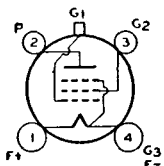

**POWER PENTODE**

Glass octal type used in output stage of battery-operated receivers. Outline 23, OUTLINES SECTION. This type may be supplied with pin No.1 omitted. Tube requires octal socket and may be mounted in any position. For filament considerations, refer to 1U4. Filament volts (dc), 1.4; amperes, 0.05. Typical operation as class A<sub>1</sub> amplifier: plate and grid-No.2 volts, 90 (110 max); grid-No.1 volts, -4.5; peak af grid-No.1 volts, 4.5; plate ma., 4.0; grid-No.2 ma., 1.1; plate resistance (approx.), 0.3 megohm; transconductance, 850 μmhos; load resistance, 25000 ohms; power output, 115 milliwatts. This type is used principally for renewal purposes.

# 1A5-GT

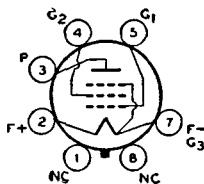

**PENTAGRID CONVERTER**

Glass type used in battery-operated receivers. Type 1A6 is identical electrically with type 1D7-G, except for interelectrode capacitances. Outline 36, OUTLINES SECTION. Tube requires six-contact socket. Filament volts (dc), 2.0; amperes, 0.06. This is a DISCONTINUED type listed for reference only.

# 1A6

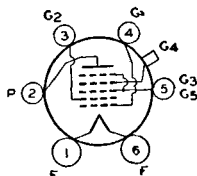



### PENTAGRID CONVERTER

Glass octal type used in superheterodyne circuits having battery power supplies. Outline 24, OUTLINES SECTION. Tube requires octal socket and may be mounted in any position. For filament considerations, refer to 1U4.

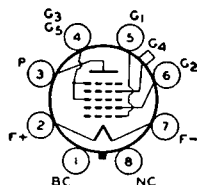

## 1A7-GT

|                            |      |        |
|----------------------------|------|--------|
| FILAMENT VOLTAGE (DC)..... | 1.4  | volts  |
| FILAMENT CURRENT .....     | 0.05 | ampere |

#### CONVERTER SERVICE

##### Maximum Ratings:

|   |                |       |
|---|----------------|-------|
| PLATE VOLTAGE.....                        | 110 <i>max</i> | volts |
| GRIDS-NO.3-AND-NO.5 (SCREEN) VOLTAGE..... | 60 <i>max</i>  | volts |
| GRIDS-NO.3-AND-NO.5 SUPPLY VOLTAGE.....   | 110 <i>max</i> | volts |
| GRID-NO.2 (ANODE-GRID) VOLTAGE.....       | 110 <i>max</i> | volts |
| TOTAL ZERO-SIGNAL CATHODE CURRENT.....    | 4 <i>max</i>   | ma    |

##### Typical Operation:

|  |       |        |
|--|-------|--------|
| Plate Voltage.....   | 90    | volts  |
| Grids-No.3-and-No.5 Voltage*.....  | 45    | volts  |
| Grid-No.2 Voltage.....   | 90    | volts  |
| Grid-No.4 (Control-Grid) Voltage**.....                                    | 0     | volts  |
| Grid-No.1 (Oscillator-Grid) Resistor.....                                  | 0.2   | megohm |
| Plate Resistance.....  | 0.6   | megohm |
| Conversion Transconductance.....   | 250   | μmhos  |
| Conversion Transconductance with grid-No.4 bias of -3 volts (Approx.)..... | 20    | μmhos  |
| Plate Current.....   | 0.6   | ma     |
| Grids-No.3-and-No.5 Current.....   | 0.7   | ma     |
| Grid-No.2 Current.....   | 1.2   | ma     |
| Grid-No.1 Current.....   | 0.035 | ma     |
| Total Cathode Current.....   | 2.5   | ma     |

\*Obtained preferably by using a bypassed 45000- to 75000-ohm voltage-dropping resistor in series with the 90-volt supply.

\*\* A resistance of at least 1.0 megohm should be in the grid return to negative filament pin.

### POWER PENTODE

Subminiature type used in output stage of small, compact, battery-operated receivers for the standard AM broadcast band. It is capable of moderate power output with a very small input

## 1A7-GT

voltage. The 1A7-GT and the other RCA subminiature types 1A5, 1E8, and 1T6 comprise a complete tube complement for lightweight portable radio receivers having extremely low battery drain.

|                            |      |        |
|----------------------------|------|--------|
| FILAMENT VOLTAGE (DC)..... | 1.25 | volts  |
| FILAMENT CURRENT.....      | 0.04 | ampere |

##### Maximum Ratings:

|                                 |                 |       |
|---------------------------------|-----------------|-------|
| PLATE VOLTAGE.....              | 67.5 <i>max</i> | volts |
| GRID-NO.2 (SCREEN) VOLTAGE..... | 67.5 <i>max</i> | volts |
| TOTAL CATHODE CURRENT.....      | 4.0 <i>max</i>  | ma    |

#### CLASS A<sub>1</sub> AMPLIFIER

##### Typical Operation:

|                                       |       |       |       |          |
|---------------------------------------|-------|-------|-------|----------|
| Plate Voltage.....                    | 30    | 45    | 67.5  | volts    |
| Grid-No.2 Voltage.....                | 30    | 45    | 67.5  | volts    |
| Grid-No.1 (Control-Grid) Voltage..... | -2    | -3    | -4.5  | volts    |
| Peak AF Grid-No.1 Voltage.....        | 2     | 3     | 4.5   | volts    |
| Zero-Signal Plate Current.....        | 0.5   | 1.0   | 2.0   | ma       |
| Zero-Signal Grid-No.2 Current.....    | 0.1   | 0.2   | 0.4   | ma       |
| Plate Resistance.....                 | 0.2   | 0.17  | 0.15  | megohm   |
| Transconductance.....                 | 450   | 600   | 750   | μmhos    |
| Load Resistance.....                  | 50000 | 40000 | 25000 | ohms     |
| Total Harmonic Distortion.....        | 10    | 10    | 10    | per cent |
| Maximum-Signal Power Output.....      | 5     | 15    | 50    | mw       |

**INSTALLATION AND APPLICATION**

Type 1AC5 requires a subminiature eight-contact socket and may be mounted in any position. Do not attempt to solder the base pins to any circuit element because the heat of the soldering operation may crack the glass seal. Although the base pins are sturdy, they can be bent. It is essential, therefore, that the pins be straight before they are inserted into the socket. Insertion will be facilitated if pins 1 and 8 are first aligned with their respective socket holes and the tube then gently pressed into the socket. Outline 8, OUTLINES SECTION.

The filament of the 1AC5 may be connected directly across a dry-cell battery rated at a terminal potential of 1.5 volts. In no case should the voltage across the filament ever exceed 1.6 volts. For additional filament considerations, refer to ELECTRON TUBE INSTALLATION SECTION.

**SHARP-CUTOFF PENTODE**

**1AD5**

Subminiature type used as rf or if amplifier in stages not controlled by avc in small, compact, battery-operated receivers for the standard AM broadcast band. Because of internal shielding

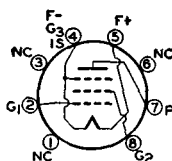

feature, an external bulb shield is not needed, but socket shielding is essential if minimum grid-No.1-to-plate capacitance is to be obtained. The 1AD5 and the other RCA subminiature types 1AC5, 1E8, and 1T6 comprise a complete tube complement for lightweight portable radio receivers having extremely low battery drain. Outline 8, OUTLINES SECTION. Tube requires subminiature eight-contact socket and may be mounted in any position. For installation and application considerations, refer to type 1AC5.

|                             |      |        |
|-----------------------------|------|--------|
| FILAMENT VOLTAGE (DC) ..... | 1.25 | volts  |
| FILAMENT CURRENT .....      | 0.04 | ampere |

**DIRECT INTERELECTRODE CAPACITANCES:**

|  |           |    |
|--|-----------|----|
| Grid No.1 to Plate .....   | 0.010 max | μf |
| Grid No.1 to Filament, Grid No.2, Grid No.3, and Internal Shield ..... | 1.8       | μf |
| Plate to Filament, Grid No.2, Grid No.3, and Internal Shield .....     | 2.8       | μf |

**Maximum Ratings:**

**CLASS A<sub>1</sub> AMPLIFIER**

|                                  |          |       |
|----------------------------------|----------|-------|
| PLATE VOLTAGE .....              | 67.5 max | volts |
| GRID-NO.2 (SCREEN) VOLTAGE ..... | 67.5 max | volts |
| TOTAL CATHODE CURRENT .....      | 4.0 max  | ma    |

**Typical Operation:**

|   |      |      |      |        |
|---|------|------|------|--------|
| Plate Voltage .....                                       | 30   | 45   | 67.5 | volts  |
| Grid-No.2 Voltage .....                                   | 30   | 45   | 67.5 | volts  |
| Grid-No.1 (Control-Grid) Voltage .....                    | 0    | 0    | 0    | volts  |
| Plate Resistance (Approx.) .....                          | 0.7  | 0.7  | 0.7  | megohm |
| Transconductance .....                                    | 430  | 580  | 785  | μmhos  |
| Grid-No.1 Bias (Approx.) for plate current of 10 μa ..... | -3   | -4   | -6   | volts  |
| Plate Current .....                                       | 0.45 | 0.9  | 1.85 | ma     |
| Grid-No.2 Current .....                                   | 0.16 | 0.35 | 0.75 | ma     |

**HALF-WAVE VACUUM RECTIFIER**

**1B3-GT**

Glass octal type used in high-voltage, low-current applications such as the rectifier in a high-voltage, rf-operated power supply or as a rectifier of high-voltage pulses produced in television

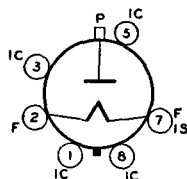

scanning systems. When used as an rf rectifier, one 1B3-GT in a half-wave circuit is capable of delivering a maximum dc output voltage of about 15000 volts. In a voltage-doubler circuit, two tubes will give about 30000 volts; and in a voltage-tripler circuit, three 1B3-GT's will deliver 45000 volts approximately. For curve of average plate characteristics, see page 61.

|                                    |      |                  |
|------------------------------------|------|------------------|
| FILAMENT VOLTAGE (AC).....         | 1.25 | volts            |
| FILAMENT CURRENT.....              | 0.2  | ampere           |
| DIRECT INTERELECTRODE CAPACITANCE: |      |                  |
| Plate to Filament (Approx.).....   | 1.5  | $\mu\mu\text{f}$ |

### Maximum Ratings:

### HALF-WAVE RECTIFIER

|                                  |                  |       |
|----------------------------------|------------------|-------|
| PEAK INVERSE PLATE VOLTAGE.....  | 30000 <i>max</i> | volts |
| PEAK PLATE CURRENT.....          | 17 <i>max</i>    | ma    |
| AVERAGE PLATE CURRENT.....       | 2 <i>max</i>     | ma    |
| FREQUENCY OF SUPPLY VOLTAGE..... | 300 <i>max</i>   | Kc    |

## INSTALLATION AND APPLICATION

Type 1B3-GT requires an octal socket and may be mounted in any position. Plate connection is cap at top of bulb. Internal connections are made to pins 1, 3, 5, and 8. These pins may be connected to pin 7; otherwise they should not be used. This type may be supplied with pin No. 1 omitted. Outline 30, OUTLINES SECTION.

The high voltages at which the 1B3-GT is operated are very dangerous. Great care should be taken to prevent coming in contact with these high voltages. In those circuits where the filament circuit is not grounded, the filament circuit operates at dc potentials which can cause fatal shock. Extreme precautions must be taken when the filament voltage is measured. These precautions must include safeguards which definitely eliminate all hazards to personnel. The filament transformer, whether it is of the iron-core or the air-core type, must be sufficiently insulated.

When used in television receivers and other equipment operating at 16000 volts or above, the 1B3-GT will produce X-rays which can constitute a health hazard unless the tube is adequately shielded.

### SHARP-CUTOFF PENTODE

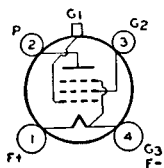

Glass type used as rf amplifier or detector in battery-operated receivers. Outline 36, OUTLINES SECTION. Tube requires four-contact socket. For typical operating conditions and maximum ratings as a class A<sub>1</sub> amplifier, refer to type 1E5-GP. Filament volts (dc), 2.0; amperes, 0.06. Type 1B4-P is a DISCONTINUED type listed for reference only.

## 1B4-P

### TWIN DIODE—MEDIUM-MU TRIODE

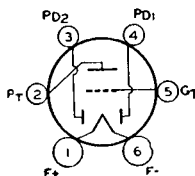

Glass type used as combined detector, amplifier, and avc tube in battery-operated receivers. Outline 31 or 34, OUTLINES SECTION. Tube requires six-contact socket. Filament volts (dc), 2.0; amperes, 0.06. Typical operation as class A<sub>1</sub> amplifier: plate volts, 135 *max*; grid volts, -3; plate ma., 0.8; plate resistance, 35000 ohms; amplification factor, 20; transconductance, 575  $\mu\text{mos}$ . This is a DISCONTINUED type listed for reference only.

## 1B5/25S

### PENTAGRID CONVERTER

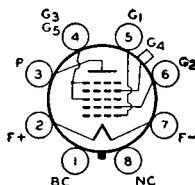

Glass octal type used in superheterodyne circuits having battery power supply. Outline 24, OUTLINES SECTION. Filament volts (dc), 1.4; amperes, 0.1. This is a DISCONTINUED type listed for reference only. The 1B7-GT may be replaced by the 1A7-GT if circuit adjustment is made for lower filament current of type 1A7-GT.

## 1B7-GT

**POWER PENTODE**

Glass octal type used in output stage of battery-operated receivers. Outline 23, OUTLINES SECTION. This type may be supplied with pin No.1 omitted. Tube requires octal socket and may be mounted in any position. For filament considerations, refer to 1U4. Filament volts (dc), 1.4; amperes, 0.1. Typical operation as class A<sub>1</sub> amplifier: plate and grid-No.2 volts, 90 (110 max); grid-No.1 volts, -7.5; peak

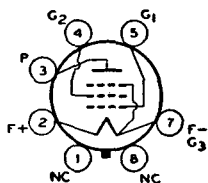

**1C5-GT**

af grid-No.1 volts, 7.5; plate ma., 7.8; grid-No.2 ma., 3.5; plate resistance (approx.), 115000 ohms; transconductance, 1550  $\mu$ mhos; load resistance, 8000 ohms; power output, 240 milliwatts. Type 1C5-GT is used principally for renewal purposes.

**PENTAGRID CONVERTER**

Glass type used in battery-operated receivers. Similar electrically to type 1C7-G except for interelectrode capacitances. Outline 36, OUTLINES SECTION. Tube requires six-contact socket. Filament volts (dc), 2.0; amperes, 0.12. For general discussion of pentagrid types, refer to *Frequency Conversion* in ELECTRON TUBE APPLICATIONS SECTION. This is a DISCONTINUED type listed for reference only.

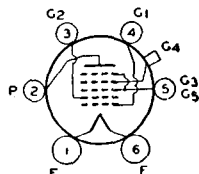

**1C6**

**PENTAGRID CONVERTER**

Glass octal type used in battery-operated receivers. Outline 35, OUTLINES SECTION. Tube requires octal socket. Filament volts (dc), 2.0; amperes, 0.12. Typical operation as converter: plate volts, 180 max; grids-No.3-and-No.5 (screen) volts, 67.5 max; grid-No.2 (anode grid) supply volts, 180 (applied through 20000-ohm dropping resistor bypassed by 0.01- $\mu$ f capacitor); grid-No.4 (control-grid) volts, -3;

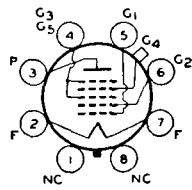

**1C7-G**

grid-No.1 (oscillator-grid) resistor, 50000 ohms; plate ma., 1.5; grids-No.3-and-No.5 ma., 2; grid-No.2 ma., 4; grid-No.1 ma., 0.2. This is a DISCONTINUED type listed for reference only.

**REMOTE-CUTOFF PENTODE**

Glass octal type used in battery-operated receivers as rf or if amplifier. Outline 35, OUTLINES SECTION. Tube requires octal socket. Filament volts (dc), 2.0; amperes, 0.06. Typical operation as class A<sub>1</sub> amplifier: plate volts, 180 max; grid-No.2 (screen) volts, 67.5 max; grid-No.1 volts, -3 min; plate ma., 2.3; grid-No.2 ma., 0.8; plate resistance (approx.), 1.0 megohm; transconductance, 750  $\mu$ mhos; transconductance at bias of -15 volts, 15  $\mu$ mhos. This is a DISCONTINUED type listed for reference only.

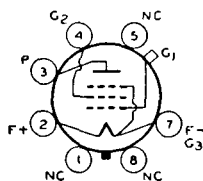

**1D5-GP**

**REMOTE-CUTOFF TETRODE**

Glass octal type used in battery-operated receivers as rf or if amplifier. Outline 35, OUTLINES SECTION. Filament volts (dc), 2.0; amperes, 0.06. This is a DISCONTINUED type listed for reference only. It can be replaced by type 1D5-GP.

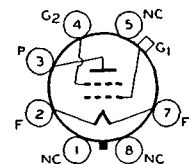

**1D5-GT**

**PENTAGRID CONVERTER**

Glass octal type used in battery-operated receivers. Outline 35, OUTLINES SECTION. Tube requires octal socket. Filament volts (dc), 2.0; amperes, 0.06. Typical operation as converter: plate volts, grids-No.3-and-No.5 volts, grid-No.2 supply volts, grid-No.4 volts, and grid-No.1 resistor are same as for type 1C7-G; plate ma., 1.3; grids-No.3-and-No.5 ma., 2.4; grid-No.2 ma., 2.3; grid-No.1 ma., 0.2. This is a DISCONTINUED type listed for reference only.

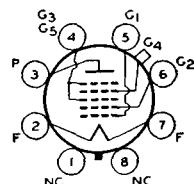

**1D7-G**

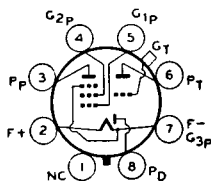

**DIODE—TRIODE—POWER PENTODE**

Glass octal type used in compact battery-operated receivers. Diode unit is used as detector or avc tube, triode as first audio amplifier, and pentode as power output tube. Outline 21, OUTLINES SECTION. Tube requires octal socket. Filament volts (dc), 1.4; amperes, 0.1. Maximum plate volts of triode as well as maximum plate and grid-No.2 volts of pentode, 110. This type is used principally for renewal purposes.

**1D8-GT**

**Typical Operation (Pentode Unit): CLASS A<sub>1</sub> AMPLIFIER**

|                                  |       |       |       |            |
|----------------------------------|-------|-------|-------|------------|
| Plate Voltage                    | 45    | 67.5  | 90    | volts      |
| Grid-No.2 (Screen) Voltage       | 45    | 67.5  | 90    | volts      |
| Grid-No.1 (Control-Grid) Voltage | -4.5  | -6    | -9    | volts      |
| Plate Current                    | 1.6   | 3.8   | 5     | ma         |
| Grid-No.2 Current                | 0.3   | 0.8   | 1.0   | ma         |
| Transconductance                 | 650   | 875   | 925   | $\mu$ mhos |
| Load Resistance                  | 20000 | 16000 | 12000 | ohms       |
| Total Harmonic Distortion        | 10    | 10    | 10    | per cent   |
| Power Output                     | 35    | 100   | 200   | mw         |

**Typical Operation (Triode Unit):**

|                            |       |       |       |            |
|----------------------------|-------|-------|-------|------------|
| Plate Voltage              | 45    | 67.5  | 90    | volts      |
| Grid Voltage               | 0     | 0     | 0     | volts      |
| Amplification Factor       | 25    | 25    | 25    |            |
| Plate Resistance (Approx.) | 77000 | 55500 | 43500 | ohms       |
| Transconductance           | 325   | 450   | 575   | $\mu$ mhos |
| Plate Current              | 0.3   | 0.6   | 1.1   | ma         |

**SHARP-CUTOFF PENTODE**

Glass octal type used as rf amplifier or detector in battery-operated receivers. Outline 35, OUTLINES SECTION. Tube requires octal socket. Filament volts (dc), 2.0; amperes, 0.06. Typical operation as class A<sub>1</sub> amplifier: plate volts, 180 max; grid-No.2 (screen) volts, 67.5 max; grid-No.1 volts, -3; plate ma., 1.7; grid-No.2 ma., 0.6; plate resistance, 1.5 megohms; transconductance, 650  $\mu$ mhos; grid volts for

**1E5-GP**

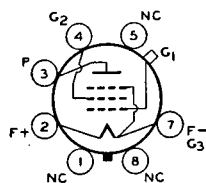
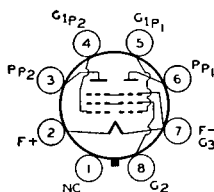

plate-current cutoff (approx.), -8. This is a DISCONTINUED type listed for reference only.

**TWIN POWER PENTODE**

Glass octal type used in push-pull output stage of battery-operated receivers. Outline 23, OUTLINES SECTION. Tube requires octal socket. Filament volts (dc), 2.0; amperes, 0.24. Typical operation as push-pull class A<sub>1</sub> amplifier: plate and grid-No.2 volts, 135 max; grid-No.1 volts, -7.5; plate ma., 10.5; grid-No.2 ma., 3.5; output watts, 0.575. The two units are used in the same manner as two separate tubes in

**1E7-GT**



conventional push-pull audio-frequency amplifier circuits. This is a DISCONTINUED type listed for reference only.

**PENTAGRID CONVERTER**

Subminiature type used in small, compact, battery-operated receivers for the standard AM broadcast band. The 1E8 and the other RCA subminiature types 1AC5, 1AD5, and 1T6

**1E8**

comprise a complete tube complement for lightweight portable radio receivers having extremely low battery drain. Outline 8, OUTLINES SECTION. Tube requires subminiature eight-contact socket and may be mounted in any position. For general discussion of pentagrid types, see *Frequency Conversion* in ELEC-TRON TUBE APPLICATIONS SECTION. For installation and application considerations, refer to type 1AC5.

|   |                |               |
|---|----------------|---------------|
| FILAMENT VOLTAGE (DC).....                                | 1.25           | volts         |
| FILAMENT CURRENT.....                                     | 0.04           | ampere        |
| <b>DIRECT INTERELECTRODE CAPACITANCES:</b>                |                |               |
| Grid No.3 to All Other Electrodes (RF Input).....         | 6.0            | $\mu\text{f}$ |
| Plate to All Other Electrodes (Mixer Output).....         | 5.0            | $\mu\text{f}$ |
| Grid No.1 to All Other Electrodes (Oscillator Input)..... | 2.4            | $\mu\text{f}$ |
| Grid No.3 to Plate.....                                   | 0.4 <i>max</i> | $\mu\text{f}$ |
| Grid No.3 to Grid No.1.....                               | 0.2 <i>max</i> | $\mu\text{f}$ |

### CONVERTER SERVICE

|   |                 |       |
|---|-----------------|-------|
| Maximum Ratings:                          |                 |       |
| PLATE VOLTAGE.....                        | 67.5 <i>max</i> | volts |
| GRIDS-NO.2 AND NO.4 (SCREEN) VOLTAGE..... | 45 <i>max</i>   | volts |
| GRIDS-NO.2 AND NO.4 SUPPLY VOLTAGE.....   | 67.5 <i>max</i> | volts |
| TOTAL CATHODE CURRENT.....                | 4.0 <i>max</i>  | ma    |

### Characteristics (Separate Excitation): #

|  |       |       |       |                  |
|--|-------|-------|-------|------------------|
| Plate Voltage.....   | 30    | 45    | 67.5  | volts            |
| Grids-No.2 and No.4 Supply Voltage.....  | 30    | 45    | 67.5  | volts            |
| Grids-No.2 and No.4 Resistor.....  | 10000 | 15000 | 20000 | ohms             |
| Grid-No.3 (Control-Grid) Voltage.....  | 0     | 0     | 0     | volts            |
| Grid-No.1 (Oscillator-Grid) Resistor.....  | 0.1   | 0.1   | 0.1   | megohm           |
| Plate Resistance (Approx.).....  | 0.3   | 0.4   | 0.4   | megohm           |
| Conversion Transconductance.....   | 115   | 140   | 150   | $\mu\text{mhos}$ |
| Grid-No.3 Voltage for Conversion Transconductance of 5 $\mu\text{mhos}$ (Approx.)..... | -7    | -8    | -9    | volts            |
| Plate Current.....   | 0.3   | 0.6   | 1.0   | ma               |
| Grids-No.2 and No.4 Current.....   | 0.8   | 1.1   | 1.5   | ma               |
| Grid-No.1 Current.....   | 30    | 50    | 70    | $\mu\text{a}$    |
| Total Cathode Current.....   | 1.1   | 1.7   | 2.5   | ma               |

NOTE: The transconductance between grid No.1 and grids No.2 and No.4 connected to plate (not oscillating) is approximately 730  $\mu\text{mhos}$  under the following conditions: signal applied to grid No.1 at zero bias; grids No.2 and No.4 and plate at 30 volts; and grid-No.3 grounded. Under the same conditions, the total cathode current is 3 milliamperes and the amplification factor is 3.9.

# The characteristics shown under separate excitation approximate those obtained in a self-excited oscillator operating with zero bias.

### POWER PENTODE

## 1F4

Glass type used in output stage of battery-operated receivers. Outline 38, OUTLINES SECTION. Tube requires five-contact socket. Filament volts (dc), 2.0; amperes, 0.12. Type 1F4 is similar electrically to type 1F5-G. Type 1F4 is a DISCONTINUED type listed for reference only.

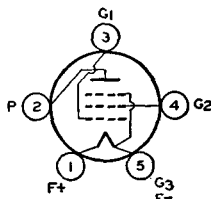

### POWER PENTODE

## 1F5-G

Glass octal type used in output stage of battery-operated receivers. Outline 37, OUTLINES SECTION. Tube requires octal socket. Filament volts (dc), 2.0; amperes, 0.12. Typical operation as class A<sub>1</sub> amplifier: plate and grid-No.2 (screen) volts, 135 (180 *max*); grid-No.1 volts, -4.5; plate ma., 8; grid-No.2 ma., 2.4; cathode resistor, 432 ohms; output watts, 0.31. This is a DISCONTINUED type listed for reference only.

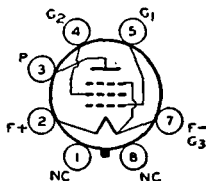

### TWIN DIODE— SHARP-CUTOFF PENTODE

## 1F6

Glass type used as combined detector, amplifier, and AVC tube in battery-operated receivers. Outline 35, OUTLINES SECTION. Tube requires six-contact socket. Filament volts (dc), 2.0; amperes, 0.06. Typical operation of pentode unit as class A<sub>1</sub> amplifier: plate volts, 180 *max*; grid-No.2 (screen) volts, 67.5 *max*; grid-No.1 volts, -1.5; plate ma., 2.2; grid-No.2 ma., 0.7. This is a DISCONTINUED type listed for reference only.

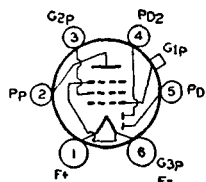

**TWIN DIODE—  
SHARP-CUTOFF PENTODE**

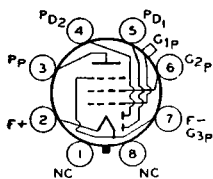

**1F7-G**

Glass octal type used as combined detector, amplifier, and avc tube in battery-operated receivers. Outline 35, OUTLINES SECTION. Tube requires octal socket. Filament volts (dc), 2.0; amperes, 0.06. Similar electrically to type 1F6 except for interelectrode capacitances. Type 1F7-G is a DISCONTINUED type listed for reference only.

**MEDIUM-MU TRIODE**

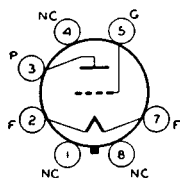

**1G4-GT**

Glass octal type used in battery-operated receivers as detector or voltage amplifier. Outline 23, OUTLINES SECTION. This type may be supplied with pin No.1 omitted. Tube requires octal socket. Filament volts (dc), 1.4; amperes, 0.05. Typical operation and characteristics as class A<sub>1</sub> amplifier: plate volts, 90 (110 max); grid volts, -6; plate ma., 2.3; plate resistance, 10700 ohms; amplification factor, 8.8; trans-

conductance, 825  $\mu$ mhos. This type has been used as a driver for type 1G6-GT. Type 1G4-GT is a DISCONTINUED type listed for reference only.

**POWER PENTODE**

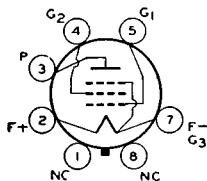

**1G5-G**

Glass octal type used in output stage of battery-operated receivers. Outline 37, OUTLINES SECTION. Tube requires octal socket. Filament volts (dc), 2.0; amperes, 0.12. Typical operation as class A<sub>1</sub> amplifier: plate and grid-No.2 (screen) volts, 135 max; grid-No.1 volts, -13.5; plate ma., 9.7; output watts, 0.55. This is a DISCONTINUED type listed for reference only.

**HIGH-MU TWIN POWER TRIODE**

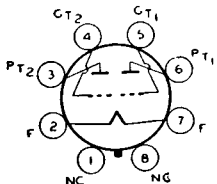

**1G6-GT**

Glass octal type used in output stage of battery-operated receivers. Outline 23, OUTLINES SECTION. Tube requires octal socket. Filament volts (dc), 1.4; amperes, 0.1. Typical operation as class B amplifier: plate volts, 90 (110 max); dc grid volts, 0; peak at grid-to-grid volts, 48; effective grid-circuit impedance per unit, 2530 ohms; plate ma. (zero signal), 2; plate ma. (maximum signal), 11; peak grid ma

per unit, 6; output watts (approx.), 0.35. This type is used principally for renewal purposes.

**MEDIUM-MU TRIODE**

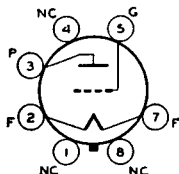

**1H4-G**

Glass octal type used as detector or voltage amplifier in battery-operated receivers. Outline 33, OUTLINES SECTION. This type may be supplied with pin No.1 omitted. Tube requires octal socket. Filament volts (dc), 2.0; amperes, 0.06. Typical operation as class A<sub>1</sub> amplifier: plate volts, 180 max; grid volts, -13.5; amplification factor, 9.3; plate resistance, 10300 ohms; transconductance, 900  $\mu$ mhos; plate ma., 3.1.

For grid-bias detection, plate volts up to 180 max may be used and grid bias adjusted so that zero-signal plate ma. is about 0.2. This is a DISCONTINUED type listed for reference only.

**DIODE—HIGH-MU TRIODE**

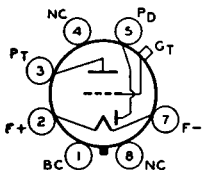

**1H5-GT**

Glass octal type used as combined detector and amplifier in battery-operated receivers. Outline 24, OUTLINES SECTION. Tube requires octal socket. Filament volts (dc), 1.4; amperes, 0.05. Characteristics of triode unit as class A<sub>1</sub> amplifier: plate volts, 90 (110 max); grid volts, 0; plate ma., 0.15; plate resistance, 240000 ohms; amplification factor, 65; transconductance, 275  $\mu$ mhos. Diode is located at negative end of filament.

1H6-G

TWIN DIODE—MEDIUM-MU TRIODE

Glass octal type used as combined detector, amplifier, and avc tube in battery-operated receivers. Outline 33, OUTLINES SECTION. Tube requires octal socket. Filament volts (dc), 2.0; amperes, 0.06. Type 1H6-G is similar electrically to type 1B5/25S. Type 1H6-G is a DISCONTINUED type listed for reference only.

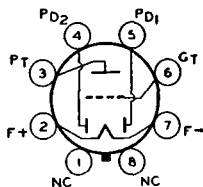

POWER PENTODE

1J5-G

Glass octal type used in output stage of battery-operated receivers. Outline 37, OUTLINES SECTION. Tube requires octal socket. Filament volts (dc), 2.0; amperes, 0.12. Typical operation as class A<sub>1</sub> amplifier: plate and grid-No.2 (screen) volts, 135 max; grid-No.1 volts, -16.5; plate ma., 7.0; grid-No.2 ma., 2.0; plate resistance, 105000 ohms; load resistance, 13500 ohms; output watts, 0.45. This is a DISCONTINUED type listed for reference only.

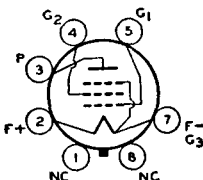

HIGH-MU TWIN POWER TRIODE

1J6-G  
1J6-GT

Glass octal types used in output stage of battery-operated receivers. Type 1J6-G, Outline 33; type 1J6-GT, Outline 27, OUTLINES SECTION. Tubes require octal socket. Filament volts (dc), 2.0; amperes, 0.24. Typical operation as class B power amplifier: plate volts, 135 max; peak plate ma. per plate, 50 max; grid volts, 0; zero-signal plate ma. per plate, 5; effective plate-to-plate load resistance, 10000

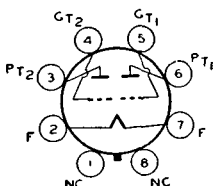

ohms; average input watts, 0.17; output watts, 2.1. These are DISCONTINUED types listed for reference only.

SHARP-CUTOFF PENTODE

1L4

Miniature type used as rf or if amplifier in portable, battery-operated receivers, particularly those not utilizing avc. Outline 13, OUTLINES SECTION. Tube requires miniature seven-

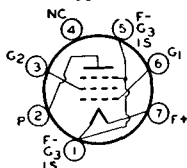

contact socket and may be mounted in any position. Internal shield eliminates need for external bulb shield, but shielding the socket is essential if minimum grid-No.1-to-plate capacitance is required. For typical operation as a resistance-coupled amplifier, refer to Chart 1, RESISTANCE-COUPLED AMPLIFIER SECTION. For filament considerations, refer to type 1U4.

|  |          |        |
|--|----------|--------|
| FILAMENT VOLTAGE (DC) .....  | 1.4      | volts  |
| FILAMENT CURRENT .....   | 0.05     | ampere |
| DIRECT INTERELECTRODE CAPACITANCES:                                    |          |        |
| Grid No.1 to Plate .....   | 0.01 max | μf     |
| Grid No.1 to Filament, Grid No.2, Grid No.3, and Internal Shield ..... | 3.6      | μf     |
| Plate to Filament, Grid No.2, Grid No.3, and Internal Shield .....     | 7.5      | μf     |

Maximum Ratings: CLASS A<sub>1</sub> AMPLIFIER

|   |         |       |
|---|---------|-------|
| PLATE VOLTAGE .....   | 110 max | volts |
| GRID-NO.2 (SCREEN) VOLTAGE .....                            | 90 max  | volts |
| GRID-NO.2 SUPPLY VOLTAGE .....                              | 110 max | volts |
| GRID-NO.1 (CONTROL-GRID) VOLTAGE, Positive Bias Value ..... | 0 max   | volts |
| TOTAL CATHODE CURRENT .....                                 | 6.5 max | ma    |

Typical Operation:

|   |      |      |        |
|---|------|------|--------|
| Plate Voltage .....                             | 90   | 90   | volts  |
| Grid-No.2 Voltage .....                         | 67.5 | 90   | volts  |
| Grid-No.1 Voltage .....                         | 0    | 0    | volts  |
| Plate Resistance .....                          | 0.6  | 0.26 | megohm |
| Transconductance .....                          | 925  | 1025 | μmhos  |
| Grid-No.1 Bias for plate current of 10 μa ..... | -6   | -10  | volts  |
| Plate Current .....                             | 2.9  | 4.5  | ma     |
| Grid-No. 2 Current .....                        | 1.2  | 2.0  | ma     |



## AVERAGE PLATE CHARACTERISTICS

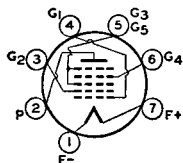
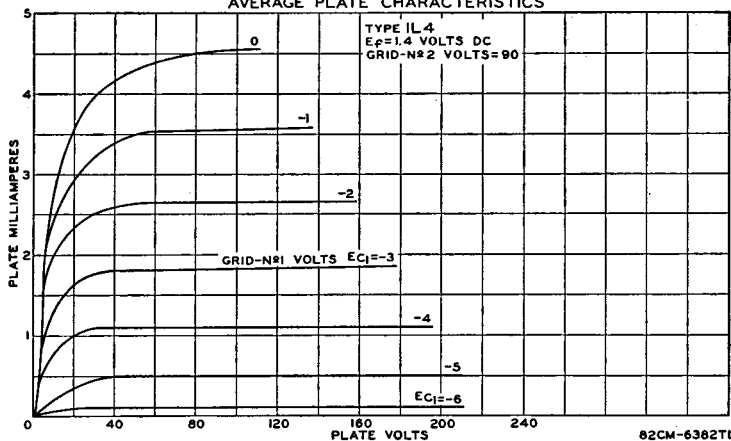

## PENTAGRID CONVERTER

Miniature type used in low-drain battery-operated receivers. Outline 13, OUTLINES SECTION. Tube requires miniature seven-contact socket and may be mounted in any position. For

# 1L6

general discussion of pentagrid types, see *Frequency Conversion* in ELECTRON TUBE APPLICATIONS SECTION.

|                             |      |        |
|-----------------------------|------|--------|
| FILAMENT VOLTAGE (DC) ..... | 1.4  | volts  |
| FILAMENT CURRENT .....      | 0.05 | ampere |

### CONVERTER SERVICE

|  |                |       |
|--|----------------|-------|
| Maximum Ratings:                           |                |       |
| PLATE VOLTAGE .....                        | 110 <i>max</i> | volts |
| GRIDS-NO.3-AND-NO.5 (SCREEN) VOLTAGE ..... | 65 <i>max</i>  | volts |
| GRIDS-NO.3-AND-NO.5 SUPPLY VOLTAGE .....   | 110 <i>max</i> | volts |
| GRID-NO.2 (OSCILLATOR-PLATE) VOLTAGE ..... | 110 <i>max</i> | volts |
| TOTAL CATHODE CURRENT .....                | 4.0 <i>max</i> | ma    |

### Characteristics (Separate Excitation):

|  |       |        |
|--|-------|--------|
| Plate Voltage .....  | 90    | volts  |
| Grids-No.3-and-No.5 (Screen) Voltage .....                           | 45    | volts  |
| Grid-No.2 (Oscillator-Plate) Voltage .....                           | 90    | volts  |
| Grid-No.4 (Mixer-Grid) Voltage .....                                 | 0     | volts  |
| Grid-No.1 (Oscillator-Grid) Resistor .....                           | 0.2   | megohm |
| Plate Resistance (Approx.) .....                                     | 0.65  | megohm |
| Plate Current .....  | 0.5   | ma     |
| Grids-No.3-and-No.5 Current .....                                    | 0.6   | ma     |
| Grid-No.2 Current .....  | 1.2   | ma     |
| Grid-No.1 Current .....  | 0.035 | ma     |
| Total Cathode Current .....  | 2.35  | ma     |
| Conversion Transconductance .....                                    | 300   | μmhos  |
| Grid-No.4 Voltage for Conversion Transconductance of 10 μmhos .....  | -3.5  | volts  |
| Grid-No.4 Voltage for Conversion Transconductance of 100 μmhos ..... | -1.3  | volts  |

NOTE: The transconductance between grid No.1 and grid No.2 connected to plate (not oscillating) is approximately 550 μmhos under the following conditions: signal applied to grid No.1 at zero bias; grid No.2 and plate at 90 volts; grids No.3 and No.5 at 45 volts; grid No.4 grounded. Under the same conditions, the plate current is 5 milliamperes, and the amplification factor is 40.

### Maximum Circuit Value (For maximum rated conditions):

|                                    |                |        |
|------------------------------------|----------------|--------|
| Grid-No.4 Circuit Resistance ..... | 1.0 <i>max</i> | megohm |
|------------------------------------|----------------|--------|

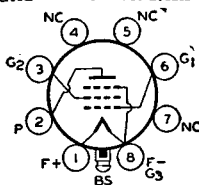

## POWER PENTODE

Glass lock-in type used in output stage of battery-operated receivers. Outline 15, OUTLINES SECTION. Tube requires lock-in socket. Filament volts (dc), 1.4; amperes, 0.05. For electrical characteristics and typical operation, refer to glass-octal type 1A5-GT. Type 1LA4 is a DISCONTINUED type listed for reference only.

# 1LA4

**PENTAGRID CONVERTER**

**1LA6**

Glass lock-in type used in battery-operated receivers. Outline 15, **OUTLINES SECTION**. Tube requires lock-in socket. Filament volts (dc), 1.4; amperes, 0.05. Typical operation as converter is the same as for type 1A7-GT except that the maximum grid-No.2 volts is 65, the maximum total cathode ma. is 4.0, the plate resistance is 0.75 megohm, and the conversion transconductance for a grid-No.4 (control-grid) bias of -3 volts is 10  $\mu$ mhos.

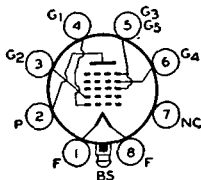

**POWER PENTODE**

**1LB4**

Glass lock-in type used in output stage of battery-operated receivers. Outline 15, **OUTLINES SECTION**. Tube requires lock-in socket. Filament volts (dc), 1.4; amperes, 0.05. For electrical characteristics, refer to pentode unit of glass-octal type 1D8-GT.

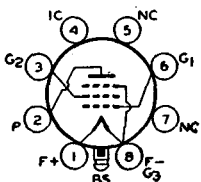

**SHARP-CUTOFF PENTODE**

**1LC5**

Glass lock-in type used as rf or if amplifier in battery-operated receivers. Outline 15, **OUTLINES SECTION**. Tube requires lock-in socket. Filament volts (dc), 1.4; amperes, 0.05. Typical operation as class A<sub>1</sub> amplifier: plate volts, 90 (110 *max*); grid-No.2 (screen) volts, 45 *max*; grid-No.1 volts, 0; plate resistance (approx.), greater than 1 megohm; transconductance, 775  $\mu$ mhos; plate ma., 1.15; grid-No.2 ma., 0.3.

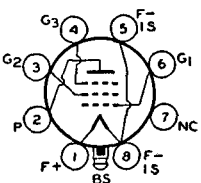

**PENTAGRID CONVERTER**

**1LC6**

Glass lock-in type used in battery-operated receivers. Outline 15, **OUTLINES SECTION**. Tube requires lock-in socket. Filament volts (dc), 1.4; amperes, 0.05. Typical operation as converter: plate volts, 90 (110 *max*); grids-No.3-and-No.5 volts, 35 (45 *max*); grid-No.2 volts, 45; grid-No.1 volts, 0; plate resistance, 0.65 megohm; plate ma., 0.75; grids-No.3-and-No.5 ma., 0.70; grid-No.2 ma., 1.4; total cathode ma., 2.9; conversion transconductance (zero bias), 275  $\mu$ mhos.

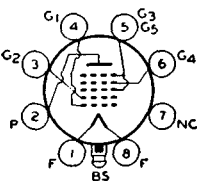

**DIODE—SHARP-CUTOFF PENTODE**

**1LD5**

Glass lock-in type used as combined detector and af voltage amplifier in battery-operated receivers. Outline 15, **OUTLINES SECTION**. Tube requires lock-in socket. Filament volts (dc), 1.4; amperes, 0.05. Characteristics of pentode unit: plate volts, 90 (110 *max*); grid-No.2 volts, 45; grid-No.1 volts, 0; plate ma., 0.6; grid-No.2 ma., 0.1; plate resistance, 0.75 megohm; transconductance, 575  $\mu$ mhos.

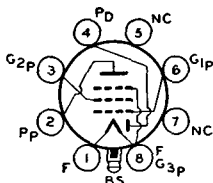

**MEDIUM-MU TRIODE**

**1LE3**

Glass lock-in type used as detector or voltage amplifier in battery-operated receivers. Outline 15, **OUTLINES SECTION**. Tube requires lock-in socket. Filament volts (dc), 1.4; amperes, 0.05. Typical operation as class A<sub>1</sub> amplifier: plate volts, 90 (110 *max*); grid volts, -3; plate ma., 1.4; plate resistance, 19000 ohms; transconductance, 760  $\mu$ mhos; amplification factor, 14.5.

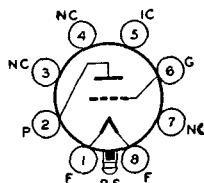

## REMOTE-CUTOFF PENTODE

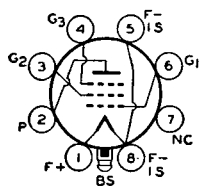

Lock-in type used as rf or if amplifier in battery-operated receivers. Outline 15, OUTLINES SECTION. Tube requires lock-in socket. Filament volts (dc), 1.4; amperes, 0.05. Typical operation and maximum ratings as class A<sub>1</sub> amplifier: plate volts, 90 (110 *max*); grid-No.2 volts, 45 (110 *max*); grid-No.1 volts, 0; plate resistance (approx.), greater than 1 megohm; transconductance, 800  $\mu$ mhos; plate ma., 1.7; grid-No.2 ma., 0.4; grid-No.1 voltage for transconductance of 10  $\mu$ mhos, -10 volts.

# 1LG5

## DIODE—HIGH-MU TRIODE

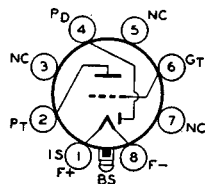

Glass lock-in type used as combined detector and amplifier in battery-operated receivers. Outline 15, OUTLINES SECTION. Tube requires lock-in socket. Filament volts (dc), 1.4; amperes, 0.05. For electrical characteristics, refer to glass-octal type 1H5-GT.

# 1LH4

## SHARP-CUTOFF PENTODE

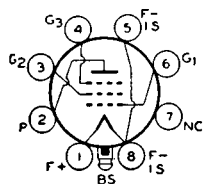

Glass lock-in type used as rf or if amplifier in battery-operated receivers. Outline 15, OUTLINES SECTION. Tube requires lock-in socket. Filament volts (dc), 1.4; amperes, 0.05. Typical operation as class A<sub>1</sub> amplifier: plate and grid-No.2 (screen) volts, 90 (110 *max*); grid-No.1 volts, 0; plate ma., 1.6; grid-No.2 ma., 0.35; plate resistance (approx.), 1.1 megohms; transconductance, 800  $\mu$ mhos.

# 1LN5

## SHARP-CUTOFF PENTODE

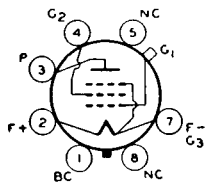

Glass octal type used as rf or if amplifier in battery-operated receivers. Outline 24, OUTLINES SECTION. Tube requires octal socket and may be mounted in any position. When used

# 1N5-GT

in avc circuits, the 1N5-GT should be only partially controlled to avoid excessive reduction in receiver sensitivity with large signal input.

|  |                  |         |
|--|------------------|---------|
| FILAMENT VOLTAGE (DC).....                           | 1.4              | volts   |
| FILAMENT CURRENT.....                                | 0.05             | ampere  |
| DIRECT INTERELECTRODE CAPACITANCES:*                 |                  |         |
| Grid No.1 to Plate.....                              | 0.007 <i>max</i> | $\mu$ f |
| Grid No.1 to Filament, Grid No.2, and Grid No.3..... | 2.8              | $\mu$ f |
| Plate to Filament, Grid No.2, and Grid No.3.....     | 9.0              | $\mu$ f |

\* With external shield connected to negative filament terminal.

### Typical Operation:

### CLASS A<sub>1</sub> AMPLIFIER

|  |     |            |
|--|-----|------------|
| Plate Voltage (110 volts <i>max</i> ).....                         | 90  | volts      |
| Grid-No.2 (Screen) Voltage (110 volts <i>max</i> ).....            | 90  | volts      |
| Grid-No.1 Voltage.....   | 0   | volts      |
| Plate Resistance (Approx.).....                                    | 1.5 | megohms    |
| Transconductance.....  | 750 | $\mu$ mhos |
| Grid-No.1 Bias (Approx.) for transconductance of 5 $\mu$ mhos..... | -4  | volts      |
| Plate Current.....   | 1.2 | ma         |
| Grid-No.2 Current.....   | 0.3 | ma         |

**DIODE—POWER PENTODE**

Glass octal type used as combined detector and power output tube in battery-operated receivers. Filament volts (dc), 1.4; amperes, 0.05. Typical operation of pentode unit as class A<sub>1</sub> amplifier: plate and grid-No.2 (screen) volts, 90 (110 max); grid-No.1 volts, -4.5; plate ma., 3.1; grid-No.2 ma. (zero-signal), 0.6; plate resistance (approx.), 0.3 megohm; transconductance, 800 μmhos; load resistance, 25000 ohms; output watts, 0.1. This is a **DISCONTINUED** type listed for reference only.

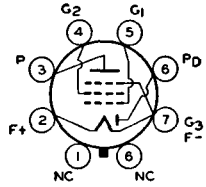

**1N6-G**

**REMOTE-CUTOFF PENTODE**

Glass octal type used as rf or if amplifier in battery-operated receivers. Outline 24, OUTLINES SECTION. Tube requires octal socket. Filament volts (dc), 1.4; amperes, 0.05. Typical operation as class A<sub>1</sub> amplifier: plate volts, 90 (110 max); grid-No.2 (screen) volts, 90 (110 max); grid-No.1 volts, 0; plate resistance (approx.), 0.8 megohm; transconductance, 750 μmhos; transconductance (approx.) with -12

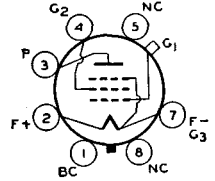

**1P5-GT**

volts on grid-No.1, 10 μmhos; plate ma., 2.3; grid-No.2 ma., 0.7. This is a **DISCONTINUED** type listed for reference only.

**BEAM POWER TUBE**

Glass octal type used in the output stage of battery-operated receivers. Outline 23, OUTLINES SECTION. This type may be supplied with pin No.1 omitted. Tube requires octal socket. Filament volts (dc), 1.4; amperes, 0.1. For electrical characteristics and ratings, refer to type 3Q5-GT with parallel filament arrangement. Type 1Q5-GT is used principally for renewal purposes.

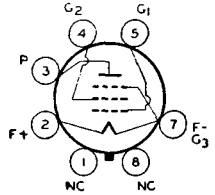

**1Q5-GT**

**PENTAGRID CONVERTER**

Miniature type used in lightweight, portable, compact, battery-operated receivers. Outline 13, OUTLINES SECTION. Tube requires miniature seven-contact socket and may be mounted in

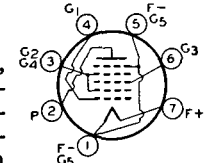

**1R5**

any position. For general discussion of pentagrid types, see *Frequency Conversion* in **ELECTRON TUBE APPLICATIONS SECTION**. For filament considerations, refer to type 1U4.

|  |         |        |
|--|---------|--------|
| FILAMENT VOLTAGE (DC) .....                          | 1.4     | volts  |
| FILAMENT CURRENT .....                               | 0.05    | ampere |
| <b>DIRECT INTERELECTRODE CAPACITANCES:</b>           |         |        |
| Grid No.3 to All Other Electrodes (RF Input) .....   | 7.0     | μμf    |
| Plate to All Other Electrodes (Mixer Output) .....   | 7.5     | μμf    |
| Grid No.1 to All Other Electrodes (Osc. Input) ..... | 3.8     | μμf    |
| Grid No.3 to Plate .....                             | 0.4 max | μμf    |
| Grid No.3 to Grid No.1 .....                         | 0.2 max | μμf    |
| Grid No.1 to Plate .....                             | 0.1 max | μμf    |

**Maximum Ratings:**

**CONVERTER SERVICE**

|   |          |       |
|---|----------|-------|
| PLATE VOLTAGE .....   | 90 max   | volts |
| GRIDS-NO.2-AND-NO.4 (SCREEN) VOLTAGE .....                  | 67.5 max | volts |
| GRIDS-NO.2-AND-NO.4 SUPPLY VOLTAGE .....                    | 90 max   | volts |
| GRID-NO.3 (CONTROL-GRID) VOLTAGE, Positive Bias Value ..... | 0 max    | volts |
| TOTAL ZERO-SIGNAL CATHODE CURRENT .....                     | 5.5 max  | ma    |

**Typical Operation:**

|                                   |     |      |     |      |        |
|-----------------------------------|-----|------|-----|------|--------|
| Plate Voltage .....               | 45  | 67.5 | 90  | 90   | volts  |
| Grids-No.2-and-No.4 Voltage ..... | 45  | 67.5 | 45  | 67.5 | volts  |
| Grid-No.3 Voltage .....           | 0   | 0    | 0   | 0    | volts  |
| Grid-No.1 Resistor .....          | 0.1 | 0.1  | 0.1 | 0.1  | megohm |

|   |      |      |      |      |            |
|---|------|------|------|------|------------|
| Plate Resistance (Approx.)  | 0.6  | 0.5  | 0.8  | 0.6  | megohm     |
| Conversion Transconductance   | 235  | 280  | 250  | 300  | $\mu$ mhos |
| Grid-No.3 Bias for conversion trans-conductance of approx. 5 $\mu$ mhos | -9   | -14  | -9   | -14  | volts      |
| Plate Current   | 0.7  | 1.4  | 0.8  | 1.6  | ma         |
| Grids-No.2-and-No.4 Current   | 1.9  | 3.2  | 1.9  | 3.2  | ma         |
| Grid-No.1 Current   | 0.15 | 0.25 | 0.15 | 0.25 | ma         |
| Total Cathode Current   | 2.75 | 5    | 2.75 | 5    | ma         |

NOTE: The transconductance between grid No.1 and grids No.2 and No.4 tied to plate (not oscillating) is approximately 1400  $\mu$ mhos under the following conditions: grids No.1 and No.3 at 0 volts; grids No.2 and No.4 and plate at 67.5 volts.

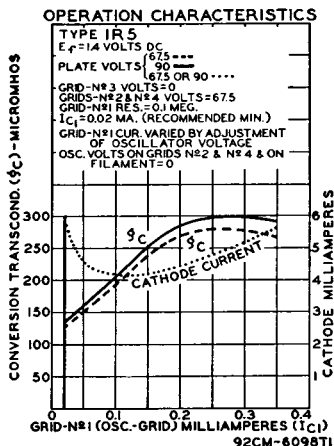

**OPERATION CHARACTERISTICS**

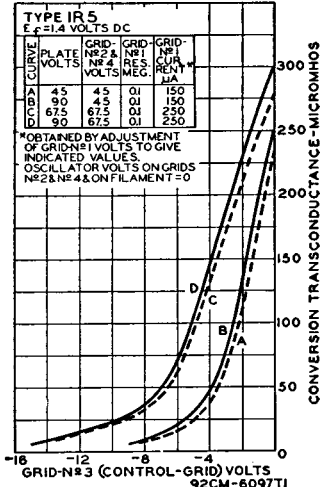

### POWER PENTODE

Miniature type used in output stage of lightweight, compact, portable, battery-operated equipment. Types 1S4 and 3S4 are identical except for filament arrangement. Outline 13, OUTLINES SECTION. Type 1S4 requires miniature seven-contact socket and may be mounted in any position. For ratings, typical operation, and curves, refer to type 3S4 with parallel filament arrangement. For filament considerations, refer to type 1U4 and ELECTRON TUBE INSTALLATION SECTION. Filament volts (dc), 1.4; amperes, 0.1. This type is used principally for renewal purposes.

## 1S4

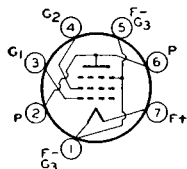

### DIODE—

### SHARP-CUTOFF PENTODE

Miniature type used in lightweight, compact, portable, battery-operated receivers as combined detector and af voltage amplifier. Outline 13, OUTLINES SECTION. Filament volts (dc), 1.4; amperes, 0.05. Tube requires miniature seven-contact socket and may be mounted in any position. For electrical characteristics, curves, and application, refer to type 1U5.

## 1S5

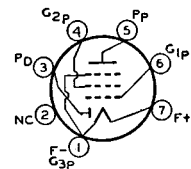

OUTLINES SECTION. Filament volts (dc), 1.4; amperes, 0.05. Tube requires miniature seven-contact socket and may be mounted in any position. For electrical characteristics, curves, and application, refer to type 1U5.

### REMOTE-CUTOFF PENTODE

Miniature type used in lightweight, compact, portable, battery-operated receivers as rf or af amplifier. Because of internal shielding feature, an external bulb shield is not needed,

## 1T4

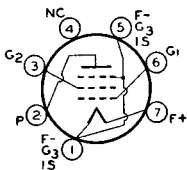

but socket shielding is essential if minimum grid-No.1-to-plate capacitance is to be obtained. Outline 13, **OUTLINES SECTION**. Tube requires miniature seven-contact socket and may be mounted in any position. For filament considerations, refer to type 1U4.

|  |                 |                  |
|--|-----------------|------------------|
| FILAMENT VOLTAGE (DC) .....  | 1.4             | volts            |
| FILAMENT CURRENT .....   | 0.05            | ampere           |
| <b>DIRECT INTERELECTRODE CAPACITANCES:*</b>                        |                 |                  |
| Grid No.1 to Plate .....   | 0.01 <i>max</i> | $\mu\mu\text{f}$ |
| Grid No.1 to Filament, Grid No.2, Grid No.3, and Internal Shield   | 3.6             | $\mu\mu\text{f}$ |
| Plate to Filament, Grid No.2, Grid No.3, and Internal Shield ..... | 7.5             | $\mu\mu\text{f}$ |

\* With close-fitting shield connected to negative filament terminal.

### Maximum Ratings:

### CLASS A<sub>1</sub> AMPLIFIER

|   |                 |       |
|---|-----------------|-------|
| PLATE VOLTAGE .....   | 90 <i>max</i>   | volts |
| GRID-NO.2 (SCREEN) VOLTAGE .....                            | 67.5 <i>max</i> | volts |
| GRID-NO.2 SUPPLY VOLTAGE .....                              | 90 <i>max</i>   | volts |
| GRID-NO.1 (CONTROL-GRID) VOLTAGE, Positive Bias Value ..... | 0 <i>max</i>    | volts |
| TOTAL CATHODE CURRENT .....                                 | 5.5 <i>max</i>  | ma    |

### Typical Operation:

|  |      |      |      |      |                  |
|--|------|------|------|------|------------------|
| Plate Voltage .....  | 45   | 67.5 | 90   | 90   | volts            |
| Grid-No.2 Voltage .....  | 45   | 67.5 | 45   | 67.5 | volts            |
| Grid-No.1 Voltage .....  | 0    | 0    | 0    | 0    | volts            |
| Plate Resistance (Approx.) .....                                 | 0.35 | 0.25 | 0.8  | 0.5  | megohm           |
| Transconductance .....   | 700  | 875  | 750  | 900  | $\mu\text{mhos}$ |
| Grid-No.1 Bias for transconductance of 10 $\mu\text{mhos}$ ..... | -10  | -16  | -10  | -16  | volts            |
| Plate Current .....  | 1.7  | 3.4  | 1.8  | 3.5  | ma               |
| Grid-No.2 Current .....  | 0.7  | 1.5  | 0.65 | 1.4  | ma               |

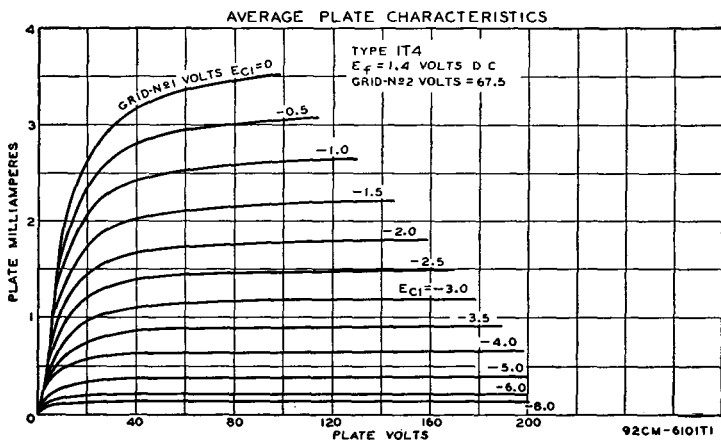

### BEAM POWER TUBE

Glass octal type used in output stage of battery-operated receivers. Outline 23, **OUTLINES SECTION**. This type may be supplied with pin No.1 omitted. Tube requires octal socket. Filament volts (dc), 1.4; amperes, 0.05. For filament considerations, refer to type 1U4. Typical operation as class A<sub>1</sub> amplifier with fixed bias: plate and grid-No.2 (screen) volts, 90 (110 *max*); grid-No.1 volts, -6; peak af grid-

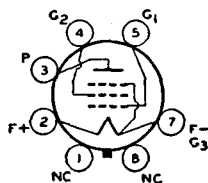

## 1T5-GT

No.1 volts, 6; plate ma. (maximum or zero-signal), 6.5; grid-No.2 ma. (zero-signal), 0.8; grid-No.2 ma. (maximum signal), 1.5; plate resistance, 0.25 megohm; transconductance, 1150  $\mu\text{mhos}$ ; load resistance, 14000 ohms; total harmonic distortion, 7.5 per cent; output watts, 0.17. This is a **DISCONTINUED** type listed for reference only.

**DIODE—SHARP-CUTOFF  
PENTODE**

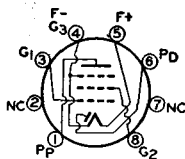

**1T6**

Subminiature type used as combined detector and audio amplifier in small, compact, battery-operated receivers for the standard AM broadcast band. The 1T6 and the other RCA

subminiature types 1AC5, 1AD5, and 1E8 comprise a complete tube complement for lightweight portable radio receivers having extremely low battery drain. Outline 8, **OUTLINES SECTION**. Tube requires subminiature eight-contact socket and may be mounted in any position. For installation and application considerations, refer to type 1AC5.

|                            |      |        |
|----------------------------|------|--------|
| FILAMENT VOLTAGE (DC)..... | 1.25 | volts  |
| FILAMENT CURRENT.....      | 0.04 | ampere |

**Maximum Ratings: PENTODE UNIT AS CLASS A<sub>1</sub> AMPLIFIER**

|                                 |          |       |
|---------------------------------|----------|-------|
| PLATE VOLTAGE.....              | 67.5 max | volts |
| GRID-NO.2 (SCREEN) VOLTAGE..... | 67.5 max | volts |
| TOTAL CATHODE CURRENT.....      | 2.0 max  | ma    |

**Typical Operation:**

|                                       |      |      |      |        |
|---------------------------------------|------|------|------|--------|
| Plate Voltage.....                    | 30   | 45   | 67.5 | volts  |
| Grid-No.2 (Screen) Voltage.....       | 30   | 45   | 67.5 | volts  |
| Grid-No.1 (Control-Grid) Voltage..... | 0    | 0    | 0    | volts  |
| Plate Resistance (Approx.).....       | 0.5  | 0.5  | 0.4  | megohm |
| Transconductance.....                 | 330  | 475  | 600  | μmhos  |
| Plate Current.....                    | 0.33 | 0.75 | 1.6  | ma     |
| Grid-No.2 Current.....                | 0.10 | 0.21 | 0.4  | ma     |

**DIODE UNIT**

**Maximum Rating:**

|                    |          |    |
|--------------------|----------|----|
| PLATE CURRENT..... | 0.25 max | ma |
|--------------------|----------|----|

Diode unit is located at negative end of filament and is independent of the pentode unit except for the common filament.

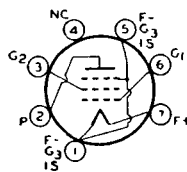

**SHARP-CUTOFF PENTODE**

Miniature type used as rf or if amplifier in stages not controlled by avc in lightweight, compact, portable, battery-operated equipment. Because the screen can be operated at the same

**1U4**

voltage as the plate, a voltage-dropping resistor is not needed. For typical operation as a resistance-coupled amplifier, refer to Chart 3, **RESISTANCE-COUPLED AMPLIFIER SECTION**.

|   |          |        |
|---|----------|--------|
| FILAMENT VOLTAGE (DC).....  | 1.4      | volts  |
| FILAMENT CURRENT.....   | 0.05     | ampere |
| <b>DIRECT INTERELECTRODE CAPACITANCES*:</b>                           |          |        |
| Grid No.1 to Plate.....   | 0.01 max | μf     |
| Grid No.1 to Filament, Grid No.2, Grid No.3, and Internal Shield..... | 3.6      | μf     |
| Plate to Filament, Grid No.2, Grid No.3, and Internal Shield.....     | 7.5      | μf     |

\* External shield connected to negative filament terminal.

**Maximum Ratings: CLASS A<sub>1</sub> AMPLIFIER**

|  |         |       |
|--|---------|-------|
| PLATE VOLTAGE.....                       | 110 max | volts |
| GRID-NO.2 (SCREEN) VOLTAGE.....          | 110 max | volts |
| <b>GRID-NO.1 (CONTROL-GRID) VOLTAGE:</b> |         |       |
| Negative bias value.....                 | 30 max  | volts |
| Positive bias value.....                 | 0 max   | volts |
| TOTAL CATHODE CURRENT.....               | 6 max   | ma    |

## Typical Operation:

|   |     |            |
|---|-----|------------|
| Plate Voltage.....  | 90  | volts      |
| Grid-No.2 Voltage.....                                    | 90  | volts      |
| Grid-No.1 Voltage.....                                    | 0   | volts      |
| Plate Resistance (Approx.).....                           | 1.0 | megohm     |
| Transconductance.....                                     | 900 | $\mu$ mhos |
| Grid-No.1 Bias for transconductance of 10 $\mu$ mhos..... | -4  | volts      |
| Plate Current.....  | 1.6 | ma         |
| Grid-No.2 Current.....                                    | 0.6 | ma         |

## INSTALLATION AND APPLICATION

Type 1U4 requires a miniature seven-contact socket and may be mounted in any position. Outline 13, OUTLINES SECTION.

The filament power supply may be obtained from dry-cell batteries, from storage batteries, or from a power line. With dry-cell battery supply, the filament may be connected either directly across a battery rated at a terminal potential of 1.5 volts, or in series with the filaments of similar tubes across a power supply consisting of dry cells in series. In either case, the voltage across the filament should not exceed 1.6 volts.

With power-line or storage-battery supply, the filament may be operated in series with the filaments of other tubes of the same filament-current rating. For such operation, design adjustments should be made so that, with tubes of rated characteristics operating with all electrode voltages applied and on a normal line voltage of 117 volts or on a normal storage-battery voltage of 2.0 volts per cell (without a charger) or 2.2 volts per cell (with a charger), the voltage drop across the filament will be maintained within a range of 1.25 to 1.4 volts with a center of 1.3 volts.

In order to meet the recommended conditions for operating filaments in series from dry-battery, storage-battery, or power-line sources, it may be necessary to use shunting resistors across the individual 1.4-volt sections of filament. Refer to ELECTRON TUBE INSTALLATION SECTION for additional filament considerations.

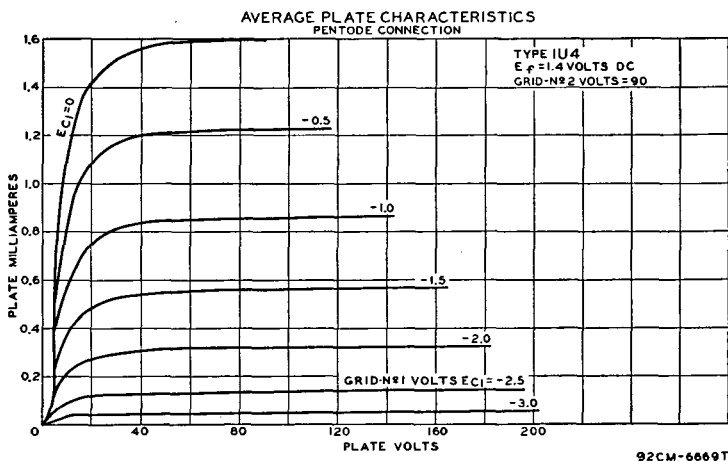

## DIODE—SHARP-CUTOFF PENTODE

# 1U5

Miniature type used in light-weight, compact, portable, battery-operated receivers as combined detector and af voltage amplifier. The 1U5 is similar to the 1S5 but utilizes an im-

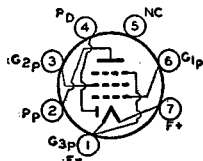



proved structure which greatly reduces any tendency toward microphonic effects. In addition, the diode unit is effectively shielded from the pentode unit to prevent "play-through." Outline 13, OUTLINES SECTION. Tube requires miniature seven-contact socket and may be mounted in any position. For typical operation as a resistance-coupled amplifier, refer to Chart 2, RESISTANCE-COUPLED AMPLIFIER SECTION. For filament considerations, refer to type 1U4.

|                            |      |        |
|----------------------------|------|--------|
| FILAMENT VOLTAGE (DC)..... | 1.4  | volts  |
| FILAMENT CURRENT.....      | 0.05 | ampere |

### Maximum Ratings: PENTODE UNIT AS CLASS A<sub>1</sub> AMPLIFIER

|                                   |        |       |
|-----------------------------------|--------|-------|
| PLATE VOLTAGE.....                | 90 max | volts |
| GRID-NO.2 (SCREEN) VOLTAGE.....   | 90 max | volts |
| GRID-NO.1 (CONTROL-GRID) VOLTAGE: |        |       |
| Negative bias value.....          | 50 max | volts |
| Positive bias value.....          | 0 max  | volts |
| TOTAL CATHODE CURRENT.....        | 3 max  | ma    |

### Characteristics:

|  |      |        |
|--|------|--------|
| Plate Voltage.....                             | 67.5 | volts  |
| Grid-No.2 Voltage.....                         | 67.5 | volts  |
| Grid-No.1 Voltage.....                         | 0    | volts  |
| Plate Resistance.....                          | 0.6  | megohm |
| Transconductance.....                          | 625  | μmhos  |
| Grid-No.1 Bias for plate current of 10 μa..... | -5   | volts  |
| Plate Current.....                             | 1.6  | ma     |
| Grid-No.2 Current.....                         | 0.4  | ma     |

### Maximum Rating: DIODE UNIT

|                    |          |    |
|--------------------|----------|----|
| PLATE CURRENT..... | 0.25 max | ma |
|--------------------|----------|----|

Diode unit is located at negative end of filament and is independent of the pentode except for the common filament.

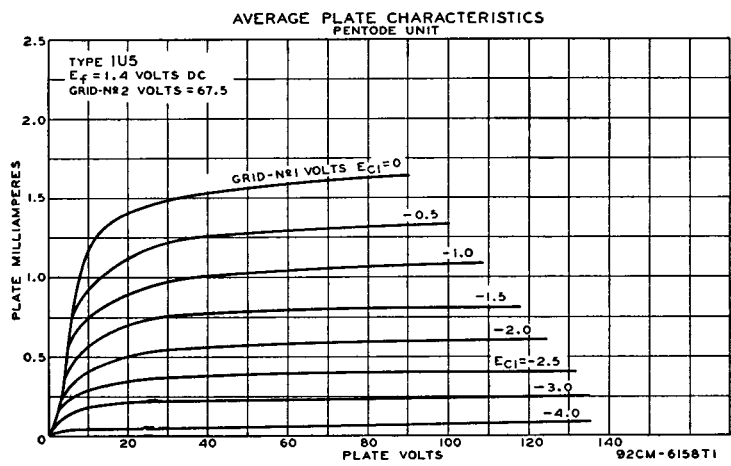

### HALF-WAVE VACUUM RECTIFIER

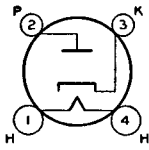

Glass type used in ac/dc or automobile receivers. Outline 31 or 34, OUTLINES SECTION. Tube requires four-contact socket. For heater considerations, refer to type 6AT6. Heater volts (ac/dc), 6.3; amperes, 0.3. Maximum ratings as half-wave rectifier: peak inverse plate volts, 1000; peak plate ma., 270; peak heater-cathode volts, 500; dc output ma., 45. This type is used principally for renewal purposes.

**1-v**

### HALF-WAVE VACUUM RECTIFIER

## 1V2

Miniature type used in high-voltage, low-current applications such as the rectifier in high-voltage, pulse-operated voltage-doubling power supplies for kinescopes. The very low power

required by the filament permits the use of a rectifier transformer having small size and light weight. For curve of average plate characteristics, see page 61.

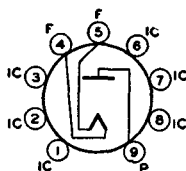

|                                    |       |        |
|------------------------------------|-------|--------|
| FILAMENT VOLTAGE (AC) .....        | 0.625 | volt   |
| FILAMENT CURRENT .....             | 0.3   | ampere |
| DIRECT INTERELECTRODE CAPACITANCE: |       |        |
| Plate to Filament (Approx.) .....  | 0.8   | μf     |

#### PULSED-RECTIFIER SERVICE

*For operation in a 525-line, 30-frame system*

#### Maximum Ratings

|                                  |          |       |
|----------------------------------|----------|-------|
| PEAK INVERSE PLATE VOLTAGE ..... | 7500 max | volts |
| PEAK PLATE CURRENT .....         | 10 max   | ma    |
| AVERAGE PLATE CURRENT .....      | 0.5 max  | ma    |

### INSTALLATION AND APPLICATION

Type 1V2 requires a noval nine-contact socket and may be mounted in any position. The socket should be made of material having low leakage and should have adequate insulation between its filament and plate terminals to withstand the maximum peak inverse plate voltage. To provide the required insulation in noval nine-contact sockets designed with a cylindrical center shield, it is necessary to remove the center shield. In addition, it is recommended that the socket clips for pins 1, 6, and 7 be removed to reduce the possibility of arc-over and minimize leakage. Outline 14, OUTLINES SECTION.

The filament is of the coated type and is designed for operation at 0.625 volt. The filament windings on the pulse transformer should be adjusted to provide the rated voltage under average line-voltage conditions. When the filament voltage is measured, it is recommended that an rms voltmeter of the thermal type be used. The meter and its leads must be insulated to withstand 15000 volts and the stray capacitances to ground should be minimized.

The high voltages at which the 1V2 is operated are very dangerous. Great care should be taken to prevent coming in contact with these high voltages. Particular care against fatal shock should be taken in measuring the filament voltage in those circuits where the filament is not grounded. Precautions must include safeguards which definitely eliminate all hazards to personnel.

## 1X2-A 1X2-B

### HALF-WAVE VACUUM RECTIFIER

Miniature types used in high-voltage, low-current applications such as the rectifier in a high-voltage, rf-operated power supply, or as the rectifier of high-voltage pulses produced in television scanning systems. Outline 19, OUTLINES SECTION. Tubes require noval nine-contact socket and may be mounted in any position. Plate connection is cap at top of bulb. Pins 3 and 7 may be used as tie points for filament dropping resistor and high-voltage filter resistor, or may be connected to the filament. These pins should *not* be connected to low-potential circuits. For other filament and high-voltage considerations, refer to type 1B3-GT. For curve of average plate characteristics, see page 61.

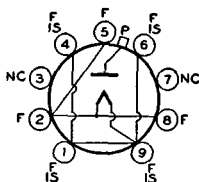

Pin 5 is at the top, pin 9 at the bottom, pin 1 on the left, and pin 7 on the right. Pins 2, 3, 4, 6, 8 are arranged in a ring between the others. Labels 'F' are above pins 4 and 6, and 'IS' are to the left of pins 3, 2, 1 and to the right of pins 7, 8, 9. A schematic symbol for a half-wave vacuum rectifier is shown inside the circle, with the filament connected to pins 4 and 6, and the plate connected to pin 5.

# RCA Receiving Tube Manual

|                                    |      |               |
|------------------------------------|------|---------------|
| FILAMENT VOLTAGE (AC).....         | 1.25 | volts         |
| FILAMENT CURRENT.....              | 0.2  | ampere        |
| DIRECT INTERELECTRODE CAPACITANCE: |      |               |
| Plate to Filament (Approx.).....   | 1.0  | $\mu\text{f}$ |

## PULSED-RECTIFIER SERVICE

*For operation in a 525-line, 30-frame system*

|  |              |              |       |
|--|--------------|--------------|-------|
| <b>Maximum Ratings:</b>  | <i>1X2-A</i> | <i>1X2-B</i> |       |
| PEAK INVERSE PLATE VOLTAGE (Absolute Maximum) <sup>o</sup> ..... | 18000 max    | 22000 max    | volts |
| PEAK PLATE CURRENT.....  | 10 max       | 45 max       | ma    |
| AVERAGE PLATE CURRENT.....                                       | 1 max        | 0.5 max      | ma    |

### Typical Operation:

|                                   |       |       |               |
|-----------------------------------|-------|-------|---------------|
| <b>Peak Plate Supply Voltage:</b> |       |       |               |
| Positive Pulse Value.....         | 14000 | 18000 | volts         |
| Negative Pulse Value.....         | 3500  | 2000  | volts         |
| DC Output Voltage (Approx.).....  | 14000 | 18000 | volts         |
| DC Output Current (Approx.).....  | 175   | 100   | $\mu\text{a}$ |

<sup>o</sup>The dc component must not exceed 18000 volts.

■Under no circumstances should this absolute value be exceeded.

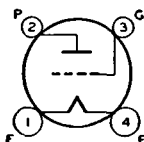

## POWER TRIODE

Glass type used in output stage of radio receivers and amplifiers. As a class A<sub>1</sub> power amplifier, the 2A3 is usable either singly or in push-pull combination.

# 2A3

|   |      |               |
|---|------|---------------|
| FILAMENT VOLTAGE (AC/DC).....                 | 2.5  | volts         |
| FILAMENT CURRENT.....                         | 2.5  | amperes       |
| DIRECT INTERELECTRODE CAPACITANCES (Approx.): |      |               |
| Grid to Plate.....                            | 16.5 | $\mu\text{f}$ |
| Grid to Filament.....                         | 7.5  | $\mu\text{f}$ |
| Plate to Filament.....                        | 5.5  | $\mu\text{f}$ |

### Maximum Ratings: CLASS A<sub>1</sub> AMPLIFIER

|                        |         |       |
|------------------------|---------|-------|
| PLATE VOLTAGE.....     | 300 max | volts |
| PLATE DISSIPATION..... | 15 max  | watts |

### Typical Operation:

|                                 |      |                  |
|---------------------------------|------|------------------|
| Plate Voltage.....              | 250  | volts            |
| Grid Voltage* #.....            | -45  | volts            |
| Plate Current.....              | 60   | ma               |
| Amplification Factor.....       | 4.2  |                  |
| Plate Resistance.....           | 800  | ohms             |
| Transconductance.....           | 5250 | $\mu\text{mhms}$ |
| Load Resistance.....            | 2500 | ohms             |
| Second Harmonic Distortion..... | 5    | per cent         |
| Power Output.....               | 3.6  | watts            |

### Maximum Ratings: PUSH-PULL CLASS AB<sub>1</sub> AMPLIFIER

|                        |         |       |
|------------------------|---------|-------|
| PLATE VOLTAGE.....     | 300 max | volts |
| PLATE DISSIPATION..... | 15 max  | watts |

### Typical Operation (Values Are For Two Tubes):

|   | <i>Fixed Bias</i> | <i>Cathode Bias</i> |          |
|---|-------------------|---------------------|----------|
| Plate Voltage.....                              | 300               | 300                 | volts    |
| Grid Voltage* #.....                            | -62               | -                   | volts    |
| Cathode-Bias Resistor.....                      | -                 | 780                 | ohms     |
| Peak AF Grid-to-Grid Voltage.....               | 124               | 156                 | volts    |
| Zero-Signal Plate Current.....                  | 80                | 80                  | ma       |
| Maximum-Signal Plate Current.....               | 147               | 100                 | ma       |
| Effective Load Resistance (Plate-to-plate)..... | 3000              | 5000                | ohms     |
| Total Harmonic Distortion.....                  | 2.5               | 5.0                 | per cent |
| Power Output.....                               | 15                | 10                  | watts    |

## Maximum Circuit Values:

### Grid-Circuit Resistance:

|                                 |                 |
|---------------------------------|-----------------|
| For fixed-bias operation.....   | 0.05 max megohm |
| For cathode-bias operation..... | 0.5 max megohm  |

\* Grid voltage referred to mid-point of ac-operated filament.

# When a single 2A3 is operated cathode-biased, the cathode-biasing resistor value should be 750 ohms.

## INSTALLATION AND APPLICATION

Type 2A3 requires a four-contact socket and may be mounted in any position. Outline 43, OUTLINES SECTION. It is especially important that this tube, like other power-handling tubes, be adequately ventilated.

The values recommended for push-pull operation are different from the conventional ones usually given on the basis of characteristics for a single tube. The values shown for Push-Pull Class AB<sub>1</sub> operation cover operation with fixed bias and with cathode bias, and have been determined on the basis of no grid current flow during the most positive swing of the input signal and of cancellation of second-harmonic distortion by virtue of the push-pull circuit. The cathode resistor should preferably be shunted by a suitable filter network to minimize grid-bias variations produced by current surges in the cathode resistor.

When 2A3's are operated in push-pull, it is desirable to provide means for adjusting the bias on each tube independently. This requirement is a result of the very high transconductance of these tubes—5250 micromhos. This very high value makes the 2A3 somewhat critical as to grid-bias voltage, since a very small bias-voltage change produces a very large change in plate current. It is obvious, therefore, that the difference in plate current between two tubes may be sufficient to unbalance the system seriously. To avoid this possibility, simple methods of independent cathode-bias adjustment may be used, such as (1) input transformer with two independent secondary windings, or (2) filament transformer with two independent filament windings. With either of these methods, each tube can be biased separately so as to obtain circuit balance.

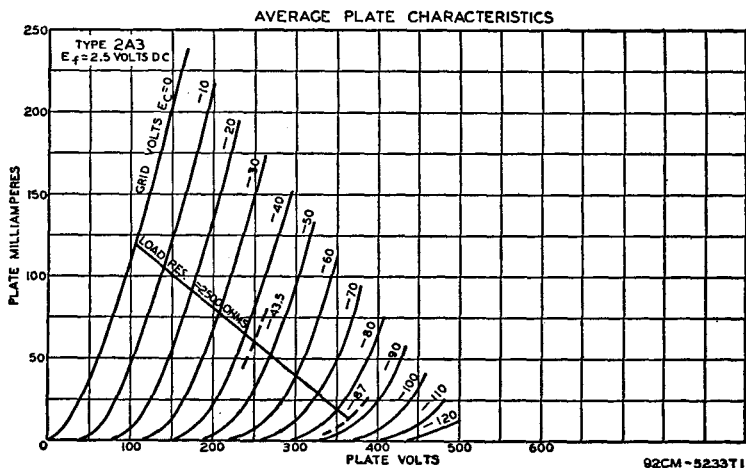

**POWER PENTODE**

Glass type used in output stage of ac-operated receivers. Outline 38, OUTLINES SECTION. Tube requires six-contact socket. Except for its heater rating (2.5 volts ac/dc; 1.75 amperes), the 2A5 has electrical characteristics identical with type 6F6. Type 2A5 is a DISCONTINUED type listed for reference only.

**2A5**

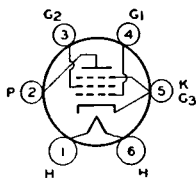

**TWIN DIODE—HIGH-MU TRIODE**

Glass type used in ac-operated receivers chiefly as a combined detector, amplifier, and avc tube. Outline 86, OUTLINES SECTION. Tube requires six-contact socket. Except for its heater rating (2.5 volts ac/dc; 0.8 ampere), and within its 250-volt maximum plate rating, the 2A6 has electrical characteristics identical with type 6SQ7. Type 2A6 is a DISCONTINUED type listed for reference only.

**2A6**

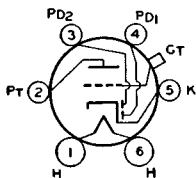

**PENTAGRID CONVERTER**

Glass type used in ac-operated receivers. Outline 36, OUTLINES SECTION. Tube requires small seven-contact (0.75-inch, pin-circle diameter) socket. Except for its heater rating (2.5 volts ac/dc; 0.8 ampere) and its interelectrode capacitances, the 2A7 has electrical characteristics identical with type 6A8. Complete shielding of this tube is generally necessary. Type 2A7 is a DISCONTINUED type listed for reference only.

**2A7**

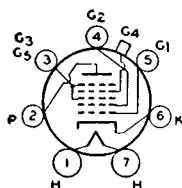

**TWIN DIODE—**

**REMOTE-CUTOFF PENTODE**

Glass type used as combined detector, avc tube, and amplifier. Outline 36, OUTLINES SECTION. Tube requires small seven-contact (0.75-inch, pin-circle diameter) socket. Except for its heater rating (2.5 volts ac/dc; 0.8 ampere) and its interelectrode capacitances, the 2B7 has electrical characteristics identical with type 6B8-G. Type 2B7 is a DISCONTINUED type listed for reference only.

**2B7**

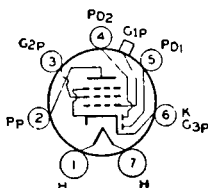

**ELECTRON-RAY TUBE**

Glass type used to indicate visually by means of a fluorescent target the effects of a change in a controlling voltage. It is used as a convenient means of indicating accurate radio receiver tuning. Outline 31 or 34, OUTLINES SECTION. Tube requires six-contact socket. Except for its heater rating (2.5 volts ac/dc; 0.8 ampere), the 2E5 has electrical characteristics identical with type 6E5. Type 2E5 is a DISCONTINUED type listed for reference only.

**2E5**

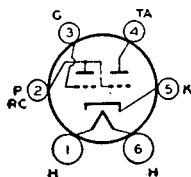

**HALF-WAVE VACUUM RECTIFIER**

Miniature type used as rectifier of high-voltage pulses produced in the scanning systems of color television receivers. Outline 19, OUTLINES SECTION. Tube requires noval nine-

**3A2**

contact socket and may be mounted in any position. For curve of average plate characteristics, see page 61.

|  |      |         |
|--|------|---------|
| HEATER VOLTAGE (AC).....                           | 3.15 | volts   |
| HEATER CURRENT.....                                | 0.22 | ampere  |
| DIRECT INTERELECTRODE CAPACITANCE (Approx.):       |      |         |
| Plate to Heater, Cathode, and Internal Shield..... | 1.0  | $\mu$ f |

### PULSED-RECTIFIER SERVICE

|   |                  |       |
|---|------------------|-------|
| <b>Maximum Ratings:</b> <i>For operation in a 525-line, 30-frame system</i> |                  |       |
| PEAK INVERSE PLATE VOLTAGE.....   | 18000 <i>max</i> | volts |
| PEAK PLATE CURRENT.....   | 80 <i>max</i>    | ma    |
| AVERAGE PLATE CURRENT.....  | 1.5 <i>max</i>   | ma    |

### HALF-WAVE VACUUM RECTIFIER

## 3A3

Glass octal type used as rectifier of high-voltage pulses produced in the scanning systems of color television receivers. Outline 30, **OUTLINES SECTION**. Tube requires octal socket

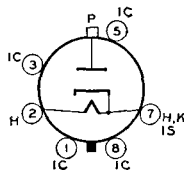

and may be mounted in any position. For curve of average plate characteristics, see page 61.

|  |      |         |
|--|------|---------|
| HEATER VOLTAGE (AC).....                           | 3.15 | volts   |
| HEATER CURRENT.....                                | 0.22 | ampere  |
| DIRECT INTERELECTRODE CAPACITANCE (Approx.):       |      |         |
| Plate to Heater, Cathode, and Internal Shield..... | 1.5  | $\mu$ f |

### PULSED-RECTIFIER SERVICE

|   |                  |       |
|---|------------------|-------|
| <b>Maximum Ratings:</b> <i>For operation in a 525-line, 30-frame system</i> |                  |       |
| PEAK INVERSE PLATE VOLTAGE.....   | 30000 <i>max</i> | volts |
| PEAK PLATE CURRENT.....   | 80 <i>max</i>    | ma    |
| AVERAGE PLATE CURRENT.....  | 1.5 <i>max</i>   | ma    |

### DIODE—TRIODE—PENTODE

Glass octal type used as combined detector, af amplifier, and rf amplifier in battery-operated receivers. Filament has mid-tap so that tube may be used with either 1.4- or 2.8-volt dc filament supplies. Filament volts 1.4 (parallel), 2.8 (series); amperes 0.1 (parallel), 0.05 (series). Typical operation of triode unit as class A<sub>1</sub> amplifier: plate volts, 90 (110 *max*); grid volts, 0;

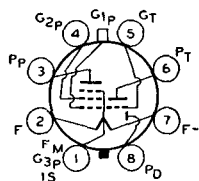

amplification factor, 65; plate resistance, 0.2 megohm; transconductance, 325  $\mu$ mhos; plate ma., 0.2. (Typical operation of pentode unit as class A<sub>1</sub> amplifier: plate volt, 90 (110 *max*); grid-No.2 volts, 90 (110 *max*); grid-No.1 volts, 0; plates resistance, 0.8 megohm; transconductance, 750  $\mu$ mhos; plate ma. 1.5; grid-No. 2 ma., 0.5. This is a **DISCONTINUED** type listed for reference only.

### BEAM POWER TUBE

Glass lock-in type used in output stage of ac/dc/battery portable receivers. Outline 15, **OUTLINES SECTION**. Tube requires lock-in socket. Filament volts (dc) 1.4 (parallel), 2.8 (series); amperes 0.1 (parallel), 0.05 (series). For electrical characteristics, refer to glass-octal type 3Q5-GT.

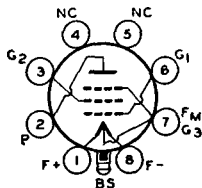

## 3LF4

### POWER PENTODE

Miniature type used in output stage of lightweight, compact, portable, battery-operated equipment. Outline 13, **OUTLINES SECTION**. Except for terminal connections, types 3Q4 and

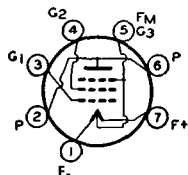

## 3Q4

3V4 are identical. Refer to type 3V4 for ratings, typical operation, curves, and installation considerations.

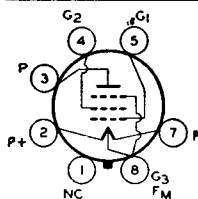

**BEAM POWER TUBE**

**3Q5-GT**

Glass octal type used in output stage of ac/dc/battery portable receivers. Outline 22 or 23, OUTLINE SECTION. This type may be supplied with pin No.1 omitted. Tube requires

octal socket and may be mounted in any position. For series filament arrangement, filament voltage is applied between pins 2 and 7. For parallel filament arrangement, filament voltage is applied between pin 8 and pins 2 and 7 connected together. For additional filament considerations, refer to type 3V4 and ELECTRON TUBE INSTALLATION SECTION.

| Filament Arrangement  | Series | Parallel |        |
|-----------------------|--------|----------|--------|
| FILAMENT VOLTAGE (DC) | 2.8    | 1.4      | volts  |
| FILAMENT CURRENT      | 0.05   | 0.1      | ampere |

**CLASS A<sub>1</sub> AMPLIFIER**

| Maximum Ratings:                  | Series  | Parallel |       |
|-----------------------------------|---------|----------|-------|
| PLATE VOLTAGE                     | 110 max | 110 max  | volts |
| GRID-NO. 2 (SCREEN) VOLTAGE       | 110 max | 110 max  | volts |
| TOTAL ZERO-SIGNAL CATHODE CURRENT | 6* max  | 12 max   | ma    |

\*For each 1.4-volt filament section.

| Typical Operation:           | Series |      | Parallel |      |      |          |
|------------------------------|--------|------|----------|------|------|----------|
| Plate Voltage                | 90     | 110  | 85       | 90   | 110  | volts    |
| Grid-No. 2 Voltage           | 90     | 110  | 85       | 90   | 110  | volts    |
| Grid-No. 1 Voltage           | -4.5   | -6.6 | -5       | -4.5 | -6.6 | volts    |
| Peak AF Grid-No. 1 Voltage   | 4.5    | 5.1  | 5        | 4.5  | 5.4  | volts    |
| Plate Current                | 8.0    | 8.5  | 7.0      | 9.5  | 10   | ma       |
| Grid-No. 2 Current (Approx.) | 1.0    | 1.1  | 0.8      | 1.3  | 1.4  | ma       |
| Plate Resistance (Approx.)   | 0.08   | 0.11 | 0.07     | 0.09 | 0.1  | megohm   |
| Transconductance             | 2000   | 2000 | 1950     | 2200 | 2200 | μmhos    |
| Load Resistance              | 8000   | 8000 | 9000     | 8000 | 8000 | ohms     |
| Total Harmonic Distortion    | 8.5    | 8.5  | 5.5      | 6.0  | 6.0  | per cent |
| Maximum-Signal Power Output  | 230    | 330  | 250      | 270  | 400  | mw       |

**Maximum Circuit Values (For maximum rated conditions):**

|                               |  |         |         |
|-------------------------------|--|---------|---------|
| Grid-No.1-Circuit Resistance: |  |         |         |
| For fixed-bias operation      |  | 2.2 max | megohms |
| For cathode-bias operation    |  | 2.2 max | megohms |

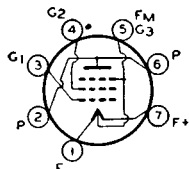

**POWER PENTODE**

**3S4**

Miniature type used in output stage of lightweight, compact, portable, battery-operated equipment. Outline 13, OUTLINES SECTION. Tube requires miniature seven-contact socket

and may be mounted in any position. Types 3S4 and 1S4 are identical except for filament arrangement. Type 3S4 features a filament mid-tap so that tube may be used either with a 1.4-volt battery supply or in series with other miniature tubes having 0.050-ampere filaments. For filament considerations, refer to type 3V4 and ELECTRON TUBE INSTALLATION SECTION.

| Filament Arrangement  | Series | Parallel |        |
|-----------------------|--------|----------|--------|
| FILAMENT VOLTAGE (DC) | 2.8    | 1.4      | volts  |
| FILAMENT CURRENT      | 0.05   | 0.1      | ampere |

**CLASS A<sub>1</sub> AMPLIFIER**

| Maximum Ratings:            | Series    | Parallel |       |
|-----------------------------|-----------|----------|-------|
| PLATE VOLTAGE               | 90 max    | 90 max   | volts |
| GRID-NO. 2 (SCREEN) VOLTAGE | 67.5 max  | 67.5 max | volts |
| TOTAL CATHODE CURRENT       | 6.0 # max | 12 max   | ma    |

# For each 1.4-volt filament section.

### Typical Operation:

|  | Series |      | Parallel |      |            |
|--|--------|------|----------|------|------------|
| Plate Voltage.....                     | 67.5   | 90   | 67.5     | 90   | volts      |
| Grid-No. 2 Voltage.....                | 67.5   | 67.5 | 67.5     | 67.5 | volts      |
| Grid-No. 1 (Control-Grid) Voltage..... | -7     | -7   | -7       | -7   | volts      |
| Peak AF Grid-No. 1 Voltage.....        | 7      | 7    | 7        | 7    | volts      |
| Zero-Signal Plate Current.....         | 6.0    | 6.1  | 7.2      | 7.4  | ma         |
| Zero-Signal Grid-No. 2 Current.....    | 1.2    | 1.1  | 1.5      | 1.4  | ma         |
| Plate Resistance.....                  | 0.1    | 0.1  | 0.1      | 0.1  | megohm     |
| Transconductance.....                  | 1400   | 1425 | 1550     | 1575 | $\mu$ mhos |
| Load Resistance.....                   | 5000   | 8000 | 5000     | 8000 | ohms       |
| Total Harmonic Distortion.....         | 12     | 13   | 10       | 12   | per cent   |
| Maximum-Signal Power Output.....       | 160    | 235  | 180      | 270  | mw         |

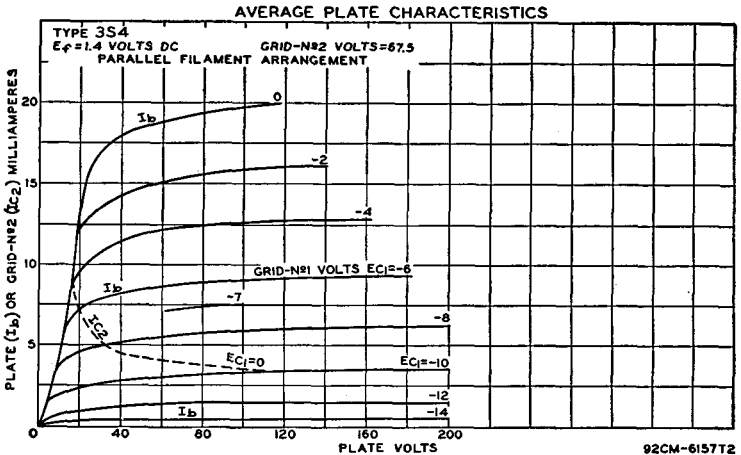

### POWER PENTODE

# 3V4

Miniature type used in output stage of lightweight, compact, portable, battery-operated equipment. Except for terminal connections, types 3V4 and 3Q4 are identical. Both feature

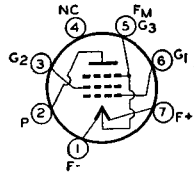

filament mid-tap so that tubes may be used either with a 1.4-volt battery supply or in series with other miniature tubes having 0.050-ampere filaments.

#### Filament Arrangement

|                            | Series | Parallel |        |
|----------------------------|--------|----------|--------|
| FILAMENT VOLTAGE (DC)..... | 2.8    | 1.4      | volts  |
| FILAMENT CURRENT.....      | 0.05   | 0.1      | ampere |

#### DIRECT INTERELECTRODE CAPACITANCES (Approx.):

|  |     |         |
|--|-----|---------|
| Grid No. 1 to Plate.....                             | 0.2 | $\mu$ f |
| Grid No.1 to Filament, Grid No.2, and Grid No.3..... | 5.5 | $\mu$ f |
| Plate to Filament, Grid No.2, and Grid No.3.....     | 3.8 | $\mu$ f |

### CLASS A<sub>1</sub> AMPLIFIER

#### Maximum Ratings:

|                                  | Series  | Parallel |       |
|----------------------------------|---------|----------|-------|
| PLATE VOLTAGE.....               | 90 max  | 90 max   | volts |
| GRID-NO. 2 (SCREEN) VOLTAGE..... | 90 max  | 90 max   | volts |
| TOTAL CATHODE CURRENT.....       | 6 # max | 12 max   | ma    |

# For each 1.4-volt filament section.

#### Typical Operation:

|  | Series | Parallel |       |
|--|--------|----------|-------|
| Plate Voltage.....                     | 90     | 85 90    | volts |
| Grid-No. 2 Voltage.....                | 90     | 85 90    | volts |
| Grid-No. 1 (Control-Grid) Voltage..... | -4.5   | -5 -4.5  | volts |



## RCA Receiving Tube Manual

|                                     |       |       |       |          |
|-------------------------------------|-------|-------|-------|----------|
| Peak AF Grid-No. 1 Voltage.....     | 4.5   | 5     | 4.5   | volts    |
| Zero-Signal Plate Current.....      | 7.7   | 6.9   | 9.5   | ma       |
| Zero-Signal Grid-No. 2 Current..... | 1.7   | 1.5   | 2.1   | ma       |
| Plate Resistance (Approx.).....     | 0.12  | 0.12  | 0.1   | megohm   |
| Transconductance.....               | 2000  | 1975  | 2150  | μmhos    |
| Load Resistance.....                | 10000 | 10000 | 10000 | ohms     |
| Total Harmonic Distortion.....      | 7     | 10    | 7     | per cent |
| Maximum-Signal Power Output.....    | 240   | 250   | 270   | mw       |

### INSTALLATION AND APPLICATION

Type 3V4 requires miniature seven-contact socket and may be mounted in any position. Outline 13, OUTLINES SECTION.

The filament power supply may be obtained from dry-cell batteries, from storage batteries, or from a power line. With dry-cell battery supply, the filament may be connected either directly across a battery rated at a terminal potential of 1.5 volts, or in series with the filaments of similar tubes across a power supply consisting of dry cells in series. In any case, the voltage across each 1.4-volt section of filament should not exceed 1.6 volts.

With power-line or storage-battery supply, the filament may be operated in series with the filaments of other tubes of the same filament-current rating. For such operation, design adjustments should be made so that, with tubes of rated characteristics operating with all electrode voltages applied and on a normal line voltage of 117 volts or on a normal storage-battery voltage of 2.0 volts per cell (without a charger) or 2.2 volts per cell (with a charger), the voltage drop across each 1.4-volt section of filament will be maintained within a range of 1.25 to 1.4 volts with a center of 1.3 volts.

For series operation of the sections, a shunting resistor must be connected across the section between the F- and  $F_m$ , the filament mid-tap, to bypass any cathode current in this section which is in excess of the rated maximum per section. When other tubes in a series-filament arrangement contribute to the filament current of the 3V4, an additional shunting resistor may be required across the entire filament (F- to F+).

For series filament arrangement, filament voltage is applied between pins No.1 and No.7. For parallel filament arrangement, filament voltage is applied between pin No.5 and pins No.1 and No.7 connected together. Refer to ELECTRON TUBE INSTALLATION SECTION for additional filament considerations.

In series filament arrangement, the grid-No.1 voltage is referred to F-. In parallel filament arrangement, the grid-No.1 voltage is referred to  $F_m$ , the filament mid-tap.

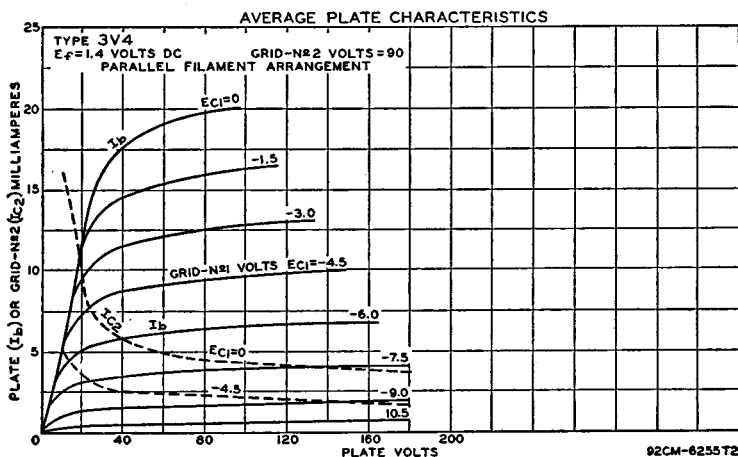

# 5AZ4

## FULL-WAVE VACUUM RECTIFIER

Lock-in type used in power supply of radio equipment having moderate dc requirements. Outline 20, OUTLINES SECTION. Tube requires lock-in socket. Filament volts, 5; amperes, 2. For maximum ratings, typical operation, and curves, refer to glass-octal type 5Y3-GT. Type 5AZ4 is used principally for renewal purposes.

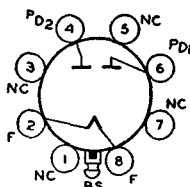

# 5T4

## FULL-WAVE VACUUM RECTIFIER

Metal type used in power supply of radio equipment having large dc requirements. Outline 7, OUTLINES SECTION. Tube requires octal socket. Vertical tube mounting is preferred but horizontal mounting is permissible if pins 2 and 8 are in vertical plane. Filament volts (ac), 5.0; amperes, 2.0. This type is used principally for renewal purposes.

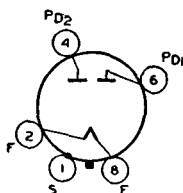

### Maximum Ratings:

### FULL-WAVE RECTIFIER

|                                 |          |       |
|---------------------------------|----------|-------|
| PEAK INVERSE PLATE VOLTAGE..... | 1550 max | volts |
| PEAK PLATE CURRENT.....         | 675 max  | ma    |
| DC OUTPUT CURRENT.....          | 225 max  | ma    |

### Typical Operation:

| Filter Input  | Capacitor | Choke |         |
|---|-----------|-------|---------|
| AC Plate-to-Plate Supply Voltage (rms) .....            | 900       | 1100  | volts   |
| Filter-Input Capacitor.....                             | 4         | -     | μf      |
| Total Effective Plate-Supply Impedance Per Plate† ..... | 150       | -     | ohms    |
| Filter-Input Choke.....                                 | -         | 10    | henries |
| DC Output Current.....                                  | 225       | 225   | ma      |
| DC Output Voltage at Input to Filter (Approx.):         |           |       |         |
| At half-load current (112.5 ma.) .....                  | 530       | 465   | volts   |
| At full-load current (225 ma.) .....                    | 480       | 450   | volts   |
| Voltage Regulation (Approx.):                           |           |       |         |
| Half-load to full-load current.....                     | 50        | 15    | volts   |

† When a filter-input capacitor larger than 40 μf is used, it may be necessary to use more plate-supply impedance than the value shown in order to limit the peak plate current to the rated value.

# 5U4-G

## FULL-WAVE VACUUM RECTIFIER

Glass octal type used in power supply of radio equipment having high dc requirements. Outline 42, OUTLINES SECTION. Tube requires octal socket. Vertical mounting is preferred

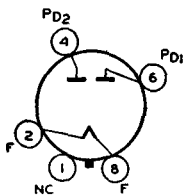

but horizontal mounting is permissible if pins 1 and 4 are in vertical plane. The coated filament is designed to operate from the ac line through a step-down transformer. The voltage at the filament terminals should be 5.0 volts under operating conditions at an average line voltage of 117 volts. It is especially important that this tube, like other power-handling tubes, be adequately ventilated. For discussion of Rating Chart and Operation Characteristics, refer to type 6AX5-GT.

|                            |     |         |
|----------------------------|-----|---------|
| FILAMENT VOLTAGE (AC)..... | 5.0 | volts   |
| FILAMENT CURRENT.....      | 3.0 | amperes |

## FULL-WAVE RECTIFIER

### Maximum Ratings:

|  |                  |         |
|--|------------------|---------|
| PEAK INVERSE PLATE VOLTAGE.....              | 1550 max         | volts   |
| PEAK PLATE CURRENT PER PLATE.....            | 675 max          | ma      |
| HOT-SWITCHING TRANSIENT PLATE CURRENT        |                  |         |
| for duration of 0.2 second maximum.....      | 2.35 max         | amperes |
| AC PLATE SUPPLY VOLTAGE PER PLATE (RMS)..... | See Rating Chart |         |
| DC OUTPUT CURRENT PER PLATE (RMS).....       | See Rating Chart |         |

### Typical Operation with Capacitor Input to Filter:

|   |     |      |         |
|---|-----|------|---------|
| AC Plate-to-Plate Supply Voltage (rms).....     | 900 | 1100 | volts   |
| Filter Input Capacitor*.....                    | 10  | 10   | $\mu$ f |
| Effective Plate-Supply Impedance Per Plate..... | 170 | 230  | ohms    |
| DC Output Voltage at Input to Filter (Approx.): |     |      |         |
| At half-load current of { 112.5 ma.....         | 510 | -    | volts   |
| { 78 ma.....                                    | -   | 660  | volts   |
| At full-load current of { 225 ma.....           | 430 | -    | volts   |
| { 156 ma.....                                   | -   | 590  | volts   |
| Voltage Regulation (Approx.):                   |     |      |         |
| Half-load to full-load current.....             | 80  | 70   | volts   |

### Typical Operation with Choke Input to Filter:

|   |      |      |         |
|---|------|------|---------|
| AC Plate-to-Plate Supply Voltage (rms).....     | 900  | 1100 | volts   |
| Filter Input Choke.....                         | 10 # | 10 # | henries |
| DC Output Voltage at Input to Filter (Approx.): |      |      |         |
| At half-load current of { 135 ma.....           | 365  | -    | volts   |
| { 112.5 ma.....                                 | -    | 460  | volts   |
| At full-load current of { 270 ma.....           | 345  | -    | volts   |
| { 225 ma.....                                   | -    | 440  | volts   |
| Voltage Regulation (Approx.):                   |      |      |         |
| Half-load to full-load current.....             | 20   | 20   | volts   |

\* Higher values of capacitance than indicated may be used but the effective plate-supply impedance may have to be increased to prevent exceeding the maximum rating for hot-switching transient plate current.

# This value is adequate to maintain optimum regulation in the region to the right of line L=10H on curve OPERATION CHARACTERISTICS with Choke Input to Filter, provided the load current is not less than 35 ma. For load currents less than 35 ma, a larger value of inductance is required for optimum regulation.

## This value is adequate to maintain optimum regulation in the region to the right of line L=10H on curve OPERATION CHARACTERISTICS with Choke Input to Filter, provided the load current is not less than 45 ma. For load currents less than 45 ma, a larger value of inductance is required for optimum regulation.

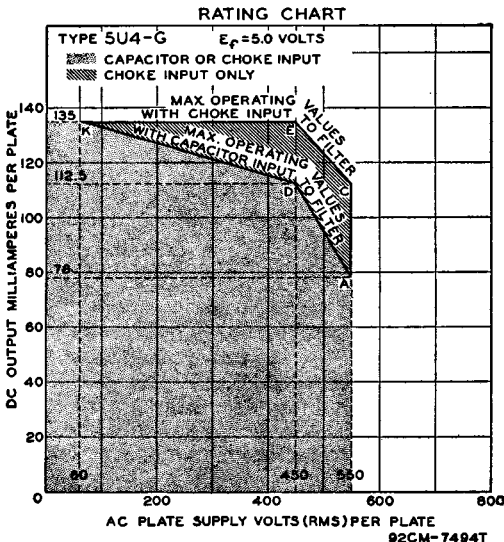

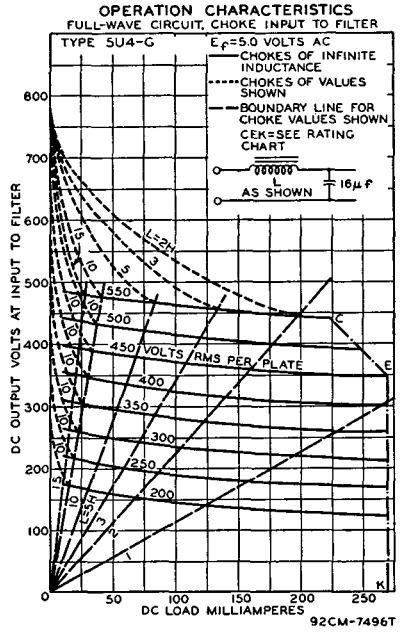
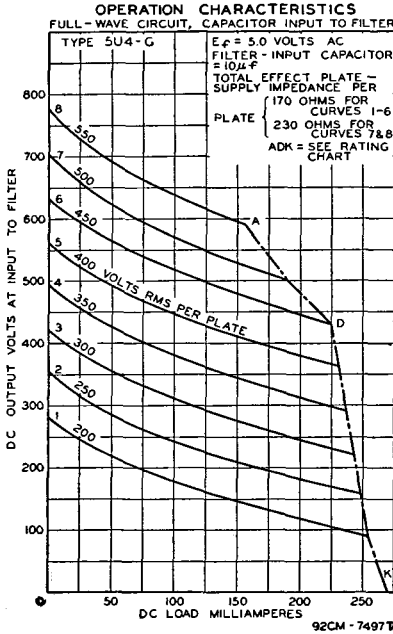

**FULL-WAVE VACUUM RECTIFIER**

**5V4-G**

Glass octal type used in power supply of radio equipment having high dc requirements. Outline 37, OUT-LINESSECTION. Tuberequires octal socket and may be mounted in any

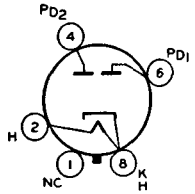

position. The heater is designed to operate from the ac line through a step-down transformer. The voltage at the heater terminals should be 5.0 volts under operating conditions at an average line voltage of 117 volts. It is especially important that this tube, like other power-handling tubes, be adequately ventilated.

|                           |     |         |
|---------------------------|-----|---------|
| HEATER VOLTAGE (AC) ..... | 5.0 | volts   |
| HEATER CURRENT .....      | 2.0 | amperes |

**Maximum Ratings:**

**FULL-WAVE RECTIFIER**

|                                    |          |       |
|------------------------------------|----------|-------|
| PEAK INVERSE PLATE VOLTAGE .....   | 1400 max | volts |
| PEAK PLATE CURRENT PER PLATE ..... | 525 max  | ma    |
| DC OUTPUT CURRENT .....            | 175 max  | ma    |

**Typical Operation:**

|   | Capacitor | Choke |               |
|---|-----------|-------|---------------|
| AC Plate-to-Plate Supply Voltage (rms) .....            | 750       | 1000  | volts         |
| Filter-Input Capacitor .....                            | 8         | -     | $\mu\text{f}$ |
| Total Effective Plate-Supply Impedance per Plate* ..... | 100       | -     | ohms          |
| Min. Filter-Input Choke .....                           | -         | 4     | henries       |
| DC Output Current .....                                 | 175       | 175   | ma            |
| <b>DC Output Voltage at Input to Filter (Approx.):</b>  |           |       |               |
| At half-load current (87.5 ma.) .....                   | 455       | 425   | volts         |
| At full-load current (175 ma.) .....                    | 415       | 415   | volts         |
| <b>Voltage Regulation (Approx.):</b>                    |           |       |               |
| Half-load to full-load current .....                    | 40        | 10    | volts         |

\* When a filter-input capacitor larger than  $40 \mu\text{f}$  is used, it may be necessary to use more plate-supply impedance than the value shown to limit the peak plate current to the rated value.

OPERATION CHARACTERISTICS

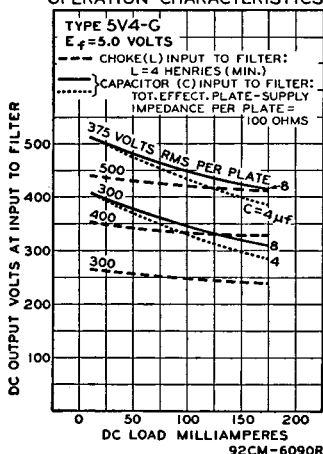

FULL-WAVE VACUUM RECTIFIER

Metal type 5W4 and glass-octal type 5W4-GT are used in power supply of radio equipment having low dc requirements. Outlines 6 and 26, respectively, OUTLINES SECTION. Both types require octal socket. Filament volts (ac), 5.0; amperes, 1.5. Maximum ratings: peak inverse plate volts, 1400 *max*; peak plate ma., 300 *max*; dc output ma., 100 *max*. The 5W4 is a DISCONTINUED type listed for reference only. Type 5W4-GT is used principally for renewal purposes.

5W4  
5W4-GT

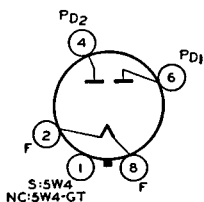

FULL-WAVE VACUUM RECTIFIER

Glass octal type used in power supply of radio equipment having large dc requirements. Outline 42, OUTLINES SECTION. Filament volts, 5.0; amperes, 3.0. Except for basing arrangement, this type is identical with type 5U4-G. Type 5X4-G is used principally for renewal purposes.

5X4-G

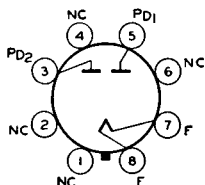

FULL-WAVE VACUUM RECTIFIER

Glass octal types used in power supply of radio equipment having moderate dc requirements. Type 5Y3-G, Outline 37; type 5Y3-GT, Outline 26, OUTLINES SECTION. Tubes require

5Y3-G  
5Y3-GT

octal socket. Vertical tube mounting is preferred, but horizontal operation is permissible if pins 2 and 8 are in horizontal plane. It is especially important that these tubes, like other power-handling tubes, be adequately ventilated. Type 5Y3-G is used principally for renewal purposes. For discussion of Rating Chart and Operation Characteristics, refer to type 6AX5-GT.

|                            |     |         |
|----------------------------|-----|---------|
| FILAMENT VOLTAGE (AC)..... | 5.0 | volts   |
| FILAMENT CURRENT.....      | 2.0 | amperes |

# RCA Receiving Tube Manual

## Maximum Ratings:

### FULL-WAVE RECTIFIER

|  |                  |         |
|--|------------------|---------|
| PEAK INVERSE PLATE VOLTAGE.....              | 1400 max         | volts   |
| PEAK PLATE CURRENT PER PLATE.....            | 400 max          | ma      |
| HOT-SWITCHING TRANSIENT PLATE CURRENT        |                  |         |
| For duration of 0.2 second maximum.....      | 2.2 max          | amperes |
| AC PLATE SUPPLY VOLTAGE PER PLATE (RMS)..... | See Rating Chart |         |
| DC OUTPUT CURRENT PER PLATE (RMS).....       | See Rating Chart |         |

## Typical Operation with Capacitor Input to Filter:

|   |     |      |       |
|---|-----|------|-------|
| AC Plate-to-Plate Supply Voltage (rms).....     | 700 | 1000 | volts |
| Filter Input Capacitor*.....                    | 10  | 10   | μf    |
| Effective Plate-Supply Impedance Per Plate..... | 50  | 140  | ohms  |
| DC Output Voltage at Input to Filter (Approx.): |     |      |       |
| At half-load current of { 62.5 ma .....         | 390 | -    | volts |
| 42 ma .....                                     | -   | 610  | volts |
| At full-load current of { 125 ma .....          | 350 | -    | volts |
| 84 ma .....                                     | -   | 560  | volts |
| Voltage Regulation (Approx.):                   |     |      |       |
| Half-load to full-load current.....             | 40  | 50   | volts |

## Typical Operation with Choke Input to Filter:

|   |     |      |         |
|---|-----|------|---------|
| AC Plate-to-Plate Supply Voltage (rms).....     | 700 | 1000 | volts   |
| Filter Input Choke.....                         | 10# | 10#  | henries |
| DC Output Voltage at Input to Filter (Approx.): |     |      |         |
| At half-load current of { 75 ma .....           | 270 | -    | volts   |
| 62.5 ma .....                                   | -   | 405  | volts   |
| At full-load current of { 150 ma .....          | 245 | -    | volts   |
| 125 ma .....                                    | -   | 390  | volts   |
| Voltage Regulation (Approx.):                   |     |      |         |
| Half-load to full-load current.....             | 25  | 15   | volts   |

\* Higher values of capacitance than indicated may be used but the effective plate supply impedance may have to be increased to prevent exceeding the maximum rating for hot-switching transient plate current.

# This value is adequate to maintain optimum regulation in the region to the right of line L=10H on curve OPERATION CHARACTERISTICS with Choke Input to Filter, provided the load current is not less than 35 ma. For load currents less than 35 ma, a larger value of inductance is required for optimum regulation.

# # This value is adequate to maintain optimum regulation in the region to the right of line L=10H on curve OPERATION CHARACTERISTICS with Choke Input to Filter, provided the load current is not less than 50 ma. For load currents less than 50 ma, a larger value of inductance is required for optimum regulation.

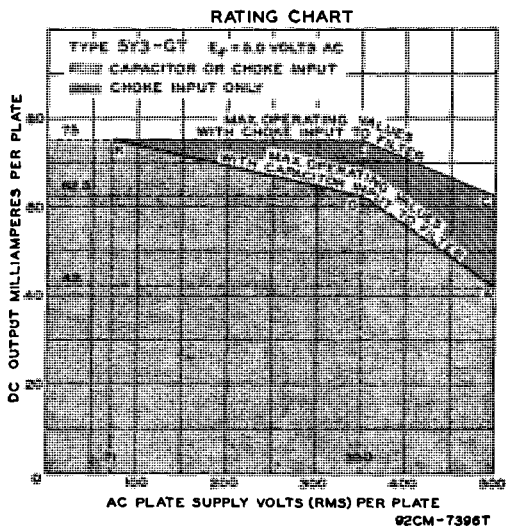

OPERATION CHARACTERISTICS

FULL-WAVE CIRCUIT, CAPACITOR INPUT TO FILTER

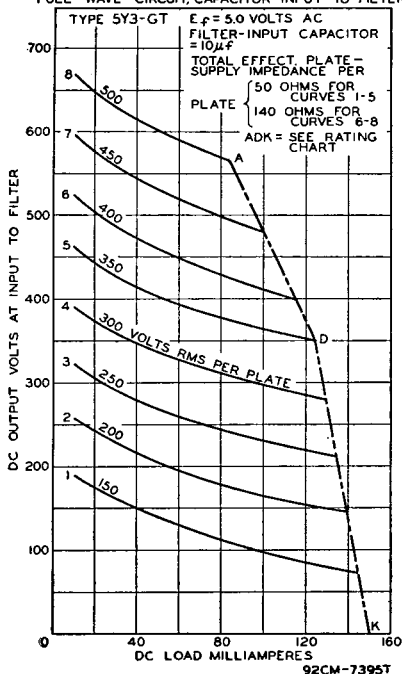

OPERATION CHARACTERISTICS

FULL-WAVE CIRCUIT, CHOKE INPUT TO FILTER

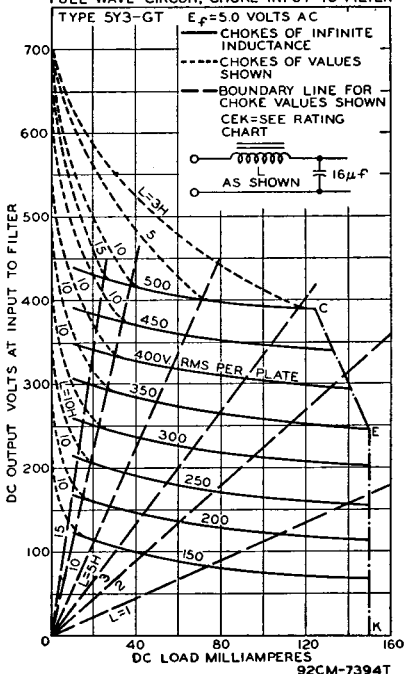

FULL-WAVE VACUUM RECTIFIER

Glass octal type used in power supply of radio equipment having moderate dc requirements. Outline 37, OUTLINES SECTION. Tube requires octal socket. Vertical tube mounting is preferred, but horizontal mounting is permissible if pins 2 and 7 are in horizontal plane. Filament volts (ac), 5.0; amperes, 2.0. For maximum ratings, typical operation, and curves, refer to type 5Y3-GT. Type 5Y4-G is used principally for renewal purposes.

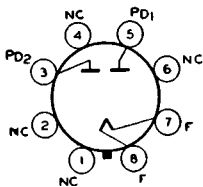

5Y4-G

FULL-WAVE VACUUM RECTIFIER

Glass type used in power supply of radio equipment having large dc requirements. Outline 43, OUTLINES SECTION. Tube requires four-contact socket. Vertical mounting is preferred but horizontal mounting is permissible if pins 1 and 4 are in horizontal plane. Filament volts (ac), 5.0; amperes, 3.0. For maximum ratings, typical operation, and curves, refer to type 5U4-G. Type 5Z3 is used principally for renewal purposes.

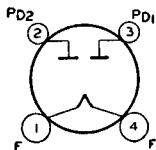

5Z3

FULL-WAVE VACUUM RECTIFIER

Metal type used in power supply of radio equipment having moderate dc requirements. Outline 6, OUTLINES SECTION. Tube requires octal socket and may be mounted in any position. Heater volts (ac), 5.0; amperes, 2.0. Maximum ratings: peak inverse plate volts, 1400 max; peak plate ma. per plate, 375 max. Typical operation as full-wave rectifier with capacitor-input filter: ac plate-to-plate supply

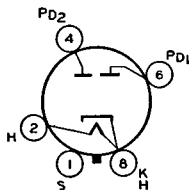

5Z4

volts (rms), 700; total effective plate-supply impedance per plate, 50 ohms; dc output ma., 125. Typical operation with choke-input filter: ac plate-to-plate supply volts, 1000; minimum filter-input choke, 5 henries; dc output ma., 125.

**6A3**

**POWER TRIODE**

Glass type used in output stage of radio receivers. Outline 43, OUTLINES SECTION. Tube requires four-contact socket. Filament volts (ac/dc), 6.3; amperes, 1.0. This type is identical electrically with type 6B4-G. Type 6A3 is a DISCONTINUED type listed for reference only.

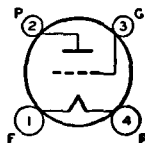

**6A4/LA**

**POWER PENTODE**

Glass type used in output stage of automobile receivers. Outline 38, OUTLINES SECTION. Tube requires five-contact socket. Filament volts (ac/dc), 6.3; amperes, 0.3. Typical operation: plate and grid-No. 2 volts, 180 max; grid-No. 1 volts, -12; plate ma., 22; grid-No. 2 ma., 3.9; plate resistance, 45500 ohms approx.; transconductance, 2200  $\mu$ mhos; load resistance, 8000 ohms; cathode-bias resistor, 465 ohms; output watts, 1.4. This is a DISCONTINUED type listed for reference only.

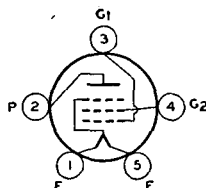

**6A6**

**HIGH-MU TWIN POWER TRIODE**

Glass type used in output stage of ac-operated receivers as a class B power amplifier or with units in parallel as a class A<sub>1</sub> amplifier to drive a 6A6 as class B amplifier. Outline 38, OUTLINES SECTION. Tube requires medium seven-contact (0.855-inch, pin-circle diameter) socket. Filament volts (ac/dc), 6.3; amperes, 0.8. This type is electrically identical with type 6N7. Type 6A6 is a DISCONTINUED type listed for reference only.

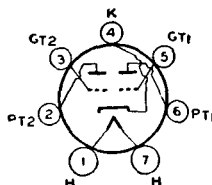

**6A7**

**PENTAGRID CONVERTER**

Glass types used in superheterodyne circuits. Outline 36, OUTLINES SECTION. These types require the small seven-contact (0.75-inch, pin-circle diameter) socket. Except for interelectrode capacitances, the 6A7 is identical electrically with type 6A8. Type 6A7S, now DISCONTINUED, has the external shield connected to cathode. In general, its electrical characteristics are similar to those of the 6A7, but

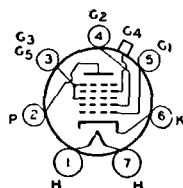

the two types are usually not directly interchangeable. Type 6A7 is used principally for renewal purposes.

**6A7S**

**PENTAGRID CONVERTER**

Metal type 6A8 and glass-octal types 6A8-G and 6A8-GT used in superheterodyne circuits. Types 6A8, Outline 4; type 6A8-G, Outline 35; type 6A8-GT, Outline 24, OUTLINES SECTION. These types are used principally for renewal purposes. All require octal socket. For general discussion of pentagrid types, see Frequency Conversion in ELECTRON TUBE APPLICATIONS SECTION. For heater and cathode considerations, refer to type 6AV6.

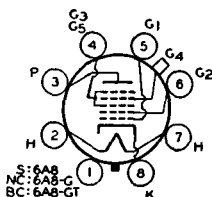

**6A8**  
**6A8-G**  
**6A8-GT**

HEATER VOLTAGE (AC/DC).....  
HEATER CURRENT.....

6.3 volts  
0.3 ampere



**Maximum Ratings:**
**CONVERTER SERVICE**

|   |                 |       |
|---|-----------------|-------|
| PLATE VOLTAGE.....  | 300 <i>max</i>  | volts |
| GRIDS-NO. 3-AND-NO. 5 (SCREEN) VOLTAGE.....                 | 100 <i>max</i>  | volts |
| GRIDS-NO. 3-AND-NO. 5 SUPPLY VOLTAGE.....                   | 300 <i>max</i>  | volts |
| GRID-NO. 2 (ANODE-GRID) VOLTAGE.....                        | 200 <i>max</i>  | volts |
| GRID-NO. 2 SUPPLY VOLTAGE.....                              | 300 <i>max</i>  | volts |
| GRID-NO. 4 (CONTROL-GRID) VOLTAGE, Positive Bias Value..... | 0 <i>max</i>    | volts |
| PLATE DISSIPATION.....                                      | 1.0 <i>max</i>  | watt  |
| GRIDS-NO.3-AND-NO.5 INPUT.....                              | 0.3 <i>max</i>  | watt  |
| GRID-NO.2 INPUT.....  | 0.75 <i>max</i> | watt  |
| TOTAL CATHODE CURRENT.....                                  | 14 <i>max</i>   | ma    |
| <b>PEAK HEATER-CATHODE VOLTAGE:</b>                         |                 |       |
| Heater negative with respect to cathode.....                | 90 <i>max</i>   | volts |
| Heater positive with respect to cathode.....                | 90 <i>max</i>   | volts |

**Typical Operation:**

|  |       |       |            |
|--|-------|-------|------------|
| Plate Voltage.....   | 100   | 250   | volts      |
| Grids-No. 3-and-No. 5 Voltage.....   | 50    | 100   | volts      |
| Grid-No. 2 Voltage.....  | 100   | -     | volts      |
| Grid-No. 2 Supply Voltage.....   | -     | 250*  | volts      |
| Grid-No. 4 Voltage.....  | -1.5  | -3    | volts      |
| Grid-No. 1 (Oscillator-Grid) Resistor.....                                     | 50000 | 50000 | ohms       |
| Plate Resistance (Approx.).....  | 0.6   | 0.36  | megohm     |
| Conversion Transconductance.....   | 360   | 550   | $\mu$ mhos |
| Conversion Transconductance (Approx.) with control-grid bias of -20 volts..... | 3     | -     | $\mu$ mhos |
| Conversion Transconductance (Approx.) with control-grid bias of -35 volts..... | -     | 6     | $\mu$ mhos |
| Plate Current.....   | 1.1   | 3.5   | ma         |
| Grids-No. 3-and-No. 5 Current.....   | 1.3   | 2.7   | ma         |
| Grid-No. 2 Current.....  | 2     | 4     | ma         |
| Grid-No. 1 Current.....  | 0.25  | 0.4   | ma         |
| Total Cathode Current.....   | 4.6   | 10.6  | ma         |

\* Grid-No. 2 supply voltages in excess of 200 volts require use of 20000-ohm voltage-dropping resistor bypassed by 0.1- $\mu$ f capacitor.

## HIGH-MU TRIODE

Miniature type used as cathode-drive amplifier, frequency converter, or oscillator at frequencies up to about 300 megacycles per second particularly in television and FM receivers. Out-

# 6AB4

line 13, **OUTLINES SECTION**. Tube requires miniature seven-contact socket and may be mounted in any position. For maximum ratings, characteristics, and curves, refer to type 12AT7. For heater and cathode considerations, refer to type 6AV6.

|  |      |         |
|--|------|---------|
| HEATER VOLTAGE (AC/DC).....                        | 6.3  | volts   |
| HEATER CURRENT.....                                | 0.15 | ampere  |
| <b>DIRECT INTERELECTRODE CAPACITANCES:</b>         |      |         |
| Grid to Plate.....                                 | 1.5  | $\mu$ f |
| Grid to Cathode, Heater, and Internal Shield.....  | 2.2  | $\mu$ f |
| Plate to Cathode, Heater, and Internal Shield..... | 0.5  | $\mu$ f |
| Heater to Cathode.....                             | 2.9  | $\mu$ f |
| Plate to Cathode.....                              | 0.24 | $\mu$ f |
| Cathode to Grid, Heater, and Internal Shield.....  | 5.0  | $\mu$ f |
| Plate to Grid, Heater, and Internal Shield.....    | 1.7  | $\mu$ f |

**Maximum Ratings:**
**CLASS A<sub>1</sub> AMPLIFIER**

|  |                |       |
|--|----------------|-------|
| PLATE VOLTAGE.....                           | 300 <i>max</i> | volts |
| PLATE DISSIPATION.....                       | 2.5 <i>max</i> | watts |
| GRID VOLTAGE, Negative Bias Value.....       | -50 <i>max</i> | volts |
| <b>PEAK HEATER-CATHODE VOLTAGE:</b>          |                |       |
| Heater negative with respect to cathode..... | 90 <i>max</i>  | volts |
| Heater positive with respect to cathode..... | 90 <i>max</i>  | volts |

**Characteristics:**

|  |                     |       |            |
|--|---------------------|-------|------------|
| Plate Voltage.....                                       | 100                 | 250   | volts      |
| Internal Shield.....                                     | Connected to ground |       |            |
| Cathode Resistor.....                                    | 270                 | 200   | ohms       |
| Amplification Factor.....                                | 60                  | 60    |            |
| Plate Resistance (Approx.).....                          | 15000               | 10900 | ohms       |
| Transconductance.....                                    | 4000                | 5500  | $\mu$ mhos |
| Grid Bias (Approx.) for plate current of 10 $\mu$ a..... | -5                  | -12   | volts      |
| Plate Current.....                                       | 3.7                 | 10    | ma         |

**ELECTRON-RAY TUBE**

**6AB5/  
6N5**

Glass type used to indicate visually by means of a fluorescent target the effects of a change in a controlling voltage. It is used as a convenient means of indicating accurate radio-receiver tuning. Outline 31, OUTLINES SECTION. Tube requires six-contact socket. For heater and cathode considerations, refer to type 6AV6. Heater volts (ac/dc), 6.3; amperes, 0.15. Ratings: plate-supply volts, 180 *max*; target volts, 180 *max*, 125 *min*. This type is used principally for renewal purposes.

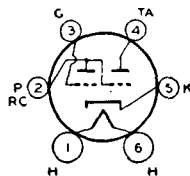

**REMOTE-CUTOFF PENTODE**

**6AB7**

Metal type used in rf and if stages of picture amplifier of television receivers particularly those employing automatic-gain control. Outline 3, OUTLINES SECTION. Tube requires octal socket. Heater volts (ac/dc), 6.3; amperes, 0.45. Maximum ratings as class A<sub>1</sub> amplifier: plate and grid-No. 2 supply volts, 300 *max*; grid-No.2 volts, 200 *max*; plate dissipation, 3.75 *max* watts; grid-No.2 input, 0.7 *max* watt. Typical operation: plate and grid-No.2 supply volts, 300; grid-No.3 volts, 0; grid-No.2 series resistor, 30000 ohms; grid-No.1 volts, -3; plate resistance (approx.), 0.7 megohm; transconductance, 5000  $\mu$ mhos; grid-No.1 volts for transconductance of 50  $\mu$ mhos, -15; plate ma., 12.5; grid-No.2 ma., 3.2. This type is used principally for renewal purposes.

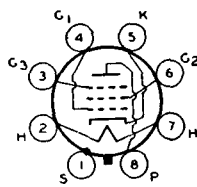

ical operation: plate and grid-No.2 supply volts, 300; grid-No.3 volts, 0; grid-No.2 series resistor, 30000 ohms; grid-No.1 volts, -3; plate resistance (approx.), 0.7 megohm; transconductance, 5000  $\mu$ mhos; grid-No.1 volts for transconductance of 50  $\mu$ mhos, -15; plate ma., 12.5; grid-No.2 ma., 3.2. This type is used principally for renewal purposes.

**HIGH-MU POWER TRIODE**

**6AC5-GT**

Glass octal type used in single-ended or push-pull audio-frequency power amplifiers of the direct-coupled type in which a driver tube develops positive grid bias for the 6AC5-GT output stage. Outline 23, OUTLINES SECTION. This type may be supplied with pin No. 1 omitted. Tube requires octal socket. Heater

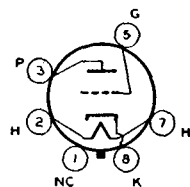

volts (ac/dc), 6.3; amperes, 0.4. Maximum ratings: plate volts, 250 *max*; peak plate ma. (per tube), 110 *max*; average plate dissipation, 10 *max* watts. This type is used principally for renewal purposes.

**SHARP-CUTOFF PENTODE**

**6AC7**

Metal type used in rf and if stages of picture amplifier and the first stages of the video amplifier of television receivers. It is also used as a mixer or oscillator tube in low-frequency applications. Outline 3, OUTLINES SECTION. Tube requires octal socket. When tube is used as a high-gain audio amplifier, heater should be operated from a battery source. For other heater considerations, refer to type 6AQ5.

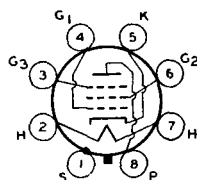

|   |                  |         |
|---|------------------|---------|
| HEATER VOLTAGE (AC/DC) .....  | 6.3              | volts   |
| HEATER CURRENT .....  | 0.45             | ampere  |
| DIRECT INTERELECTRODE CAPACITANCES:                                 |                  |         |
| Grid No.1 to Plate .....  | 0.015 <i>max</i> | $\mu$ f |
| Grid No.1 to Cathode, Heater, Grid No.2, Grid No.3, and Shell ..... | 11               | $\mu$ f |
| Plate to Cathode, Heater, Grid No.2, Grid No.3, and Shell .....     | 5                | $\mu$ f |

|  |                                      |       |
|--|--------------------------------------|-------|
| <b>Maximum Ratings:</b>                                | <b>CLASS A<sub>1</sub> AMPLIFIER</b> |       |
| PLATE VOLTAGE .....                                    | 300 <i>max</i>                       | volts |
| GRID-NO.2 (SCREEN) VOLTAGE .....                       | See curve page 64                    |       |
| GRID-NO.2 SUPPLY VOLTAGE .....                         | 300 <i>max</i>                       | volts |
| PLATE DISSIPATION .....                                | 3 <i>max</i>                         | watts |
| GRID-NO.2 INPUT:                                       |                                      |       |
| For grid-No.2 voltages up to 150 volts .....           | 0.4 <i>max</i>                       | watt  |
| For grid-No.2 voltages between 150 and 300 volts ..... | See curve page 64                    |       |
| PEAK HEATER-CATHODE VOLTAGE:                           |                                      |       |
| Heater negative with respect to cathode .....          | 90 <i>max</i>                        | volts |
| Heater positive with respect to cathode .....          | 90 <i>max</i>                        | volts |

## Typical Operation:

|                            |      |       |        |
|----------------------------|------|-------|--------|
| Plate Voltage              | 300  | 300   | volts  |
| Grid-No. 3 Voltage         | 0    | 0     | volts  |
| Grid-No. 2 Supply Voltage  | 150  | 300 # | volts  |
| Grid-No. 2 Series Resistor | -    | 60000 | ohms   |
| Min. Cathode-Bias Resistor | 160  | 160   | ohms   |
| Plate Resistance (Approx.) | 1    | 1     | megohm |
| Transconductance           | 9000 | 9000  | μmhos  |
| Plate Current              | 10   | 10    | ma     |
| Grid-No. 2 Current         | 2.5  | 2.5   | ma     |

## Maximum Circuit Values:

### Grid-No.1-Circuit Resistance:

|   |          |        |
|---|----------|--------|
| For cathode-bias operation with fixed grid-No.2 voltage | 0.25 max | megohm |
| For cathode-bias operation with grid-No.2 resistor      | 0.50 max | megohm |

# Grid-No.2 supply voltages in excess of 150 volts require use of a series dropping resistor to limit the voltage at grid No. 2 to 150 volts when the plate current is at its normal value of 10 milliamperes.

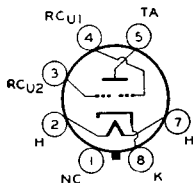

## ELECTRON-RAY TUBE

Glass octal type used to indicate visually, by means of two shadows on the fluorescent target, the effects of changes in the controlling voltages. It is a twin-indicator type and is used as a convenient means of indicating accurate radio-receiver tuning. Heater volts (ac/dc), 6.3; amperes, 0.15. Maximum target volts, 150. This is a DISCONTINUED type listed for reference only.

## 6AD6-G

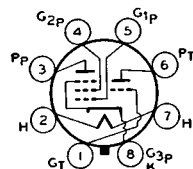

## TRIODE—POWER PENTODE

Glass octal type used in a push-pull amplifier circuit in conjunction with type 6F6-G. Triode unit serves as phase inverter. Outline 37, OUTLINES SECTION. Tube requires octal socket. Heater volts (ac/dc), 6.3; amperes, 0.85. For typical operation of pentode unit, refer to type 6F6-G. Maximum ratings of pentode unit as class A<sub>1</sub> or push-pull class AB<sub>1</sub> amplifier: plate volts, 375 max; grid-No. 2 volts, 285 max; plate

## 6AD7-G

dissipation, 8.5 max watts; grid-No.2 input, 2.7 max watts. Maximum ratings of triode unit as class A<sub>1</sub> amplifier: plate volts, 285 max; plate dissipation, 1.0 max watt. This type is used principally for renewal purposes.

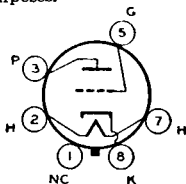

## LOW-MU TRIODE

Glass octal type used as class A<sub>1</sub> amplifier in ac/dc radio receivers. Outline 23, OUTLINES SECTION. Heater volts (ac/dc), 6.3; amperes, 0.3. Maximum ratings as class A<sub>1</sub> amplifier: plate volts, 300 max; plate dissipation, 2.5 max watts. This is a DISCONTINUED type listed for reference only.

## 6AE5-GT

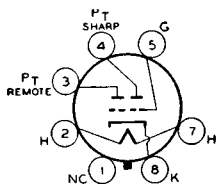

## TWIN-PLATE CONTROL TUBE

Glass octal type used as a control tube for twin-indicator type electron-ray tubes. Outline 33, OUTLINES SECTION. Contains two triodes with different cutoff characteristics. If ave voltage is applied to the common control grid in suitable circuit, one triode section operates on weak signals while the other operates on strong signals. Heater voltage (ac/dc), 6.3; amperes, 0.15. This is a DISCONTINUED type listed for reference only.

## 6AE6-G

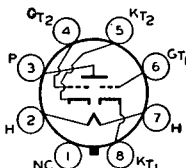

## TWIN-INPUT TRIODE

Glass octal type used as a voltage amplifier or as a driver for two type 6AC5-GT tubes in dynamic-coupled, push-pull amplifiers. In the latter service, type 6AE7-GT replaces two tubes ordinarily required as drivers. Outline 23, OUTLINES SECTION. Heater volts (ac/dc), 6.3; amperes, 0.5. This is a DISCONTINUED type listed for reference only.

## 6AE7-GT

**UHF OSCILLATOR TRIODE**

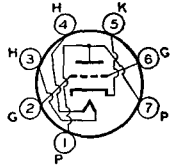

**6AF4**

Miniature type used as local oscillator in uhf television receivers covering the frequency range of 470 to 890 megacycles per second. Outline 13, OUTLINES SECTION. Tube requires

miniature seven-contact socket and may be mounted in any position.

|                                     |       |                  |
|-------------------------------------|-------|------------------|
| HEATER VOLTAGE (AC/DC).....         | 6.3   | volts            |
| HEATER CURRENT.....                 | 0.225 | ampere           |
| DIRECT INTERELECTRODE CAPACITANCES: |       |                  |
| Grid to Plate.....                  | 1.9   | $\mu\mu\text{f}$ |
| Grid to Cathode and Heater.....     | 2.2   | $\mu\mu\text{f}$ |
| Plate to Cathode and Heater.....    | 0.45  | $\mu\mu\text{f}$ |

|                            |                                      |                       |
|----------------------------|--------------------------------------|-----------------------|
| <b>Characteristics:</b>    | <b>CLASS A<sub>1</sub> AMPLIFIER</b> |                       |
| Plate Voltage.....         | 80                                   | 100 volts             |
| Cathode-Bias Resistor..... | 150                                  | 150 ohms              |
| Amplification Factor.....  | 15                                   | 16                    |
| Plate Resistance.....      | 2270                                 | 2130 ohms             |
| Transconductance.....      | 6600                                 | 7500 $\mu\text{mhos}$ |
| Plate Current.....         | 16                                   | 20 ma                 |

**Maximum Ratings: OSCILLATOR IN UHF TELEVISION RECEIVERS**

|  |          |       |
|--|----------|-------|
| DC PLATE VOLTAGE.....                        | 150 max  | volts |
| DC GRID VOLTAGE.....                         | -50 max  | volts |
| DC GRID CURRENT.....                         | 8 max    | ma    |
| PLATE INPUT.....                             | 2.5 max  | watts |
| PLATE DISSIPATION.....                       | 2.25 max | watts |
| DC CATHODE CURRENT.....                      | 28 max   | ma    |
| <b>PEAK HEATER-CATHODE VOLTAGE:*</b>         |          |       |
| Heater negative with respect to cathode..... | 50 max   | volts |
| Heater positive with respect to cathode..... | 50 max   | volts |

**Typical Operation as Oscillator at 950 Mc:**

|                                |       |               |
|--------------------------------|-------|---------------|
| DC Plate Voltage.....          | 100   | volts         |
| DC Grid Voltage.....           | -4    | volts         |
| From a grid resistor of.....   | 10000 | ohms          |
| DC Plate Current.....          | 22    | ma            |
| DC Grid Current (Approx.)..... | 400   | $\mu\text{a}$ |
| Useful Power Output.....       | 160   | mw            |

**Maximum Circuit Values:**

|                                 |                 |
|---------------------------------|-----------------|
| <b>Grid-Circuit Resistance:</b> |                 |
| For fixed-bias operation.....   | Not recommended |
| For cathode-bias operation..... | 0.5 max megohm  |

\* It is recommended that the heater be kept at cathode potential to minimize the effects of variation in the heater-to-cathode capacitance between tubes.

**AVERAGE PLATE CHARACTERISTICS**

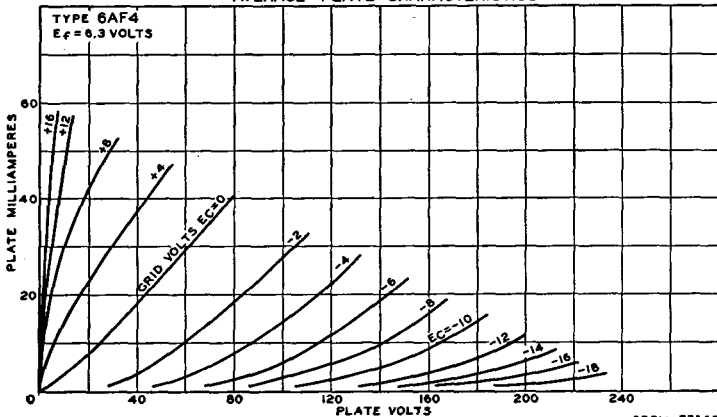

92CM-7756T

**ELECTRON-RAY TUBE**

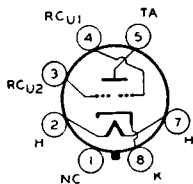

Glass octal type used to indicate visually, by means of two shadows on the fluorescent target, the effects of changes in the controlling voltages. It is a twin-indicator type and is used as a convenient means of indicating accurate radio-receiver tuning. Outline 12, OUTLINES SECTION. This type may be supplied with pin No.1 omitted. Tube requires octal socket.

**6AF6-G**

Heater volts (ac/dc), 6.3; amperes, 0.15. Ratings: target volts, 250 max, 125 min; ray-control-electrode supply volts, 250 max; peak heater-cathode volts, 90 max. Typical operation: target volts, 250; target ma., 2.2; series resistor, 1 megohm; ray-control electrode volts (approx. for 0° shadow angle), 160; ray-control electrode volts (approx. for 90° shadow angle), 0.

**SHARP-CUTOFF PENTODE**

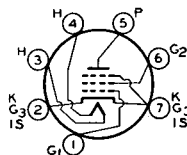

Miniature type used in compact radio equipment as an rf or if amplifier up to 400 megacycles per second. Outline 13, OUTLINES SECTION. Tube requires miniature seven-contact socket and may be mounted in any position. The two cathode leads facilitate isolation of the input and output circuits thus helping to minimize degeneration. For heater and cathode considerations, refer to type 6AV6.

**6AG5**

contact socket and may be mounted in any position. The two cathode leads facilitate isolation of the input and output circuits thus helping to minimize degeneration. For heater and cathode considerations, refer to type 6AV6.

|   |           |        |
|---|-----------|--------|
| HEATER VOLTAGE (AC/DC).....   | 6.3       | volts  |
| HEATER CURRENT.....   | 0.3       | ampere |
| DIRECT INTERELECTRODE CAPACITANCES:                                     |           |        |
| Grid No. 1 to Plate.....  | 0.030 max | μf     |
| Grid No.1 to Cathode, Heater, Grid No.2, Grid No.3, and Internal Shield | 6.5       | μf     |
| Plate to Cathode, Heater, Grid No.2, Grid No.3, and Internal Shield.... | 1.8       | μf     |

**Maximum Ratings: CLASS A<sub>1</sub> AMPLIFIER**

|   |                   |       |
|---|-------------------|-------|
| PLATE VOLTAGE.....                                    | 300 max           | volts |
| GRID-NO. 2 (SCREEN) VOLTAGE.....                      | See curve page 64 |       |
| GRID-NO.2 SUPPLY VOLTAGE.....                         | 300 max           | volts |
| PLATE DISSIPATION.....                                | 2 max             | watts |
| GRID-NO.2 INPUT:                                      |                   |       |
| For grid-No.2 voltages up to 150 volts.....           | 0.5 max           | watt  |
| For grid-No.2 voltages between 150 and 300 volts..... | See curve page 64 |       |
| PEAK HEATER-CATHODE VOLTAGE:                          |                   |       |
| Heater negative with respect to cathode.....          | 90 max            | volts |
| Heater positive with respect to cathode.....          | 90 max            | volts |

AVERAGE PLATE CHARACTERISTICS  
PENTODE CONNECTION

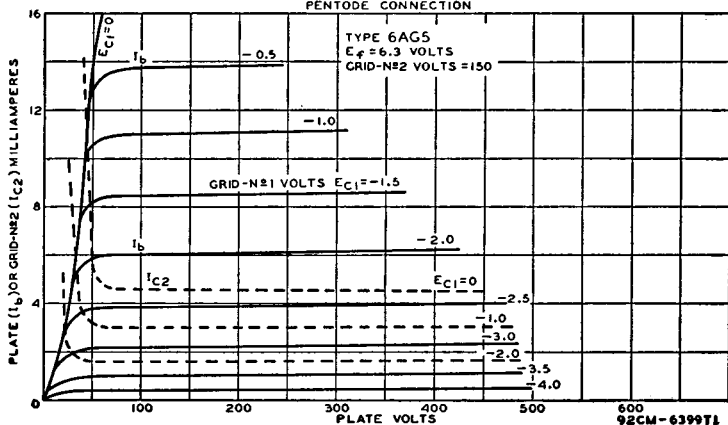

## Typical Operation:

|  |      |      |      |           |
|--|------|------|------|-----------|
| Plate Voltage                                  | 100  | 125  | 250  | volts     |
| Grid-No. 2 Voltage                             | 100  | 125  | 150  | volts     |
| Cathode-Bias Resistor                          | 180  | 100  | 180  | ohms      |
| Plate Resistance (Approx.)                     | 0.6  | 0.5  | 0.8  | megohm    |
| Transconductance                               | 4500 | 5100 | 5000 | $\mu$ hos |
| Grid-No.1 Bias for plate current of 10 $\mu$ a | -5   | -6   | -8   | volts     |
| Plate Current                                  | 4.5  | 7.2  | 6.5  | ma        |
| Grid-No. 2 Current                             | 1.4  | 2.1  | 2    | ma        |

## Maximum Ratings (Triode Connection):\*

|                   |         |       |
|-------------------|---------|-------|
| PLATE VOLTAGE     | 300 max | volts |
| PLATE DISSIPATION | 2.6 max | watts |

## Typical Operation (Triode Connection):\*

|                       |      |       |           |
|-----------------------|------|-------|-----------|
| Plate Voltage         | 180  | 250   | volts     |
| Cathode-Bias Resistor | 330  | 820   | ohms      |
| Plate Resistance      | 8000 | 10000 | ohms      |
| Amplification Factor  | 45   | 42    |           |
| Transconductance      | 5700 | 3800  | $\mu$ hos |
| Plate Current         | 7.0  | 5.5   | ma        |

\*Grid No. 2 tied to plate.

## POWER PENTODE

Metal type used in output stage of video amplifier of television receivers. Outline 6, OUTLINES SECTION. Tube requires octal socket. Heater volts (ac/dc), 6.3; amperes, 0.65. Maximum ratings as class A<sub>1</sub> video voltage amplifier: plate volts, 300 max; grid-No. 2 volts, 300 max; plate dissipation, 9.0 max watts; grid-No. 2 input, 1.5 max watts. Typical operation as a class A<sub>1</sub> amplifier: plate volts, 300; grid-No. 2

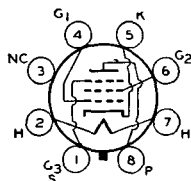

## 6AG7

volts, 150; grid-No. 1 volts, -3; peak of grid-No. 1 volts, 3; zero-signal plate ma., 30; maximum-signal plate ma., 30.5; zero-signal grid-No. 2 ma., 7; maximum-signal grid-No. 2 ma., 9; plate resistance, 13000 ohms; transconductance, 11000  $\mu$ hos; load resistance 10000 ohms; total harmonic distortion, 7 per cent; maximum-signal output watts, 3.

## MEDIUM-MU TRIODE

Glass octal type having high permeance used as vertical deflection amplifier in television receivers. Outline 22, OUTLINES SECTION. Tube requires octal socket and may be mounted in any position.

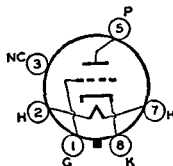

## 6AH4-GT

|                                     |      |          |
|-------------------------------------|------|----------|
| HEATER VOLTAGE (AC/DC)              | 6.3  | volts    |
| HEATER CURRENT                      | 0.75 | ampere   |
| DIRECT INTERELECTRODE CAPACITANCES: |      |          |
| Grid to Plate                       | 4.4  | $\mu$ uf |
| Grid to Cathode and Heater          | 7.0  | $\mu$ uf |
| Plate to Cathode and Heater         | 1.7  | $\mu$ uf |

## Characteristics:

### CLASS A<sub>1</sub> AMPLIFIER

|   |      |           |
|---|------|-----------|
| Plate Voltage                                 | 250  | volts     |
| Grid Voltage                                  | -23  | volts     |
| Plate Current                                 | 30   | ma        |
| Amplification Factor                          | 8    |           |
| Plate Resistance (Approx.)                    | 1780 | ohms      |
| Transconductance                              | 4500 | $\mu$ hos |
| Grid Voltage for Plate Current of 5.0 ma      | -33  | volts     |
| Grid Voltage for Plate Current of 0.5 $\mu$ a | -40  | volts     |

### VERTICAL DEFLECTION AMPLIFIER

*For operation in a 525-line, 30-frame system*

|   |          |       |
|---|----------|-------|
| DC PLATE VOLTAGE                                      | 500 max  | volts |
| PEAK POSITIVE-PULSE PLATE VOLTAGE# (Absolute maximum) | 2000 max | volts |
| PEAK NEGATIVE-PULSE GRID VOLTAGE                      | -200 max | volts |
| CATHODE CURRENT:                                      |          |       |
| Peak  | 180 max  | ma    |
| DC  | 60 max   | ma    |
| PLATE DISSIPATION                                     | 7.5 max  | watts |

# RCA Receiving Tube Manual

**PEAK HEATER-CATHODE VOLTAGE:**

|  |                |       |
|--|----------------|-------|
| Heater negative with respect to cathode..... | 200 <i>max</i> | volts |
| Heater positive with respect to cathode..... | 200 <i>max</i> | volts |

**Maximum Circuit Value (For maximum rated conditions):**

|                                  |                |         |
|----------------------------------|----------------|---------|
| Grid-Circuit Resistance:         |                |         |
| For cathode-bias operation ..... | 2.2 <i>max</i> | megohms |

# The duration of the voltage pulse must not exceed 15 per cent of one vertical scanning cycle. In a 525-line, 30-frame system, 15 per cent of one vertical scanning cycle is 2.5 milliseconds.

° Under no circumstances should this absolute value be exceeded.

■ The dc component must not exceed 100 volts.

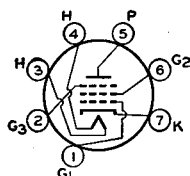

## SHARP-CUTOFF PENTODE

Miniature type used in the intermediate-frequency stages of the picture amplifier and the first stages of the video amplifier of television receivers. Outline 13, OUTLINES SECTION.

# 6AH6

Tube requires miniature seven-contact socket and may be mounted in any position. For heater and cathode considerations, refer to type 6AQ5.

|   |                  |               |
|---|------------------|---------------|
| HEATER VOLTAGE (AC/DC).....                                 | 6.3              | volts         |
| HEATER CURRENT.....   | 0.45             | ampere        |
| <b>DIRECT INTERELECTRODE CAPACITANCES:</b>                  |                  |               |
| Grid No.1 to Plate.....                                     | 0.030 <i>max</i> | $\mu\text{f}$ |
| Grid No.1 to Cathode, Heater, Grid No.2, and Grid No.3..... | 10               | $\mu\text{f}$ |
| Plate to Cathode, Heater, Grid No.2, and Grid No.3.....     | 2                | $\mu\text{f}$ |

**Maximum Ratings:**

|   |                |                   |
|---|----------------|-------------------|
| PLATE VOLTAGE.....                                    | 300 <i>max</i> | volts             |
| GRID-NO.2 (SCREEN) VOLTAGE.....                       |                | See curve page 64 |
| GRID-NO.2 SUPPLY VOLTAGE.....                         | 300 <i>max</i> | volts             |
| PLATE DISSIPATION.....                                | 3.2 <i>max</i> | watts             |
| <b>GRID-NO.2 INPUT:</b>                               |                |                   |
| For grid-No.2 voltages up to 150 volts.....           | 0.4 <i>max</i> | watt              |
| For grid-No.2 voltages between 150 and 300 volts..... |                | See curve page 64 |
| TOTAL CATHODE CURRENT.....                            | 13 <i>max</i>  | ma                |
| <b>PEAK HEATER-CATHODE VOLTAGE:</b>                   |                |                   |
| Heater negative with respect to cathode.....          | 90 <i>max</i>  | volts             |
| Heater positive with respect to cathode.....          | 90 <i>max</i>  | volts             |

## CLASS A<sub>1</sub> AMPLIFIER

**Typical Operation and Characteristics:**

|  | Triode*<br>Connection | Pentode<br>Connection          |       |
|--|-----------------------|--------------------------------|-------|
| Plate Voltage.....   | 150                   | 300                            | volts |
| Grid-No.3 (Suppressor).....  | -                     | Connected to cathode at socket |       |
| Grid-No.2 Voltage.....   | -                     | 150                            | volts |
| Cathode Resistor.....  | 160                   | 160                            | ohms  |
| Amplification Factor.....  | 40                    | -                              |       |
| Plate Resistance (Approx.).....                                      | 3600                  | 500000                         | ohms  |
| Transconductance.....  | 11000                 | 9000                           | mhos  |
| Grid-No.1 Bias (Approx.) for plate current of 10 $\mu\text{a}$ ..... | -7                    | -7                             | volts |
| Plate Current.....   | 12.5                  | 10                             | ma    |
| Grid-No.2 Current.....   | -                     | 2.5                            | ma    |

\* Grid No.2 and Grid No.3 tied to plate.

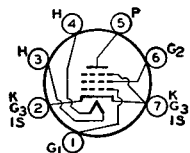

## SHARP-CUTOFF PENTODE

Miniature type used as an rf or if amplifier especially in high-frequency wide-band applications. It is useful as an amplifier at frequencies up to 400 megacycles per second. Outline 9,

# 6AK5

OUTLINES SECTION. Tube requires miniature seven-contact socket and may be mounted in any position. For heater and cathode considerations, refer to type 6AV6.

|  |                 |               |
|--|-----------------|---------------|
| HEATER VOLTAGE (AC/DC).....  | 6.3             | volts         |
| HEATER CURRENT.....  | 0.175           | ampere        |
| <b>DIRECT INTERELECTRODE CAPACITANCES (Approx. With external shield):</b>  |                 |               |
| Grid No.1 to Plate.....  | 0.02 <i>max</i> | $\mu\text{f}$ |
| Grid No.1 to Cathode, Heater, Grid No.2, Grid No.3, and Internal Shield... | 4.0             | $\mu\text{f}$ |
| Plate to Cathode, Heater, Grid No.2, Grid No.3, and Internal Shield.....   | 2.8             | $\mu\text{f}$ |

## Maximum Ratings:

|  |                   |       |
|--|-------------------|-------|
| PLATE VOLTAGE.....                                   | 180 max           | volts |
| GRID-NO.2 (SCREEN) VOLTAGE.....                      | See curve page 64 |       |
| GRID-NO.2 SUPPLY VOLTAGE.....                        | 180 max           | volts |
| PLATE DISSIPATION.....                               | 1.7 max           | watts |
| GRID-NO.2 INPUT:                                     |                   |       |
| For grid-No.2 voltages up to 90 volts.....           | 0.5 max           | watt  |
| For grid-No.2 voltages between 90 and 180 volts..... | See curve page 64 |       |
| CATHODE CURRENT.....                                 | 18 max            | ma    |
| PEAK HEATER-CATHODE VOLTAGE:                         |                   |       |
| Heater negative with respect to cathode.....         | 90 max            | volts |
| Heater positive with respect to cathode.....         | 90 max            | volts |

## Typical Operation and Characteristics:

|  |      |      |        |
|--|------|------|--------|
| Plate Voltage.....                             | 120  | 180  | volts  |
| Grid-No.2 Voltage.....                         | 120  | 120  | volts  |
| Cathode-Bias Resistor*.....                    | 180  | 180  | ohms   |
| Plate Resistance (Approx.).....                | 0.3  | 0.5  | megohm |
| Transconductance.....                          | 5000 | 5100 | μmhos  |
| Grid-No.1 Bias for plate current of 10 μa..... | -8.5 | -8.5 | volts  |
| Plate Current.....                             | 7.5  | 7.7  | ma     |
| Grid-No.2 Current.....                         | 2.5  | 2.4  | ma     |

\* Fixed-bias operation is not recommended.

AVERAGE PLATE CHARACTERISTICS  
PENTODE CONNECTION

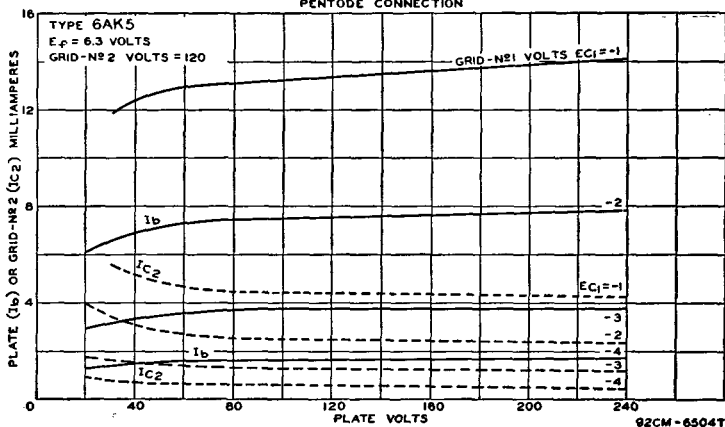

## 6AK6

### POWER PENTODE

Miniature type used in compact equipment as a power amplifier. Outline 13, OUTLINES SECTION. Tube requires miniature seven-contact socket and may be mounted in any position. For heater and cathode considerations, refer to type 6AV6.

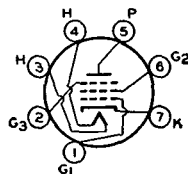

|   |      |        |
|---|------|--------|
| HEATER VOLTAGE (AC/DC).....                                 | 6.3  | volts  |
| HEATER CURRENT.....   | 0.15 | ampere |
| DIRECT INTERELECTRODE CAPACITANCES (Approx.):               |      |        |
| Grid No. 1 to Plate.....                                    | 0.12 | μμf    |
| Grid No.1 to Cathode, Heater, Grid No.2, and Grid No.3..... | 3.6  | μμf    |
| Plate to Cathode, Heater, Grid No.2, and Grid No.3.....     | 4.2  | μμf    |

### CLASS A<sub>1</sub> AMPLIFIER

#### Maximum Ratings:

|  |         |          |       |
|--|---------|----------|-------|
| PLATE VOLTAGE.....                           | 300 max | 300 max  | volts |
| GRID NO. 2 (SCREEN) VOLTAGE.....             | -       | 300 max  | volts |
| PLATE DISSIPATION.....                       | 3.5 max | 2.75 max | watts |
| GRID-NO.2 INPUT.....                         | -       | 0.75 max | watt  |
| PEAK HEATER-CATHODE VOLTAGE:                 |         |          |       |
| Heater negative with respect to cathode..... | 90 max  | 90 max   | volts |
| Heater positive with respect to cathode..... | 90 max  | 90 max   | volts |



### Typical Operation:

|                                | Triode#<br>Connection | Pentode<br>Connection          |           |
|--------------------------------|-----------------------|--------------------------------|-----------|
| Plate Voltage                  | 180                   | 180                            | volts     |
| Grid No. 3 (Suppressor)        | -                     | Connected to cathode at socket |           |
| Grid-No. 2 Voltage             | -                     | 180                            | volts     |
| Grid-No. 1 Voltage             | -12                   | -9                             | volts     |
| Peak AF Grid-No. 1 Voltage     | 12                    | 9                              | volts     |
| Zero-Signal Plate Current      | 12                    | 15                             | ma        |
| Zero-Signal Grid-No. 2 Current | -                     | 2.5                            | ma        |
| Plate Resistance               | 0.0044                | 0.2                            | megohm    |
| Amplification Factor           | 9.3                   | -                              |           |
| Transconductance               | 2100                  | 2300                           | $\mu$ hos |
| Load Resistance                | 12000                 | 10000                          | ohms      |
| Total Harmonic Distortion      | 5                     | 10                             | per cent  |
| Maximum-Signal Power Output    | 0.26                  | 1.1                            | watts     |

### Maximum Circuit Values:

|                               |         |        |
|-------------------------------|---------|--------|
| Grid-No.1-Circuit Resistance: |         |        |
| For fixed-bias operation      | 0.1 max | megohm |
| For cathode-bias operation    | 0.5 max | megohm |

# Grid No. 2 and grid No. 3 tied to plate.

AVERAGE PLATE CHARACTERISTICS  
PENTODE CONNECTION

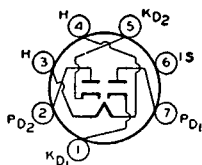
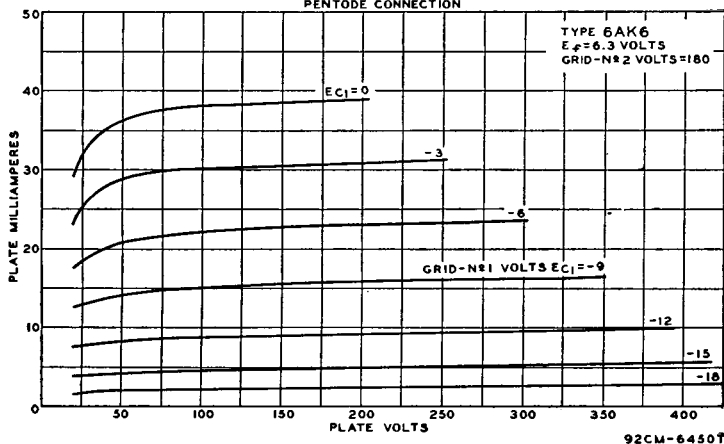

## TWIN DIODE

Miniature, high-perveance type used as detector in FM and television circuits. It is especially useful as a ratio detector in ac-operated FM receivers. Each diode section can be used

# 6AL5

independently of the other, or the two sections can be combined in parallel or full-wave arrangement. Resonant frequency of each unit is approximately 700 megacycles per second. Outline 9, OUTLINES SECTION. Tube requires miniature seven-contact socket and may be mounted in any position. For heater and cathode considerations, refer to type 6AV6.

|   |           |         |
|---|-----------|---------|
| HEATER VOLTAGE (AC/DC)                                    | 6.3       | volts   |
| HEATER CURRENT  | 0.3       | ampere  |
| DIRECT INTERELECTRODE CAPACITANCES:                       |           |         |
| Plate No. 1 to Cathode No. 1, Heater, and Internal Shield | 2.5       | $\mu$ f |
| Plate No. 2 to Cathode No. 2, Heater, and Internal Shield | 2.5       | $\mu$ f |
| Cathode No. 1 to Plate No. 1, Heater, and Internal Shield | 3.4       | $\mu$ f |
| Cathode No. 2 to Plate No. 2, Heater, and Internal Shield | 3.4       | $\mu$ f |
| Plate No. 1 to Plate No. 2                                | 0.068 max | $\mu$ f |

**Maximum Ratings:**
**HALF-WAVE RECTIFIER**

|  |         |       |
|--|---------|-------|
| PEAK INVERSE PLATE VOLTAGE.....              | 330 max | volts |
| PEAK PLATE CURRENT PER PLATE.....            | 54 max  | ma    |
| DC OUTPUT CURRENT PER PLATE.....             | 9 max   | ma    |
| <b>PEAK HEATER-CATHODE VOLTAGE:</b>          |         |       |
| Heater negative with respect to cathode..... | 330 max | volts |
| Heater positive with respect to cathode..... | 330 max | volts |

**Typical Operation:**

|  |     |       |
|--|-----|-------|
| AC Plate Voltage per Plate (rms).....            | 117 | volts |
| Min. Total Effective Plate-Supply Impedance..... | 300 | ohms  |
| DC Output Current per Plate.....                 | 9   | ma    |

**AVERAGE CHARACTERISTICS  
HALF-WAVE RECTIFICATION-SINGLE DIODE**

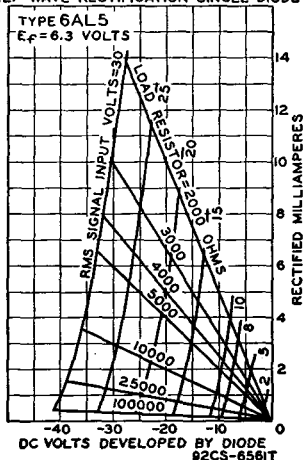
**ELECTRON-RAY TUBE**

## 6AL7-GT

Glass octal type used to indicate visually on a pair of rectangular fluorescent patterns the effects of changes in voltages applied to its grid and three deflecting electrodes. It is especially

useful in meeting the requirements for accurate tuning in FM receivers. Outline 18, OUTLINES SECTION. Tube requires octal socket and may be mounted in any position.

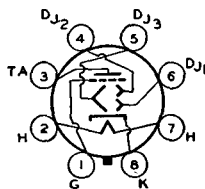

|                             |      |        |
|-----------------------------|------|--------|
| HEATER VOLTAGE (AC/DC)..... | 6.3  | volts  |
| HEATER CURRENT.....         | 0.15 | ampere |

**Maximum Ratings:**
**INDICATOR SERVICE**

|  |           |       |
|--|-----------|-------|
| TARGET VOLTAGE.....                          | { 365 max | volts |
|  | { 220 min | volts |
| <b>PEAK HEATER-CATHODE VOLTAGE:</b>          |           |       |
| Heater negative with respect to cathode..... | 90 max    | volts |
| Heater positive with respect to cathode..... | 90 max    | volts |

**Typical Operation:**

|  |      |         |
|--|------|---------|
| Target Voltage.....                                  | 315  | volts   |
| Deflecting-Electrode-No.1 Voltage.....               | 0    | volts   |
| Deflecting-Electrode-No.2 Voltage.....               | 0    | volts   |
| Deflecting-Electrode-No.3 Voltage.....               | 0    | volts   |
| Cathode Resistor (Approx.).....                      | 3300 | ohms    |
| Deflection Sensitivity (Approx.)#.....               | 1    | mm/volt |
| Grid Voltage for Fluorescence Cutoff (Approx.)*..... | -6   | volts   |

#For first millimeter of unbalance in FM application.

\*The grid should be connected to the cathode when not used for fluorescence control.

**MEDIUM-MU TRIODE—  
SHARP-CUTOFF PENTODE**

**6AN8**

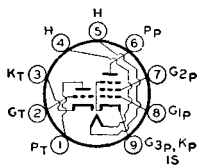

Miniature type used in a wide variety of applications in color television receivers. The pentode unit is used as an intermediate-frequency amplifier, a video amplifier, an age amplifier,

or as a reactance tube. The triode unit is used in low-frequency oscillator, sync-separator, sync-clipper, and phase-splitter circuits. Outline 14, OUTLINES SECTION. Tube requires miniature nine-contact socket and may be mounted in any position.

|  |          |               |
|--|----------|---------------|
| HEATER VOLTAGE (AC/DC).....  | 6.3      | volts         |
| HEATER CURRENT.....  | 0.45     | ampere        |
| DIRECT INTERELECTRODE CAPACITANCES:  |          |               |
| Triode Unit:   |          |               |
| Grid to Plate.....   | 1.5      | $\mu\text{f}$ |
| Grid to Cathode and Heater.....  | 2.0      | $\mu\text{f}$ |
| Plate to Cathode and Heater.....   | 0.27     | $\mu\text{f}$ |
| Pentode Unit:  |          |               |
| Grid No.1 to Plate.....  | 0.04 max | $\mu\text{f}$ |
| Grid No.1 to Cathode, Heater, Grid No.2, Grid No.3, and Internal Shield... | 7        | $\mu\text{f}$ |
| Plate to Cathode, Heater, Grid No.2, Grid No.3, and Internal Shield.....   | 2.3      | $\mu\text{f}$ |
| Triode Grid to Pentode Plate.....  | 0.005    | $\mu\text{f}$ |
| Pentode Grid No.1 to Triode Plate.....                                     | 0.006    | $\mu\text{f}$ |
| Pentode Plate to Triode Plate.....   | 0.045    | $\mu\text{f}$ |

**AMPLIFIER—CLASS A<sub>1</sub>**

|   |                    |                     |       |
|---|--------------------|---------------------|-------|
| <b>Maximum Ratings:</b>                               | <i>Triode Unit</i> | <i>Pentode Unit</i> |       |
| PLATE VOLTAGE.....                                    | 300 max            | 300 max             | volts |
| GRID-NO.2 SUPPLY VOLTAGE.....                         | —                  | 300 max             | volts |
| GRID-NO.2 (SCREEN) VOLTAGE.....                       | —                  | See curve page 64   | volts |
| GRID-NO.1 (CONTROL-GRID) VOLTAGE.....                 | 0 max              | max                 | volts |
| PLATE DISSIPATION.....                                | 2.5 max            | max                 | watts |
| GRID-NO.2 INPUT:                                      |                    |                     |       |
| For grid-No.2 voltages up to 150 volts.....           | —                  | 0.5 max             | watt  |
| For grid-No.2 voltages between 150 and 300 volts..... | —                  | See curve page 64   | volts |
| <b>PEAK HEATER-CATHODE VOLTAGE:</b>                   |                    |                     |       |
| Heater negative with respect to cathode.....          | 200 max            | 200 max             | volts |
| Heater positive with respect to cathode.....          | 200 <sup>max</sup> | 200 max             | volts |

**Typical Operation:**

|                               |     |     |       |
|-------------------------------|-----|-----|-------|
| Plate Supply Voltage.....     | 200 | 200 | volts |
| Grid-No.2 Supply Voltage..... | —   | 150 | volts |
| Grid-No.1 Voltage.....        | -6  | —   | volts |
| Cathode-Bias Resistor.....    | —   | 180 | ohms  |

AVERAGE PLATE CHARACTERISTICS  
PENTODE UNIT

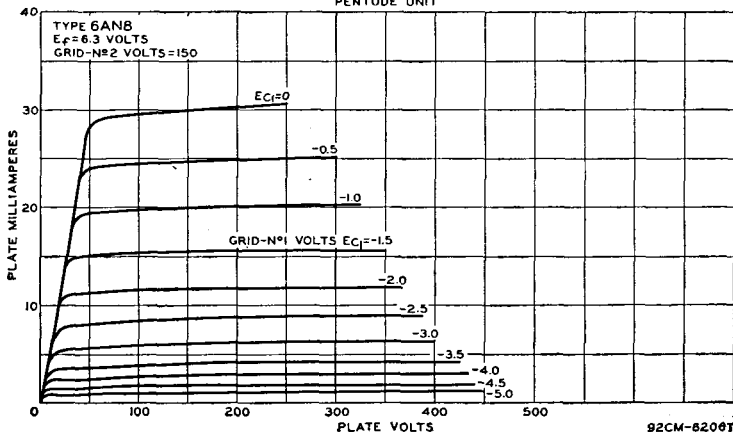

|   |      |        |            |
|---|------|--------|------------|
| Amplification Factor.....                                     | 19   | —      |            |
| Plate Resistance (Approx.).....                               | 5750 | 300000 | ohms       |
| Transconductance.....   | 3300 | 6200   | $\mu$ mhos |
| Grid-No.1 Bias (Approx.) for Plate Current of 10 $\mu$ a..... | -19  | -8     | volts      |
| Plate Current.....  | 13   | 9.5    | ma         |
| Grid-No.2 Current.....  | —    | 2.8    | ma         |

**Maximum Circuit Values:**

|                                       |         |          |        |
|---------------------------------------|---------|----------|--------|
| <b>Grid-No.1-Circuit Resistance:*</b> |         |          |        |
| For fixed-bias operation.....         | 0.5 max | 0.25 max | megohm |
| For cathode-bias operation.....       | 1.0 max | 1.0 max  | megohm |

\*The dc component must not exceed 100 volts.

\*If either unit is operating at maximum rated conditions, grid-No.1-circuit resistance for both units should not exceed the stated values.

**AVERAGE PLATE CHARACTERISTICS**  
TRIODE UNIT

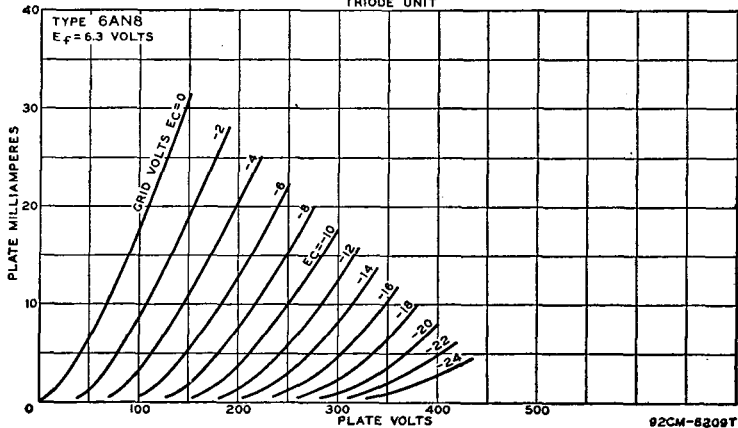

## BEAM POWER TUBE

# 6AQ5

Miniature type used as output amplifier primarily in automobile receivers and in ac-operated receivers. Within its maximum ratings, the performance of the 6AQ5 is equivalent to that of larger types 6V6 and 6V6-GT.

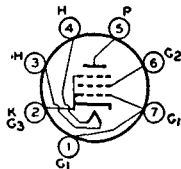

For typical circuits employing type 6AQ5, both singly and in push-pull, refer to **CIRCUIT SECTION**.

|   |      |         |
|---|------|---------|
| HEATER VOLTAGE (AC/DC).....                                 | 6.3  | volts   |
| HEATER CURRENT.....   | 0.45 | ampere  |
| <b>DIRECT INTERELECTRODE CAPACITANCES (Approx.):</b>        |      |         |
| Grid No. 1 to Plate.....                                    | 0.35 | $\mu$ f |
| Grid No.1 to Cathode, Heater, Grid No.2, and Grid No.3..... | 8.3  | $\mu$ f |
| Plate to Cathode, Heater, Grid No.2, and Grid No.3.....     | 8.2  | $\mu$ f |

### CLASS A<sub>1</sub> AND CLASS AB<sub>1</sub> PUSH-PULL AMPLIFIER

**Maximum Ratings:**

|  |         |       |
|--|---------|-------|
| PLATE VOLTAGE.....                           | 250 max | volts |
| GRID-NO. 2 VOLTAGE.....                      | 250 max | volts |
| PLATE DISSIPATION.....                       | 12 max  | watts |
| GRID-NO.2 INPUT.....                         | 2 max   | watts |
| <b>PEAK HEATER-CATHODE VOLTAGE:</b>          |         |       |
| Heater negative with respect to cathode..... | 90 max  | volts |
| Heater positive with respect to cathode..... | 90 max  | volts |

## Typical Operation:

Same as for type 6V6-GT within the limitations of the maximum ratings.

## Maximum Circuit Values:

### Grid-No.1-Circuit Resistance:

|                                  |         |        |
|----------------------------------|---------|--------|
| For fixed-bias operation .....   | 0.1 max | megohm |
| For cathode-bias operation ..... | 0.5 max | megohm |

## INSTALLATION AND APPLICATION

Type 6AQ5 requires a miniature seven-contact socket and may be mounted in any position. Outline 16, OUTLINES SECTION.

When the heater is operated on ac with a transformer, the winding of the transformer which supplies the heater circuit should operate the heater at the recommended value for full-load operating conditions at average line voltage. Under any condition of operation, the heater voltage should not be allowed to vary more than 10% from the rated value. When the 6AQ5 is used in automobile receivers, the heater terminals should be connected directly across the 6-volt battery.

Use of type 6AQ5 in a series string arrangement should be limited to tubes with the same heater-current rating. If it is necessary to use the 6AQ5 in series with tubes having different heater ratings, shunt resistors are required. Refer to ELECTRON TUBE INSTALLATION SECTION for additional heater considerations.

The cathode of the 6AQ5 should preferably be connected directly to the electrical mid-point of the heater circuit when the heater voltage is supplied from a transformer. When the 6AQ5 is operated in receivers employing a 6-volt storage battery for the heater supply, its cathode circuit is tied in either directly or through bias resistors to the negative side of the dc plate supply which is furnished either by the dc power line or the ac line through a rectifier. Under any circumstances, the heater-cathode voltage should be kept within ratings. If the use of a large resistor is necessary in some circuit designs, it should be bypassed by a suitable filter network or objectionable hum may develop.

In all services, precautions should be taken to insure that the dissipation rating is not exceeded with expected line-voltage variations, especially in the cases of fixed-bias operation. When the push-pull connection is used, fixed-bias values up to 10% of each typical screen voltage can be used without increasing distortion.

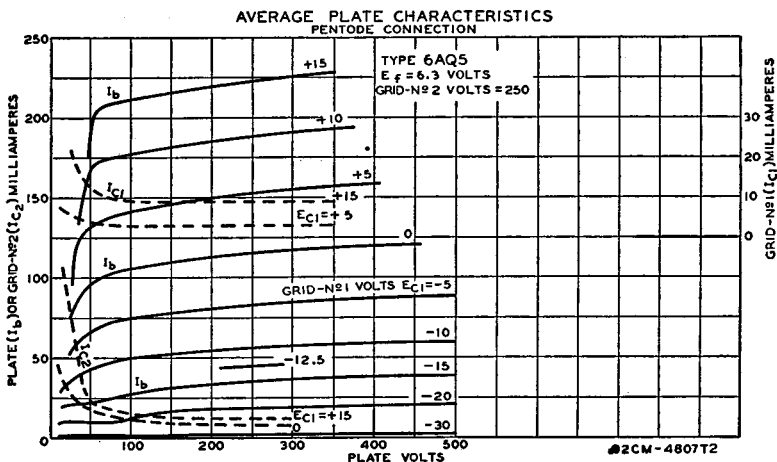

# 6AQ6

## TWIN DIODE—HIGH-MU TRIODE

Miniature type used as a combined detector, amplifier, and avc tube in compact radio receivers. This type is similar to metal type 6Q7 in many of its electrical characteristics. Outline 13,

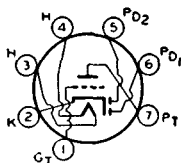

**OUTLINES SECTION.** Tube requires miniature seven-contact socket and may be mounted in any position. For typical operation as resistance-coupled amplifier, refer to Chart 7, **RESISTANCE-COUPLED AMPLIFIER SECTION.** For heater considerations, refer to type 6AV6.

|   |      |                  |
|---|------|------------------|
| HEATER VOLTAGE (AC/DC) .....                              | 6.3  | volts            |
| HEATER CURRENT .....                                      | 0.15 | ampere           |
| <b>DIRECT INTERELECTRODE CAPACITANCES (Triode Unit):°</b> |      |                  |
| Grid to Plate .....                                       | 1.8  | $\mu\mu\text{f}$ |
| Grid to Cathode and Heater .....                          | 1.7  | $\mu\mu\text{f}$ |
| Plate to Cathode and Heater .....                         | 1.5  | $\mu\mu\text{f}$ |

° With close-fitting shield connected to cathode.

### TRIODE UNIT AS CLASS A<sub>1</sub> AMPLIFIER

**Maximum Ratings:**

|   |                |       |
|---|----------------|-------|
| PLATE VOLTAGE .....                           | 300 <i>maz</i> | volts |
| <b>PEAK HEATER-CATHODE VOLTAGE:</b>           |                |       |
| Heater negative with respect to cathode ..... | 90 <i>maz</i>  | volts |
| Heater positive with respect to cathode ..... | 90 <i>maz</i>  | volts |

**Characteristics:**

|                            |       |       |                  |
|----------------------------|-------|-------|------------------|
| Plate Voltage .....        | 100   | 250   | volts            |
| Grid Voltage .....         | -1    | -3    | volts            |
| Amplification Factor ..... | 70    | 70    |                  |
| Plate Resistance .....     | 61000 | 58000 | ohms             |
| Transconductance .....     | 1150  | 1200  | $\mu\text{mhos}$ |
| Plate Current .....        | 0.8   | 1.0   | ma               |

### DIODE UNITS

Two diode plates are placed around a cathode, the sleeve of which is common to the triode unit. Diode biasing of the triode unit of the 6AQ6 is not suitable. For diode operation curves, refer to type 6AV6.

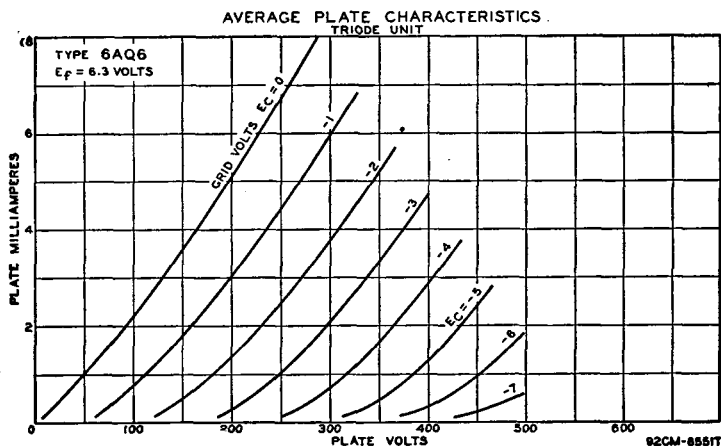

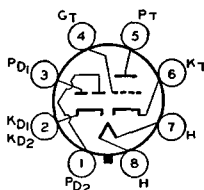

**TWIN DIODE—HIGH-MU TRIODE**

Glass octal type used as FM detector and audio amplifier in circuits which require diode and triode units with separate cathodes. Outline 23, OUTLINES SECTION. Tube requires octal socket. Heater volts (ac/dc), 6.3; amperes, 0.3. Ratings and characteristics of triode unit as class A<sub>1</sub> amplifier: plate volts, 250 *max*; grid volts, -2; amplification factor, 70; plate resistance (approx.), 44000 ohms; transconductance,

**6AQ7-GT**

1600  $\mu$ mhos; plate ma., 2.3. For typical operation as a resistance-coupled amplifier, refer to Chart 7, RESISTANCE-COUPLED AMPLIFIER SECTION. This type is used principally for renewal purposes.

**POWER PENTODE**

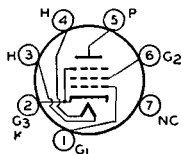

Miniature type used as output tube primarily in automobile receivers and ac-operated receivers. Outline 16, OUTLINES SECTION. Tube requires miniature seven-contact socket and may be mounted in any position. For heater and cathode considerations, refer to miniature type 6AQ5. Within its maximum ratings, type 6AR5 is equivalent in performance to glass-octal type 6K6-GT. Refer to type 6K6-GT for characteristic curves. Type 6AR5 is used principally for renewal purposes.

**6AR5**

|                             |     |        |
|-----------------------------|-----|--------|
| HEATER VOLTAGE (AC/DC)..... | 6.3 | volts  |
| HEATER CURRENT.....         | 0.4 | ampere |

**Maximum Ratings:**

**CLASS A<sub>1</sub> AMPLIFIER**

|  |                |       |
|--|----------------|-------|
| PLATE VOLTAGE.....                           | 250 <i>max</i> | volts |
| GRID-NO.2 (SCREEN) VOLTAGE.....              | 250 <i>max</i> | volts |
| PLATE DISSIPATION.....                       | 8.5 <i>max</i> | watts |
| GRID-NO.2 INPUT.....                         | 2.5 <i>max</i> | watts |
| PEAK HEATER-CATHODE VOLTAGE:                 |                |       |
| Heater negative with respect to cathode..... | 90 <i>max</i>  | volts |
| Heater positive with respect to cathode..... | 90 <i>max</i>  | volts |

**Typical Operation and Characteristics:**

|                                       |       |       |            |
|---------------------------------------|-------|-------|------------|
| Plate Voltage.....                    | 250   | 250   | volts      |
| Grid-No.2 Voltage.....                | 250   | 250   | volts      |
| Grid-No.1 (Control-Grid) Voltage..... | -16.5 | -18   | volts      |
| Peak AF Grid-No.1 Voltage.....        | 16.5  | 18    | volts      |
| Zero-Signal Plate Current.....        | 34    | 32    | ma         |
| Maximum-Signal Plate Current.....     | 35    | 33    | ma         |
| Zero-Signal Grid-No.2 Current.....    | 5.7   | 5.5   | ma         |
| Maximum-Signal Grid-No.2 Current..... | 10    | 10    | ma         |
| Plate Resistance (Approx.).....       | 65000 | 68000 | ohms       |
| Transconductance.....                 | 2400  | 2300  | $\mu$ mhos |
| Load Resistance.....                  | 7000  | 7600  | ohms       |
| Total Harmonic Distortion.....        | 7     | 11    | per cent   |
| Maximum-Signal Power Output.....      | 3.2   | 3.4   | watts      |

**Maximum Circuit Values (For maximum rated conditions):**

|                                 |                |        |
|---------------------------------|----------------|--------|
| Grid-No.1-Circuit Resistance:   |                |        |
| For fixed-bias operation.....   | 0.1 <i>max</i> | megohm |
| For cathode-bias operation..... | 0.5 <i>max</i> | megohm |

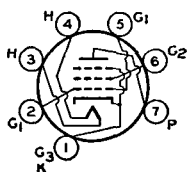

**BEAM POWER TUBE**

Miniature type used as output amplifier primarily in automobile and in ac-operated receivers. Outline 16, OUTLINES SECTION. Tube requires miniature seven-contact socket and may be mounted in any position.

**6AS5**

For heater and cathode considerations, refer to type 6AQ5. For curves, refer to type 35C5.

|  |     |               |
|--|-----|---------------|
| HEATER VOLTAGE (AC/DC) .....                                 | 6.3 | volts         |
| HEATER CURRENT .....   | 0.8 | ampere        |
| DIRECT INTERELECTRODE CAPACITANCES (Approx.):                |     |               |
| Grid No.1 to Plate .....                                     | 0.6 | $\mu\text{f}$ |
| Grid No.1 to Cathode, Heater, Grid No.2, and Grid No.3 ..... | 12  | $\mu\text{f}$ |
| Plate to Cathode, Heater, Grid No.2, and Grid No.3 .....     | 9.0 | $\mu\text{f}$ |

**Maximum Ratings:**

**CLASS A<sub>1</sub> AMPLIFIER**

|   |                |                    |
|---|----------------|--------------------|
| PLATE VOLTAGE .....                                       | 150 <i>max</i> | volts              |
| GRID-NO.2 (SCREEN) VOLTAGE .....                          | 117 <i>max</i> | volts              |
| PLATE DISSIPATION .....                                   | 5.5 <i>max</i> | watts              |
| GRID-NO.2 INPUT .....                                     | 1.0 <i>max</i> | watt               |
| PEAK HEATER-CATHODE VOLTAGE:                              |                |                    |
| Heater negative with respect to cathode .....             | 90 <i>max</i>  | volts              |
| Heater positive with respect to cathode .....             | 90 <i>max</i>  | volts              |
| BULB TEMPERATURE (At hottest point on bulb surface) ..... | 250 <i>max</i> | $^{\circ}\text{C}$ |

**Typical Operation:**

|  |      |                  |
|--|------|------------------|
| Plate Voltage .....                              | 150  | volts            |
| Grid-No.2 Voltage .....                          | 110  | volts            |
| Grid-No.1 (Control-Grid) Voltage .....           | -8.5 | volts            |
| Peak AF Grid-No.1 Voltage .....                  | 8.5  | volts            |
| Zero-Signal Plate Current .....                  | 35   | ma               |
| Maximum-Signal Plate Current .....               | 36   | ma               |
| Zero-Signal Grid-No.2 Current (Approx.) .....    | 2    | ma               |
| Maximum-Signal Grid-No.2 Current (Approx.) ..... | 6.5  | ma               |
| Transconductance .....                           | 5600 | $\mu\text{mhos}$ |
| Load Resistance .....                            | 4500 | ohms             |
| Total Harmonic Distortion .....                  | 10   | per cent         |
| Maximum-Signal Power Output .....                | 2.2  | watts            |

**Maximum Circuit Values (For maximum rated conditions):**

|                                  |                |        |
|----------------------------------|----------------|--------|
| Grid-No.1-Circuit Resistance:    |                |        |
| For fixed-bias operation .....   | 0.1 <i>max</i> | megohm |
| For cathode-bias operation ..... | 0.5 <i>max</i> | megohm |

## DIODE— SHARP-CUTOFF PENTODE

# 6AS8

Miniature type used in diversified applications in television and radio receivers. The pentode unit is used as an if amplifier, video amplifier, or agc amplifier. The high-perveance diode is

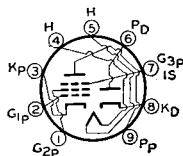

used as an audio detector, video detector, or dc restorer. Outline 14, **OUTLINES SECTION**. Tube requires miniature nine-contact socket and may be mounted in any position. For curve of average plate characteristics of pentode unit, see type 6AN8.

|   |                  |               |
|---|------------------|---------------|
| HEATER VOLTAGE (AC/DC) .....  | 6.3              | volts         |
| HEATER CURRENT .....  | 0.45             | ampere        |
| DIRECT INTERELECTRODE CAPACITANCES (Approx.):                                 |                  |               |
| Diode Unit:   |                  |               |
| Plate to Cathode, Heater, and Internal Shield .....                           | 3.0              | $\mu\text{f}$ |
| Pentode Unit:   |                  |               |
| Grid No.1 to Plate .....  | 0.04 <i>max</i>  | $\mu\text{f}$ |
| Grid No.1 to Cathode, Heater, Grid No.2, Grid No.3, and Internal Shield ..... | 7                | $\mu\text{f}$ |
| Plate to Cathode, Heater, Grid No.2, Grid No.3, and Internal Shield .....     | 2.2              | $\mu\text{f}$ |
| Pentode Grid to Diode Plate .....   | 0.005 <i>max</i> | $\mu\text{f}$ |
| Pentode Plate to Diode Cathode .....  | 0.15 <i>max</i>  | $\mu\text{f}$ |
| Pentode Plate to Diode Plate .....  | 0.10 <i>max</i>  | $\mu\text{f}$ |

**Maximum Ratings:**

**PENTODE UNIT AS CLASS A<sub>1</sub> AMPLIFIER**

|  |                   |       |
|--|-------------------|-------|
| PLATE VOLTAGE .....                                    | 300 <i>max</i>    | volts |
| GRID-NO.3 (SUPPRESSOR) VOLTAGE .....                   | 0 <i>max</i>      | volts |
| GRID-NO.2 SUPPLY VOLTAGE .....                         | 300 <i>max</i>    | volts |
| GRID-NO.2 (SCREEN) VOLTAGE .....                       | See curve page 64 |       |
| GRID-NO.1 (CONTROL-GRID) VOLTAGE:                      |                   |       |
| Positive bias value .....                              | 0 <i>max</i>      | volts |
| PLATE DISSIPATION .....                                | 2.5 <i>max</i>    | watts |
| GRID-NO.2 INPUT:                                       |                   |       |
| For grid-No.2 voltages up to 150 volts .....           | 0.5 <i>max</i>    | watt  |
| For grid-No.2 voltages between 150 and 300 volts ..... | See curve page 64 |       |



|  |                 |       |
|--|-----------------|-------|
| <b>PEAK HEATER-CATHODE VOLTAGE:</b>          |                 |       |
| Heater negative with respect to cathode..... | 200 <i>max</i>  | volts |
| Heater positive with respect to cathode..... | 200° <i>max</i> | volts |

**Characteristics:**

|   |                                |            |
|---|--------------------------------|------------|
| Plate Supply Voltage.....                                     | 200                            | volts      |
| Grid No.3.....  | Connected to cathode at socket |            |
| Grid-No.2 Supply Voltage.....                                 | 150                            | volts      |
| Cathode-Bias Resistor.....                                    | 180                            | ohms       |
| Plate Resistance (Approx.).....                               | 300000                         | ohms       |
| Transconductance.....   | 6200                           | $\mu$ mhos |
| Grid-No.1 Bias (Approx.) for plate current of 10 $\mu$ a..... | -8                             | volts      |
| Plate Current.....  | 9.5                            | ma         |
| Grid-No.2 Current.....  | 3                              | ma         |

**Maximum Circuit Values (For maximum rated conditions):**

|                                      |                 |        |
|--------------------------------------|-----------------|--------|
| <b>Grid-No.1-Circuit Resistance:</b> |                 |        |
| For fixed-bias operation.....        | 0.25 <i>max</i> | megohm |
| For cathode-bias operation.....      | 1.0 <i>max</i>  | megohm |

° The dc component must not exceed 100 volts.

**Maximum Ratings:**

**DIODE UNIT**

|  |                 |       |
|--|-----------------|-------|
| PEAK INVERSE PLATE VOLTAGE.....              | 330 <i>max</i>  | volts |
| PEAK PLATE CURRENT.....                      | 50 <i>max</i>   | ma    |
| DC PLATE CURRENT.....                        | 5 <i>max</i>    | ma    |
| <b>PEAK HEATER-CATHODE VOLTAGE:</b>          |                 |       |
| Heater negative with respect to cathode..... | 200 <i>max</i>  | volts |
| Heater positive with respect to cathode..... | 200° <i>max</i> | volts |

° The dc component must not exceed 100 volts.

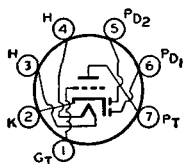

## TWIN DIODE—HIGH-MU TRIODE

Miniature type used as a combined detector, amplifier, and avc tube in automobile and ac-operated radio receivers. Outline 13, OUTLINES SECTION. Tube requires miniature

# 6AT6

seven-contact socket and may be mounted in any position. For typical operation as resistance-coupled amplifier, refer to Chart 7, RESISTANCE-COUPLED AMPLIFIER SECTION. For heater considerations, refer to type 6AV6.

|  |                 |         |
|--|-----------------|---------|
| HEATER VOLTAGE (AC/DC).....                  | 6.3             | volts   |
| HEATER CURRENT.....                          | 0.3             | ampere  |
| <b>DIRECT INTERELECTRODE CAPACITANCES:</b>   |                 |         |
| Triode Grid to Triode Plate.....             | 2.0             | $\mu$ f |
| Triode Grid to Cathode and Heater.....       | 2.2             | $\mu$ f |
| Triode Plate to Cathode and Heater.....      | 0.8             | $\mu$ f |
| Plate of Diode Unit No.2 to Triode Grid..... | 0.04 <i>max</i> | $\mu$ f |

**Maximum Ratings:**

**TRIODE UNIT AS CLASS A<sub>1</sub> AMPLIFIER**

|  |                |       |
|--|----------------|-------|
| PLATE VOLTAGE.....                           | 300 <i>max</i> | volts |
| PLATE DISSIPATION.....                       | 0.5 <i>max</i> | watt  |
| GRID VOLTAGE, Positive Bias Value.....       | 0 <i>max</i>   | volts |
| <b>PEAK HEATER-CATHODE VOLTAGE:</b>          |                |       |
| Heater negative with respect to cathode..... | 90 <i>max</i>  | volts |
| Heater positive with respect to cathode..... | 90 <i>max</i>  | volts |

**Characteristics:**

|                           |       |       |            |
|---------------------------|-------|-------|------------|
| Plate Voltage.....        | 100   | 250   | volts      |
| Grid Voltage.....         | -1    | -3    | volts      |
| Amplification Factor..... | 70    | 70    |            |
| Plate Resistance.....     | 54000 | 58000 | ohms       |
| Transconductance.....     | 1300  | 1200  | $\mu$ mhos |
| Plate Current.....        | 0.8   | 1.0   | ma         |

**DIODE UNITS**

|                                |                   |
|--------------------------------|-------------------|
| <b>Maximum Rating:</b>         |                   |
| PLATE CURRENT (EACH UNIT)..... | 1.0 <i>max</i> ma |

The two diode plates are placed around a cathode, the sleeve of which is common to the triode unit. Each diode plate has its own base pin. For diode operation curves, refer to type 6AV6.

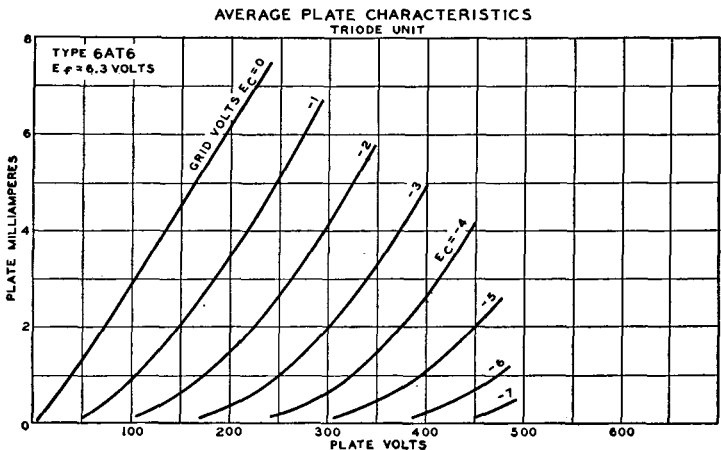

# 6AT8

## TRIODE-PENTODE CONVERTER

Miniature type used as combined oscillator and mixer tube in television receivers utilizing an intermediate frequency in the order of 40 megacycles per second. Outline 14, OUTLINES

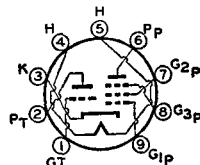

SECTION. Except for interelectrode capacitances and basing arrangement, this type is identical with miniature type 6X8. The basing arrangement of the 6AT8 is particularly suitable for connection to the coils of certain designs of turret tuners.

DIRECT INTERELECTRODE CAPACITANCES (Approx.):

|  | Without External Shield | With External Shield |               |
|--|-------------------------|----------------------|---------------|
| <b>Triode Unit:</b>                                    |                         |                      |               |
| Grid to Plate  | 1.6                     | 1.6                  | $\mu\text{f}$ |
| Grid to Cathode and Heater                             | 2.0                     | 2.4                  | $\mu\text{f}$ |
| Plate to Cathode and Heater                            | 0.45                    | 0.9                  | $\mu\text{f}$ |
| <b>Pentode Unit:</b>                                   |                         |                      |               |
| Grid No.1 to Plate                                     | 0.08 max                | 0.06 max             | $\mu\text{f}$ |
| Grid No.1 to Cathode, Heater, Grid No.2, and Grid No.3 | 4.3                     | 4.5                  | $\mu\text{f}$ |
| Plate to Cathode, Heater, Grid No.2, and Grid No.3     | 0.8                     | 1.5                  | $\mu\text{f}$ |
| Pentode Grid No.1 to Triode Plate                      | 0.05 max                | 0.04 max             | $\mu\text{f}$ |
| Pentode Plate to Triode Plate                          | 0.05 max                | 0.007 max            | $\mu\text{f}$ |
| Heater to Cathode                                      | 5.5                     | 5.5                  | $\mu\text{f}$ |
| <b>Pentode Unit Connected as Triode*:</b>              |                         |                      |               |
| Grid No.1 to Plate                                     | 1.3                     | 1.25                 | $\mu\text{f}$ |
| Grid No.1 to Cathode and Heater                        | 3.1                     | 3.4                  | $\mu\text{f}$ |
| Plate to Cathode and Heater                            | 1.5                     | 2.3                  | $\mu\text{f}$ |

\* Grid No.3 connected to cathode; grid No.2 connected to plate.

## HALF-WAVE VACUUM RECTIFIER

# 6AU4-GT

Glass octal type used as a damper tube in horizontal-deflection circuits of color television receivers and of television receivers utilizing picture tubes having wide-angle deflection. Outline

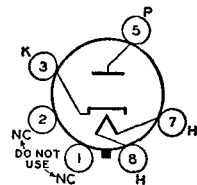

29, OUTLINES SECTION. Tube requires octal socket and may be mounted in any position. This type may be supplied with pin No.1 omitted. It is especially important that this tube, like other power-handling tubes, be adequately ventilated. For curve of average plate characteristics, see page 61.

|   |      |               |
|---|------|---------------|
| HEATER VOLTAGE (AC/DC).....                   | 6.3  | volts         |
| HEATER CURRENT.....                           | 1.8  | amperes       |
| DIRECT INTERELECTRODE CAPACITANCES (Approx.): |      |               |
| Plate to Heater and Cathode.....              | 8.5  | $\mu\text{f}$ |
| Cathode to Heater and Plate.....              | 11.5 | $\mu\text{f}$ |
| Heater to Cathode.....                        | 4.0  | $\mu\text{f}$ |

### DAMPER SERVICE

*For operation in a 525-line, 30-frame system*

#### Maximum Ratings:

|  |                        |       |
|--|------------------------|-------|
| PEAK INVERSE PLATE VOLTAGE ( <i>Absolute Maximum</i> ).....              | 4500 <sup>o</sup> max  | volts |
| PEAK PLATE CURRENT.....  | 1050 max               | ma    |
| DC PLATE CURRENT.....  | 175 max                | ma    |
| PEAK DISSIPATION.....  | 6.0 max                | watts |
| PEAK HEATER-CATHODE VOLTAGE:   |                        |       |
| Heater negative with respect to cathode ( <i>Absolute Maximum</i> )..... | 4500 <sup>o</sup> *max | volts |
| Heater positive with respect to cathode.....                             | 300 # max              | volts |

<sup>o</sup> Under no circumstances should this absolute value be exceeded.

\* The dc component must not exceed 900 volts.

# The dc component must not exceed 100 volts.

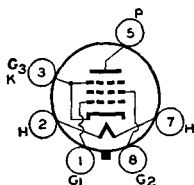

### BEAM POWER TUBE

Glass octal type used as horizontal deflection amplifier in low-cost, high-efficiency deflection circuits of television receivers employing either transformer coupling or direct coupling to

## 6AU5-GT

the deflecting yoke. Outline 22, OUTLINES SECTION. Tube requires octal socket and may be mounted in any position.

|   |      |                  |
|---|------|------------------|
| HEATER VOLTAGE (AC/DC).....                                 | 6.3  | volts            |
| HEATER CURRENT.....   | 1.25 | amperes          |
| DIRECT INTERELECTRODE CAPACITANCES (Approx.):               |      |                  |
| Grid No.1 to Plate.....                                     | 0.5  | $\mu\text{f}$    |
| Grid No.1 to Cathode, Heater, Grid No.2, and Grid No.3..... | 11.3 | $\mu\text{f}$    |
| Plate to Cathode, Heater, Grid No.2, and Grid No.3.....     | 7.0  | $\mu\text{f}$    |
| TRANSCONDUCTANCE #.....                                     | 5600 | $\mu\text{mhos}$ |
| MU-FACTOR, Grid No.2 to Grid No.1†.....                     | 5.9  |                  |

# For plate volts, 115; grid-No.2 volts, 175; grid-No.1 volts, -20.

† For plate volts, 100; grid-No.2 volts, 100; grid-No.1 volts, -4.5.

### HORIZONTAL DEFLECTION AMPLIFIER

*For operation in a 525-line, 30-frame system*

#### Maximum Ratings:

|   |                       |                    |
|---|-----------------------|--------------------|
| DC PLATE VOLTAGE.....   | 550 max               | volts              |
| PEAK POSITIVE-PULSE PLATE VOLTAGE* ( <i>Absolute Maximum</i> )..... | 5500 <sup>o</sup> max | volts              |
| PEAK NEGATIVE-PULSE PLATE VOLTAGE*.....                             | -1250 max             | volts              |
| DC GRID-NO.2 (SCREEN) VOLTAGE†.....                                 | 200 max               | volts              |
| PEAK NEGATIVE-PULSE GRID-NO.1 (CONTROL-GRID) VOLTAGE.....           | -300 max              | volts              |
| CATHODE CURRENT:  |                       |                    |
| Peak.....   | 400 max               | ma                 |
| DC.....   | 110 max               | ma                 |
| GRID-NO.2 INPUT.....  | 2.5 max               | watts              |
| PLATE DISSIPATION††.....  | 10 max                | watts              |
| PEAK HEATER-CATHODE VOLTAGE:  |                       |                    |
| Heater negative with respect to cathode.....                        | 200 max               | volts              |
| Heater positive with respect to cathode.....                        | 200 # max             | volts              |
| BULB TEMPERATURE (At hottest point).....                            | 210 max               | $^{\circ}\text{C}$ |

#### Maximum Circuit Value:

|                                   |          |        |
|-----------------------------------|----------|--------|
| Grid-No.1-Circuit Resistance..... | 0.47 max | megohm |
|-----------------------------------|----------|--------|

\* The duration of the voltage pulse must not exceed 15 per cent of one horizontal scanning cycle. In a 525-line, 30-frame system, 15 per cent of one horizontal scanning cycle is 10 microseconds.

<sup>o</sup> Under no circumstances should this absolute value be exceeded.

† Preferably obtained through a series dropping resistor of sufficient magnitude to limit the grid-No.2 input to the rated maximum value.

†† An adequate bias resistor or other means is required to protect the tube in the absence of excitation.

# The dc component must not exceed 100 volts.

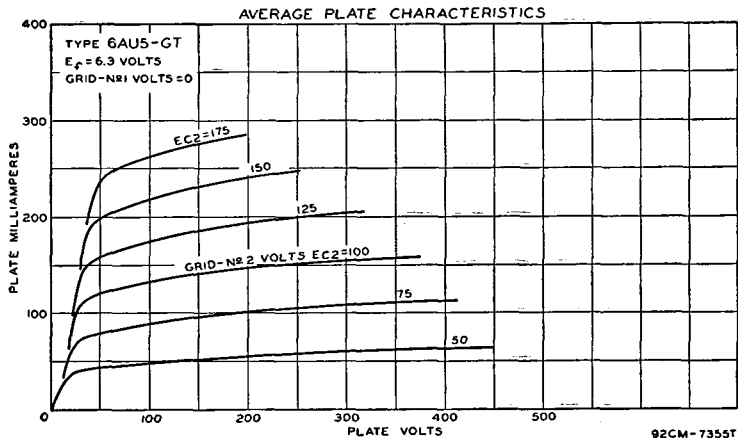

### SHARP-CUTOFF PENTODE

## 6AU6

Miniature type used in compact radio equipment as an rf amplifier especially in high-frequency, wide-band applications. It is also used as a limiter tube in FM equipment. Outline 13,

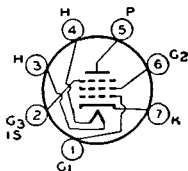

**OUTLINES SECTION.** Tube requires miniature seven-contact socket and may be mounted in any position. For a discussion of limiters, refer to **ELECTRON TUBE APPLICATIONS SECTION.** For typical operation as resistance-coupled amplifier, refer to Chart 8, **RESISTANCE-COUPLED AMPLIFIER SECTION.** For heater and cathode considerations, refer to type 6AV6.

|  |            |        |
|--|------------|--------|
| HEATER VOLTAGE (AC/DC).....  | 6.3        | volts  |
| HEATER CURRENT.....  | 0.3        | ampere |
| <b>DIRECT INTERELECTRODE CAPACITANCES (No external shield):</b>              |            |        |
| Grid No.1 to Plate.....  | 0.0035 max | μf     |
| Grid No.1 to Cathode, Heater, Grid No.2, Grid No.3, and Internal Shield..... | 5.5        | μf     |
| Plate to Cathode, Heater, Grid No.2, Grid No.3, and Internal Shield....      | 5.0        | μf     |

### CLASS A<sub>1</sub> AMPLIFIER

**Maximum Ratings:**

|   | <i>Triode†<br/>Connection</i> | <i>Pentode<br/>Connection</i> |       |
|---|-------------------------------|-------------------------------|-------|
| PLATE VOLTAGE.....                                    | 250 max                       | 300 max                       | volts |
| GRID-NO.2 (SCREEN) VOLTAGE.....                       | -                             | See curve page 64             |       |
| GRID-NO.2 SUPPLY VOLTAGE.....                         | -                             | 300 max                       | volts |
| PLATE DISSIPATION.....                                | 3.2 max                       | 3 max                         | watts |
| GRID-NO.2 INPUT:                                      |                               |                               |       |
| For grid-No.2 voltages up to 150 volts.....           |                               | 0.65 max                      | watt  |
| For grid-No.2 voltages between 150 and 300 volts..... |                               | See curve page 64             |       |
| GRID-NO.1 (CONTROL-GRID) VOLTAGE:                     |                               |                               |       |
| Negative bias value.....                              | 50 max                        | 50 max                        | volts |
| Positive bias value.....                              | 0 max                         | 0 max                         | volts |
| PEAK HEATER-CATHODE VOLTAGE:                          |                               |                               |       |
| Heater negative with respect to cathode.....          | 90 max                        | 90 max                        | volts |
| Heater positive with respect to cathode.....          | 90 max                        | 90 max                        | volts |

**Typical Operation (Pentode Connection):**

|  |                                |      |      |         |
|--|--------------------------------|------|------|---------|
| Plate Voltage.....                             | 100                            | 250  | 250  | volts   |
| Grid No.3 (Suppressor).....                    | Connected to cathode at socket |      |      |         |
| Grid-No.2 Voltage.....                         | 100                            | 125  | 150  | volts   |
| Cathode Resistor.....                          | 150                            | 100  | 68   | ohms    |
| Plate Resistance (Approx.).....                | 0.5                            | 1.5  | 1.0  | megohms |
| Transconductance.....                          | 3900                           | 4500 | 5200 | μmhos   |
| Grid-No.1 Bias for plate current of 10 μa..... | -4.2                           | -5.5 | -6.5 | volts   |
| Plate Current.....                             | 5.0                            | 7.6  | 10.6 | ma      |
| Grid-No. 2 Current.....                        | 2.1                            | 3.0  | 4.3  | ma      |

### Typical Operation (Triode Connection):†

|                      |      |       |
|----------------------|------|-------|
| Plate Voltage        | 250  | volts |
| Cathode Resistor     | 330  | ohms  |
| Amplification Factor | 36   |       |
| Plate Resistance     | 7500 | ohms  |
| Transconductance     | 4800 | μmhos |
| Plate Current        | 12.2 | ma    |

† Grid No. 2 and grid No. 3 tied to plate.

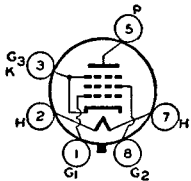
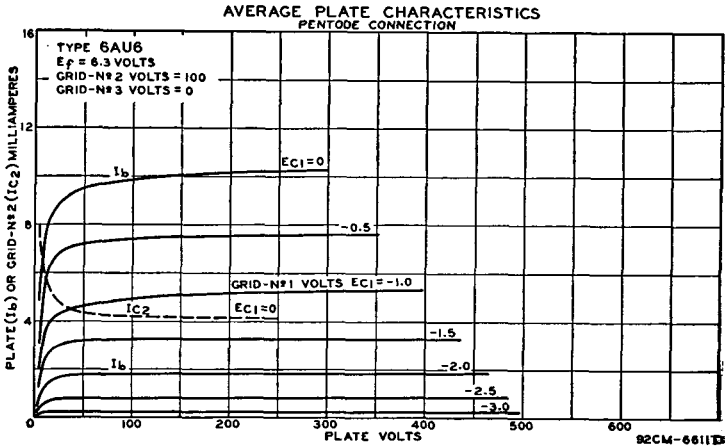

## BEAM POWER TUBE

Glass octal type used as a horizontal deflection amplifier in television receivers employing either transformer coupling or direct coupling to the deflecting yoke. Outline 22 or 23,

# 6AV5-GT

**OUTLINES SECTION.** Tube requires octal socket and may be mounted in any position.

|  |      |         |
|--|------|---------|
| HEATER VOLTAGE (AC/DC)                                 | 6.3  | volts   |
| HEATER CURRENT   | 1.2  | amperes |
| <b>DIRECT INTERELECTRODE CAPACITANCES (Approx.):</b>   |      |         |
| Grid No.1 to Plate                                     | 0.7  | μf      |
| Grid No.1 to Cathode, Heater, Grid No.2, and Grid No.3 | 14   | μf      |
| Plate to Cathode, Heater, Grid No.2, and Grid No.3     | 7.0  | μf      |
| TRANSCONDUCTANCE*                                      | 5500 | μmhos   |
| MU FACTOR, Grid No.2 to Grid No.1**                    | 4.3  |         |

\* Plate volts, 250; grid-No.2 volts, 150; grid-No.1 volts, -22.5.  
 \*\* Triode connected; plate and grid-No.2 volts, 150; grid-No.1 volts, -22.5.

### HORIZONTAL DEFLECTION AMPLIFIER For operation in a 525-line, 30-frame system

|   |           |       |
|---|-----------|-------|
| <b>Maximum Ratings:</b>                               |           |       |
| DC PLATE VOLTAGE                                      | 550 max   | volts |
| PEAK POSITIVE-PULSE PLATE VOLTAGE† (Absolute maximum) | 5500 max  | volts |
| PEAK NEGATIVE-PULSE PLATE VOLTAGE†                    | -1250 max | volts |
| DC GRID-NO.2 (SCREEN) VOLTAGE                         | 175 max   | volts |
| PEAK NEGATIVE-PULSE GRID-NO.1 (CONTROL-GRID) VOLTAGE† | -300 max  | volts |
| <b>CATHODE CURRENT:</b>                               |           |       |
| Peak  | 400 max   | ma    |
| DC  | 110 max   | ma    |
| GRID-NO.2 INPUT                                       | 2.5 max   | watts |
| PLATE DISSIPATION††                                   | 11 max    | watts |
| <b>PEAK HEATER-CATHODE VOLTAGE:</b>                   |           |       |
| Heater negative with respect to cathode               | 200 max   | volts |
| Heater positive with respect to cathode               | 200 max   | volts |
| BULB TEMPERATURE (At hottest point)                   | 210 max   | °C    |

**Maximum Circuit Value (For maximum rated conditions):**

- Grid-No.1 Circuit Resistance..... 0.47 *max* megohm
- † The duration of the voltage pulse must not exceed 15 per cent of one horizontal scanning cycle. In a 525-line, 30-frame system, 15 per cent of one horizontal scanning cycle is 10 microseconds.
- ° Under no circumstances should this absolute value be exceeded.
- ‡ An adequate bias resistor or other means is required to protect the tube in the absence of excitation.
- The dc component must not exceed 100 volts.

## TWIN DIODE— HIGH-MU TRIODE

# 6AV6

Miniature type used as combined detector, amplifier, and avc tube in automobile and ac-operated radio receivers. The 6AV6 may be substituted directly for the 6AT6 in applications

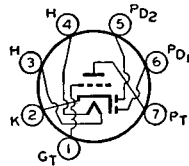

where the higher amplification of the 6AV6 is advantageous.

|  |                 |        |
|--|-----------------|--------|
| HEATER VOLTAGE (AC/DC).....                | 6.3             | volts  |
| HEATER CURRENT.....                        | 0.3             | ampere |
| <b>DIRECT INTERELECTRODE CAPACITANCES:</b> |                 |        |
| Triode Grid to Triode Plate.....           | 2.0             | μf     |
| Triode Grid to Cathode and Heater.....     | 2.2             | μf     |
| Triode Plate to Cathode and Heater.....    | 0.8             | μf     |
| Diode No.2 Plate to Triode Grid.....       | 0.04 <i>max</i> | μf     |

**Maximum Ratings: TRIODE UNIT AS CLASS A<sub>1</sub> AMPLIFIER**

|  |                |       |
|--|----------------|-------|
| PLATE VOLTAGE.....                           | 300 <i>max</i> | volts |
| GRID VOLTAGE, Positive Bias Value.....       | 0 <i>max</i>   | volts |
| PLATE DISSIPATION.....                       | 0.5 <i>max</i> | watt  |
| <b>PEAK HEATER-CATHODE VOLTAGE:</b>          |                |       |
| Heater negative with respect to cathode..... | 90 <i>max</i>  | volts |
| Heater positive with respect to cathode..... | 90 <i>max</i>  | volts |

**Characteristics:**

|                           |       |       |       |
|---------------------------|-------|-------|-------|
| Plate Voltage.....        | 100   | 250   | volts |
| Grid Voltage.....         | -1    | -2    | volts |
| Amplification Factor..... | 100   | 100   |       |
| Plate Resistance.....     | 80000 | 62500 | ohms  |
| Transconductance.....     | 1250  | 1600  | μmhos |
| Plate Current.....        | 0.50  | 1.2   | ma    |

**Maximum Rating:**

|                                |                |    |
|--------------------------------|----------------|----|
| <b>DIODE UNITS</b>             |                |    |
| PLATE CURRENT (Each Unit)..... | 1.0 <i>max</i> | ma |

The two diode plates are placed around a cathode, the sleeve of which is common to the triode unit. Each diode plate has its own base pin. Diode biasing of the triode unit is not recommended.

## INSTALLATION AND APPLICATION

Type 6AV6 requires miniature seven-contact socket and may be mounted in any position. Outline 13, OUTLINES SECTION.

When the heater is operated on ac with a transformer, the winding of the transformer which supplies the heater circuit should operate the heater at the recommended value for full-load operating conditions at average line voltage. Under any condition of operation, the heater voltage should not be allowed to rise more than 10% above the rated value. When the 6AV6 is used in automobile receivers, the heater terminals should be connected directly across a 6-volt battery.

In receivers that employ a series-heater connection, the heater of the 6AV6 may be operated in series with the heater of other types having the same heater-current rating. The current in the heater circuit of the 6AV6 should be adjusted to the rated value for the normal supply voltage. Refer to ELECTRON TUBE INSTALLATION SECTION, *Filament and Heater Power Supply*, for a discussion of arrangement of heaters in series-heater or "string" connection.

AVERAGE DIODE CHARACTERISTICS  
HALF-WAVE RECTIFICATION—SINGLE DIODE UNIT

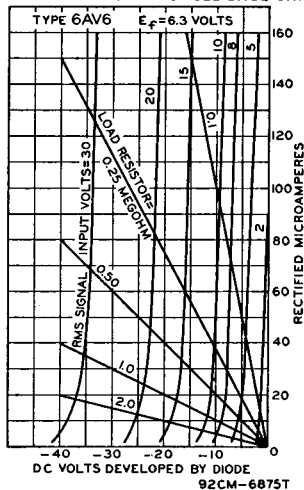

The cathode of the 6AV6 when operated from a transformer should preferably be connected directly to the electrical mid-point of the heater circuit. When operated in receivers employing a 6-volt storage battery for the heater supply, the cathode circuit is tied in either directly or through bias resistors to the negative side of the dc plate supply which is furnished either by the dc power line or the ac line through a rectifier. In circuits where the cathode is not connected directly to the heater, such as in a series-heater connection, the voltage difference between the heater and cathode should be kept within the tube ratings. If the use of a large resistor is necessary between the heater and cathode in some circuit designs, it should be bypassed by a suitable filter network or objectionable hum may develop.

The triode unit of the 6AV6 is recommended for use only in resistance-coupled circuits. Refer to the RESISTANCE-COUPLED AMPLIFIER SECTION, Chart 20 for typical operating conditions.

Grid bias for the triode unit of the 6AV6 may be obtained from a fixed source, such as a fixed-voltage tap on the dc power supply, or from a cathode-bias resistor. It should not be obtained by the diode-biasing method because of the probability of plate-current cutoff, even with relatively small signal voltages applied to the diode circuit.

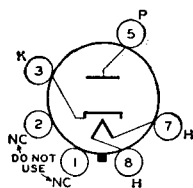
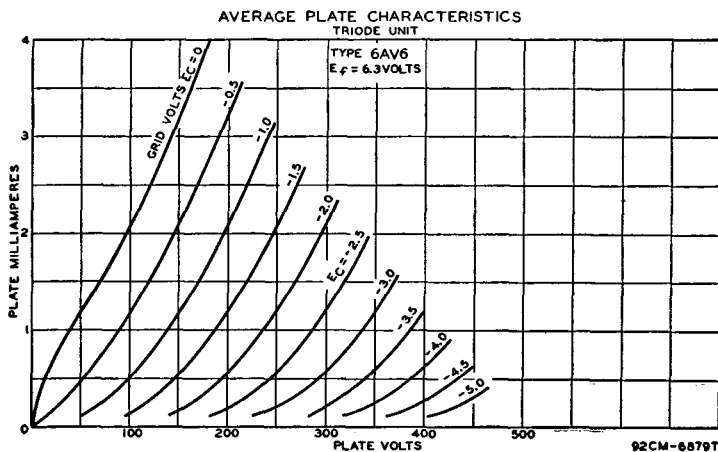

### HALF-WAVE VACUUM RECTIFIER

Glass octal type used as a damper tube in horizontal deflection circuits of television receivers. Outline 22, OUTLINES SECTION. This type may be supplied with pin No.1 omitted. Tube

## 6AX4-GT

requires octal socket and may be mounted in any position. It is especially important that this tube, like other power-handling tubes, be adequately ventilated. For curve of average plate characteristics, see page 61.

|                              |     |         |
|------------------------------|-----|---------|
| HEATER VOLTAGE (AC/DC) ..... | 6.3 | volts   |
| HEATER CURRENT .....         | 1.2 | amperes |

**Maximum Ratings:**

**DAMPER SERVICE**

|  |          |         |
|--|----------|---------|
| PEAK INVERSE PLATE VOLTAGE .....   | 4000 max | volts   |
| PEAK PLATE CURRENT .....   | 600 max  | ma      |
| HOT-SWITCHING TRANSIENT PLATE CURRENT:<br>For duration of 0.2 second max ..... | 3.0 max  | amperes |
| DC PLATE CURRENT .....   | 125 max  | ma      |

**PEAK HEATER-CATHODE VOLTAGE:**

|  |                 |       |
|--|-----------------|-------|
| Heater negative with respect to cathode..... | 4000 <i>max</i> | volts |
| Heater positive with respect to cathode..... | 100 <i>max</i>  | volts |

■ The dc component must not exceed 900 volts.

## 6AX5-GT

### FULL-WAVE VACUUM RECTIFIER

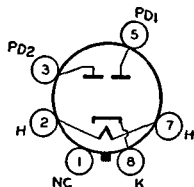

Glass octal type used in power supply of radio equipment having moderate dc requirements. The heater of this tube can be operated from the same transformer winding that supplies other 6.3-volt tubes in the receiver. In addition, because its heater-cathode construction gives the same heating time as that of other heater-cathode types in the receiver, use of the 6AX5-GT prevents excessive voltages from appearing across filter capacitors during warmup, and, as a result, permits the use of electrolytic filter capacitors having lower peak voltage ratings than required for a filament-type rectifier tube.

|                          |     |         |
|--------------------------|-----|---------|
| HEATER VOLTAGE (AC)..... | 6.3 | volts   |
| HEATER CURRENT.....      | 1.2 | amperes |

### FULL-WAVE RECTIFIER

**Maximum Ratings:**

|  |                         |         |
|--|-------------------------|---------|
| PEAK INVERSE PLATE VOLTAGE.....              | 1250 <i>max</i>         | volts   |
| PEAK PLATE CURRENT PER PLATE.....            | 375 <i>max</i>          | ma      |
| <b>HOT-SWITCHING TRANSIENT PLATE CURRENT</b> |                         |         |
| For duration of 0.2 second maximum.....      | 2.6 <i>max</i>          | amperes |
| AC PLATE SUPPLY VOLTAGE PER PLATE (RMS)..... | <i>See Rating Chart</i> |         |
| DC OUTPUT CURRENT PER PLATE (RMS).....       | <i>See Rating Chart</i> |         |
| <b>PEAK HEATER-CATHODE VOLTAGE:</b>          |                         |         |
| Heater negative with respect to cathode..... | 450 <i>max</i>          | volts   |
| Heater positive with respect to cathode..... | 450 <i>max</i>          | volts   |

**Typical Operation with Capacitor Input to Filter:**

|  |     |     |       |
|--|-----|-----|-------|
| AC Plate-to-Plate Supply Voltage (rms).....            | 700 | 900 | volts |
| Filter Input Capacitor*.....                           | 10  | 10  | μf    |
| Effective Plate-Supply Impedance Per Plate.....        | 50  | 105 | ohms  |
| <b>DC Output Voltage at Input to Filter (Approx.):</b> |     |     |       |
| At half-load current of { 62.5 ma .....                | 395 | -   | volts |
| { 40 ma .....  | -   | 540 | volts |
| At full-load current of { 125 ma .....                 | 350 | -   | volts |
| { 80 ma .....  | -   | 490 | volts |
| <b>Voltage Regulation (Approx.):</b>                   |     |     |       |
| Half-load to full-load current.....                    | 45  | 50  | volts |

**Typical Operation with Choke Input to Filter:**

|  |     |       |         |
|--|-----|-------|---------|
| AC Plate-to-Plate Supply Voltage (rms).....            | 700 | 900   | volts   |
| Filter Input Choke.....                                | 10# | 10# # | henries |
| <b>DC Output Voltage at Input to Filter (Approx.):</b> |     |       |         |
| At half-load current of { 75 ma .....                  | 270 | -     | volts   |
| { 62.5 ma .....  | -   | 365   | volts   |
| At full-load current of { 150 ma .....                 | 250 | -     | volts   |
| { 125 ma .....   | -   | 350   | volts   |
| <b>Voltage Regulation (Approx.):</b>                   |     |       |         |
| Half-load to full-load current.....                    | 20  | 15    | volts   |

\* Higher values of capacitance than indicated may be used but the effective plate-supply impedance may have to be increased to prevent exceeding the maximum rating for hot-switching transient plate current.

# This value is adequate to maintain optimum regulation in the region to the right of line L=10H on curve OPERATION CHARACTERISTICS With Choke Input to Filter, provided the load current is not less than 30 ma. For load currents less than 30 ma, a larger value of inductance is required for optimum regulation.

# # This value is adequate to maintain optimum regulation in the region to the right of line L=10H on curve OPERATION CHARACTERISTICS With Choke Input to Filter, provided the load current is not less than 35 ma. For load currents less than 35 ma, a larger value of inductance is required for optimum regulation.



## INSTALLATION AND APPLICATION

Type 6AX5-GT requires an octal socket and may be mounted in any position. Outline 22, OUTLINES SECTION. This type may be supplied with pin No.1 omitted. It is especially important that this tube, like other power-handling tubes, be adequately ventilated.

The *Rating Chart* presents graphically the relationships between maximum ac voltage input and maximum dc output current derived from the fundamental ratings for conditions of capacitor-input and choke-input filters. This graphical presentation provides for considerable latitude in choice of operating conditions.

The *Operation Characteristics* for a full-wave rectifier with capacitor-input filter show by means of boundary line "ADK" the limiting current and voltage relationships presented in the Rating Chart.

The *Operation Characteristics* for a full-wave rectifier with choke-input filter not only show by means of boundary line "CEK" the limiting current and voltage relationships presented in the Rating Chart, but also give information as to the effect on regulation of various sizes of chokes. The solid-line curves show the dc voltage outputs which would be obtained if the filter chokes had infinite inductance. The long-dash lines radiating from the zero position are boundary lines for various sizes of chokes as indicated. The intersection of one of these lines with a solid-line curve indicates the point on the curve at which the choke no longer behaves as though it had infinite inductance. To the left of the choke boundary line, the regulation curves depart from the solid-line curves as shown by the representative short-dash regulation curves.

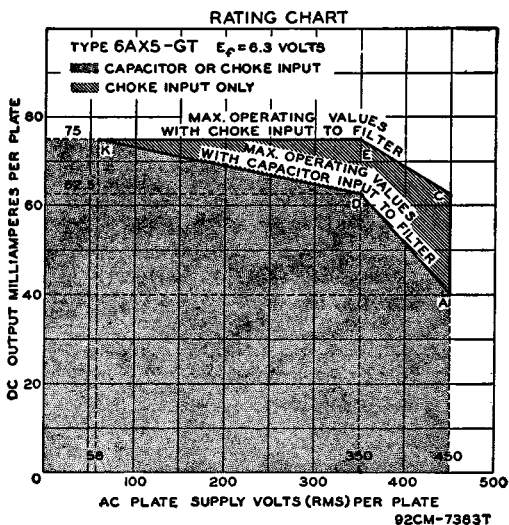

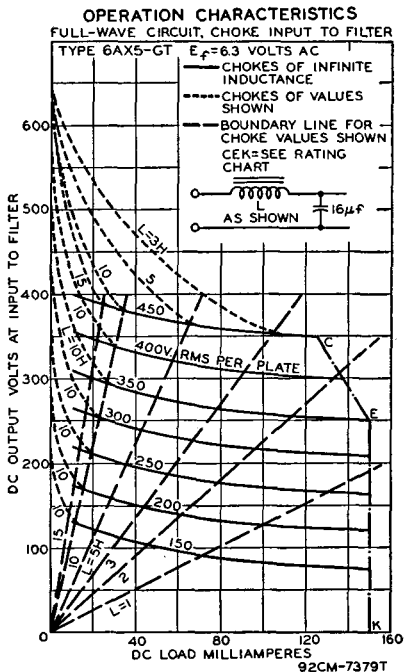
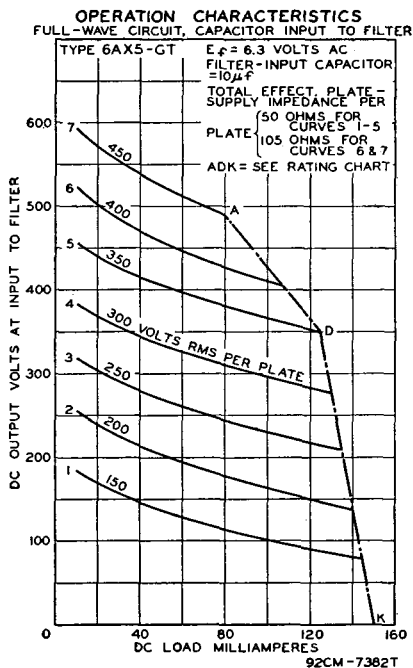

**POWER TRIODE**

Glass octal type used in output stage of radio receivers and amplifiers. Outline 42, OUTLINES SECTION. Tube requires octal socket and may be mounted in any position. For installation and application information, and typical operation as a single-tube class A amplifier, refer to type 2A3. Filament volts (ac/dc), 6.3; amperes, 1.0. Maximum ratings as push-

**6B4-G**

pull class AB<sub>1</sub> amplifier: plate volts, 325; plate dissipation, 15 watts. Type 6B4-G is used principally for renewal purposes.

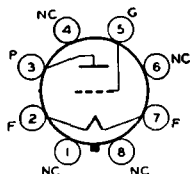

**PUSH-PULL CLASS AB<sub>1</sub> AMPLIFIER**

Typical Operation (Values are for Two Tubes):

|  | Fixed Bias | Cathode Bias |          |
|--|------------|--------------|----------|
| Plate Voltage                              | 325        | 325          | volts    |
| Grid Voltage*                              | -68        | -            | volts    |
| Cathode-Bias Resistor                      | -          | 850          | ohms     |
| Plate Current                              | 80         | 80           | ma       |
| Effective Load Resistance (Plate-to-plate) | 3000       | 5000         | ohms     |
| Total Harmonic Distortion                  | 2.5        | 5            | per cent |
| Power Output                               | 15         | 10           | watts    |

\* Grid voltage referred to mid-point of ac-operated filament.

**DIRECT-COUPLED POWER TRIODE**

Glass type used as class A<sub>1</sub> power amplifier. One triode, the driver, is directly connected within the tube to the second, or output, triode. Outline 38, OUTLINES SECTION. Tube requires six-contact socket. Heater volts (ac/dc), 6.3; amperes, 0.8. Characteristics of input and output triodes as class A<sub>1</sub> amplifier follow. Input triode: plate volts, 300 max; grid volts, 0; plate ma., 8. Output triode: plate volts, 300 max; plate ma., 45; plate resistance, 24000 ohms; load resistance, 7000 ohms; output watts, 4. This is a DISCONTINUED type listed for reference only.

**6B5**

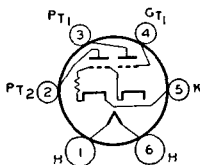

## TWIN-DIODE—HIGH-MU TRIODE

Glass octal type used as combined detector, amplifier, and avc tube. Outline 35, OUTLINES SECTION. Tube requires octal socket. Heater volts (ac/dc), 6.3; amperes, 0.3. Within its triode maximum plate-voltage rating of 250 volts, this type is similar electrically to type 6SQ7 and curves under that type apply to the 6B6-G. This is a DISCONTINUED type listed for reference only.

### 6B6-G

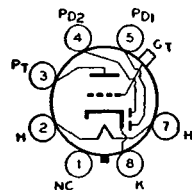

## TWIN-DIODE— REMOTE-CUTOFF PENTODE

Glass types used as combined detector, amplifier, and avc tubes. Outline 36, OUTLINES SECTION. These types fit the small seven-contact (0.75-inch, pin-circle diameter) socket. Except for interelectrode capacitances, the electrical characteristics of the 6B7 are identical with those of type 6B8-G. Type 6B7S has the external shield connected to the cathode. In

### 6B7 6B7S

general, its electrical characteristics are similar to those of the 6B7, but the two types are usually not directly interchangeable. These are DISCONTINUED types listed for reference only.

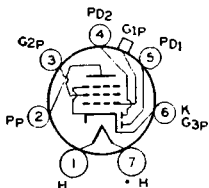

## TWIN-DIODE— REMOTE-CUTOFF PENTODE

Metal type 6B8 and glass octal type 6B8-G are used as combined detector, amplifier, and avc tubes. Outlines 4 and 35, respectively, OUTLINES SECTION. Type 6B8 is used principally for renewal purposes; 6B8-G is a DISCONTINUED type listed for reference only. Tubes require octal socket. Type 6B8-G requires complete shielding of detector circuits.

### 6B8 6B8-G

Heater volts (ac/dc), 6.3; amperes, 0.3. Maximum ratings of pentode unit as class A<sub>1</sub> amplifier: plate volts, 300 max; grid-No.2 (screen) volts, 125 max; grid-No.2 supply volts, 300 max; grid-No.1 volts, 0 min; plate dissipation, 3.0 max watts (6B8), 2.25 max watts (6B8-G); grid-No.2 input, 0.3 max watt. For typical operation as a resistance-coupled amplifier, refer to Chart 5, RESISTANCE-COUPLED AMPLIFIER SECTION.

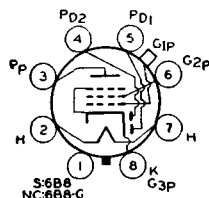

## REMOTE-CUTOFF PENTODE

Miniature type used as rf amplifier in standard broadcast and FM receivers, as well as in wide-band, high-frequency applications. This type is similar in performance to metal type

### 6BA6

6SG7. The low value of grid-No.1-to-plate capacitance minimizes regenerative effects, while the high transconductance makes possible high signal-to-noise ratio.

|   |            |        |
|---|------------|--------|
| HEATER VOLTAGE (AC/DC) .....  | 6.3        | volts  |
| HEATER CURRENT .....  | 0.3        | ampere |
| DIRECT INTERELECTRODE CAPACITANCES:   |            |        |
| Grid No.1 to Plate .....  | 0.0035 max | μf     |
| Grid No.1 to Cathode, Heater, Grid No.2, Grid No.3, and Internal Shield ..... | 5.5        | μf     |
| Plate to Cathode, Heater, Grid No.2, Grid No.3, and Internal Shield .....     | 5.0        | μf     |

### Maximum Ratings:

### CLASS A<sub>1</sub> AMPLIFIER

|  |                   |       |
|--|-------------------|-------|
| PLATE VOLTAGE .....                                    | 300 max           | volts |
| GRID-NO.2 (SCREEN) VOLTAGE .....                       | See curve page 64 |       |
| GRID-NO.2 SUPPLY VOLTAGE .....                         | 300 max           | volts |
| PLATE DISSIPATION .....                                | 3 max             | watts |
| GRID-NO.2 INPUT:                                       |                   |       |
| For grid-No.2 voltages up to 150 volts .....           | 0.6 max           | watt  |
| For grid-No.2 voltages between 150 and 300 volts ..... | See curve page 64 |       |
| GRID-NO.1 (CONTROL-GRID) VOLTAGE:                      |                   |       |
| Negative bias value .....                              | 50 max            | volts |
| Positive bias value .....                              | 0 max             | volts |
| PEAK HEATER-CATHODE VOLTAGE:                           |                   |       |
| Heater negative with respect to cathode .....          | 90 max            | volts |
| Heater positive with respect to cathode .....          | 90 max            | volts |

**Typical Operation:**

|  |                                |      |            |
|--|--------------------------------|------|------------|
| Plate Voltage .....  | 100                            | 250  | volts      |
| Grid No.3 (Suppressor) .....   | Connected to cathode at socket |      |            |
| Grid-No.2 Voltage .....  | 100                            | 100  | volts      |
| Cathode-Bias Resistor .....  | 68                             | 68   | ohms       |
| Plate Resistance (Approx.) .....                                     | 0.25                           | 1.0  | megohm     |
| Transconductance .....   | 4300                           | 4400 | $\mu$ mhos |
| Grid-No.1 Bias (Approx.) for transconductance of 40 $\mu$ mhos ..... | -20                            | -20  | volts      |
| Plate Current .....  | 10.8                           | 11   | ma         |
| Grid-No.2 Current .....  | 4.4                            | 4.2  | ma         |

**INSTALLATION AND APPLICATION**

Type 6BA6 requires miniature seven-contact socket and may be mounted in any position. Outline 13, OUTLINES SECTION. For heater and cathode considerations, refer to type 6AV6.

Control-grid bias variation will be found effective in changing the volume of the receiver. In order to obtain adequate volume control, an available grid-No.1-bias voltage of approximately 50 volts will be required. The exact value will depend upon the circuit design and operating conditions. This voltage may be obtained, depending on the receiver requirements, from a potentiometer across a fixed supply voltage, from a variable cathode-bias resistor, from the avc system, or from a combination of these methods.

The grid-No. 2 (screen) voltage may be obtained from a potentiometer or bleeder circuit across the B-supply source, or through a dropping resistor from the plate supply. The use of series resistors for obtaining satisfactory control of grid-No.2 voltage in the case of four-electrode tubes is usually impossible because of secondary-emission phenomena. In the 6BA6, however, because grid No.3 practically removes these effects, it is practical to obtain grid-No.2 voltage through a series-dropping resistor from the plate supply or from some high intermediate voltage, provided the source does not exceed the plate-supply voltage. With this method, the grid-No.2-to-cathode voltage will fall off very little from minimum to maximum value of the resistor controlling cathode bias. In some cases, it may actually rise. This rise of grid-No.2-to-cathode voltage above the normal maximum value is allowable because both the grid-No.2 current and the plate current are reduced simultaneously by a sufficient amount to prevent damage to the tube. It should be recognized that, in general, the series-resistor method of obtaining grid-No.2 voltage from a higher voltage supply necessitates the use of the variable cathode-resistor method of controlling volume in order to prevent too high a voltage on grid No.2. When grid-No.2 and control-grid voltage are obtained in this manner, the remote "cutoff" advantage of the 6BA6 can be fully realized. However, it should be noted that the use of a resistor in the grid-No.2 circuit will have

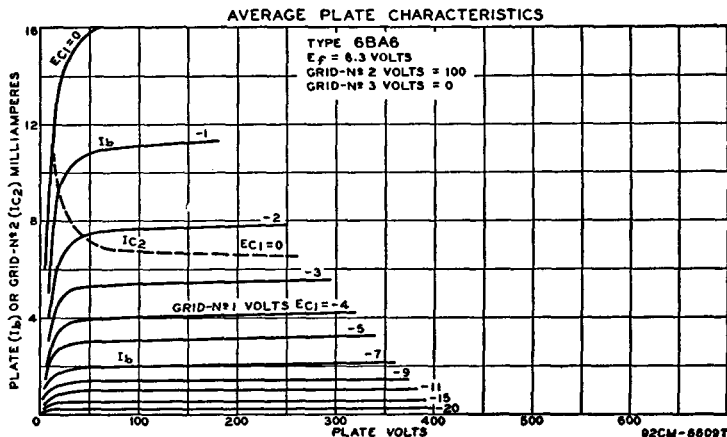

an effect on the change in plate resistance with variation in grid-No.3 (suppressor) voltage in case grid No.3 is utilized for control purposes.

**Grid No. 3 (suppressor)** may be connected directly to the cathode or it may be made negative with respect to the cathode. For the latter condition, the grid-No.3 voltage may be obtained from a potentiometer or bleeder circuit, or from the avc system.

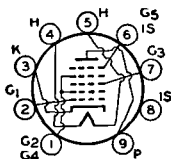

### PENTAGRID CONVERTER

# 6BA7

Miniature type used as converter in superheterodyne circuits especially those for the FM broadcast band. Outline 17, OUTLINES SECTION. Tube requires novel nine-contact socket and

may be mounted in any position. Its characteristics are similar to those of metal type 6SB7-Y. For heater and cathode considerations, refer to type 6AV6.

|                              |     |        |
|------------------------------|-----|--------|
| HEATER VOLTAGE (AC/DC) ..... | 6.3 | volts  |
| HEATER CURRENT .....         | 0.3 | ampere |

**DIRECT INTERELECTRODE CAPACITANCES:**

|  |          |                  |
|--|----------|------------------|
| Grid No.3 to All Other Electrodes (RF Input) .....         | 9.5      | $\mu\mu\text{f}$ |
| Plate to All Other Electrodes (Mixer Output) .....         | 8.3      | $\mu\mu\text{f}$ |
| Grid No.1 to All Other Electrodes (Oscillator Input) ..... | 6.7      | $\mu\mu\text{f}$ |
| Grid No.3 to Plate .....                                   | 0.19 max | $\mu\mu\text{f}$ |
| Grid No.1 to Grid No.3 .....                               | 0.1 max  | $\mu\mu\text{f}$ |
| Grid No.1 to Plate .....                                   | 0.05 max | $\mu\mu\text{f}$ |
| Grid No.1 to All Other Electrodes Except Cathode .....     | 3.4      | $\mu\mu\text{f}$ |
| Grid No.1 to Cathode .....                                 | 3.3      | $\mu\mu\text{f}$ |
| Cathode to All Other Electrodes Except Grid No.1 .....     | 4.0      | $\mu\mu\text{f}$ |

**Maximum Ratings:**

**CONVERTER SERVICE**

|  |         |       |
|--|---------|-------|
| PLATE VOLTAGE .....  | 300 max | volts |
| GRID-NO.5-AND-INTERNAL-SHIELD VOLTAGE $\blacktriangle$ ..... | 0 max   | volts |
| GRIDS-NO.2-AND-NO.4 (SCREEN) VOLTAGE .....                   | 100 max | volts |
| GRIDS-NO.2-AND-NO.4 SUPPLY VOLTAGE .....                     | 300 max | volts |
| PLATE DISSIPATION .....                                      | 2.0 max | watts |
| GRIDS-NO.2-AND-NO.4 INPUT .....                              | 1.5 max | watts |
| TOTAL CATHODE CURRENT .....                                  | 22 max  | ma    |
| GRID-NO.3 VOLTAGE:   |         |       |
| Negative bias value .....                                    | 100 max | volts |
| Positive bias value .....                                    | 0 max   | volts |
| PEAK HEATER-CATHODE VOLTAGE:                                 |         |       |
| Heater negative with respect to cathode .....                | 90 max  | volts |
| Heater positive with respect to cathode .....                | 90 max  | volts |

**Characteristics (Separate Excitation):\***

|  |                              |       |                  |
|--|------------------------------|-------|------------------|
| Plate Voltage .....                                  | 100                          | 250   | volts            |
| Grid No.5 and Internal Shield $\blacktriangle$ ..... | Connected directly to ground |       |                  |
| Grids-No.2-and-No.4 (Screen) Voltage .....           | 100                          | 100   | volts            |
| Grid-No.3 (Control-Grid) Voltage .....               | -1.0                         | -1.0  | volt             |
| Grid-No.1 (Oscillator-Grid) Resistor .....           | 20000                        | 20000 | ohms             |
| Plate Resistance (Approx.) .....                     | 0.5                          | 1.0   | megohm           |
| Conversion Transconductance .....                    | 900                          | 950   | $\mu\text{mhos}$ |
| Conversion Transconductance (Approx.)** .....        | 3.5                          | 3.5   | $\mu\text{mhos}$ |
| Plate Current .....                                  | 3.6                          | 3.8   | ma               |
| Grids-No 2-and-No.4 Current .....                    | 10.2                         | 10    | ma               |
| Grid-No.1 Current .....                              | 0.35                         | 0.35  | ma               |
| Total Cathode Current .....                          | 14.2                         | 14.2  | ma               |

NOTE: The transconductance between grid No.1 and grids No.2 and No.4 connected to plate (not oscillating) is approximately 8000  $\mu\text{mhos}$  under the following conditions: signal applied to grid No.1 at zero bias; grids No.2 and No.4 and plate at 100 volts; grid No.3 grounded. Under the same conditions, the plate current is 32 milliamperes, and the amplification factor is 16.5.

\*The characteristics shown with separate excitation correspond very closely with those obtained in a self-excited oscillator circuit operating with zero bias.

\*\*With grid-No.3 bias of -20 volts.

$\blacktriangle$ Internal Shield (pins No.6 and No.8) connected directly to ground.

# 6BC4

## UHF MEDIUM-MU TRIODE

Miniature type used as an rf amplifier in the cathode-drive circuits of uhf television tuners covering the frequency range of 470 to 890 megacycles per second. Outline 10, OUTLINES

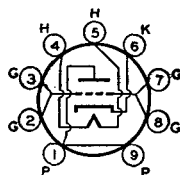

SECTION. Tube requires miniature nine-contact socket and may be mounted in any position.

|   |       |               |
|---|-------|---------------|
| HEATER VOLTAGE (AC/DC) .....                  | 6.3   | volts         |
| HEATER CURRENT .....                          | 0.225 | ampere        |
| DIRECT INTERELECTRODE CAPACITANCES (Approx.): |       |               |
| Grid to Plate .....                           | 1.6   | $\mu\text{f}$ |
| Grid to Heater and Cathode .....              | 2.9   | $\mu\text{f}$ |
| Plate to Heater and Cathode .....             | 0.26  | $\mu\text{f}$ |
| Heater to Cathode .....                       | 2.7   | $\mu\text{f}$ |

### CLASS A<sub>1</sub> AMPLIFIER

#### Maximum Ratings:

|   |                |       |
|---|----------------|-------|
| PLATE VOLTAGE .....                           | 250 <i>max</i> | volts |
| PLATE DISSIPATION .....                       | 2.5 <i>max</i> | watts |
| CATHODE CURRENT .....                         | 25 <i>max</i>  | ma    |
| PEAK HEATER-CATHODE VOLTAGE:                  |                |       |
| Heater negative with respect to cathode ..... | 75 <i>max</i>  | volts |
| Heater positive with respect to cathode ..... | 75 <i>max</i>  | volts |

#### Characteristics:

|   |       |                  |
|---|-------|------------------|
| Plate Supply Voltage .....                                      | 150   | volts            |
| Cathode-Bias Resistor .....                                     | 100   | ohms             |
| Amplification Factor .....                                      | 48    |                  |
| Plate Resistance .....  | 4800  | ohms             |
| Transconductance .....  | 10000 | $\mu\text{mhos}$ |
| Grid Bias (Approx.) for plate current of 10 $\mu\text{a}$ ..... | -10   | volts            |
| Plate Current .....   | 14.5  | ma               |

#### Maximum Circuit Value (For maximum rated conditions):

|                                  |                       |
|----------------------------------|-----------------------|
| Grid-Circuit Resistance:         |                       |
| For fixed-bias operation .....   | Not recommended       |
| For cathode-bias operation ..... | 0.5 <i>max</i> megohm |

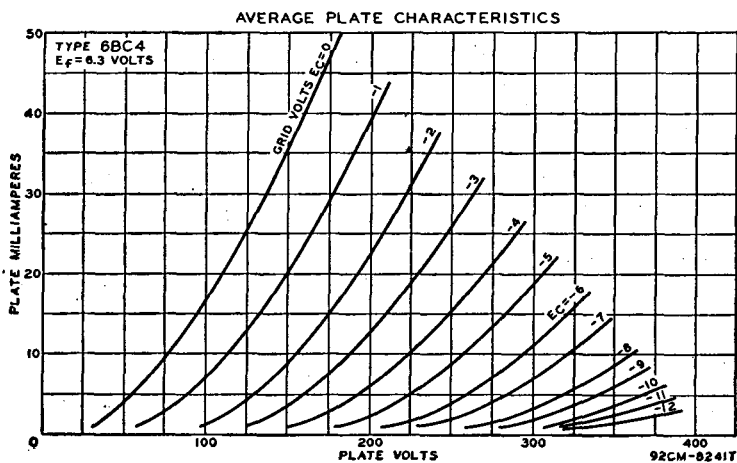

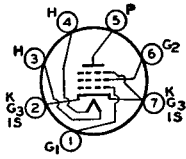

### SHARP-CUTOFF PENTODE

Miniature type used in compact radio equipment as an rf or if amplifier at frequencies up to 400 megacycles per second. Outline 13, OUTLINES SECTION. Tube requires miniature seven-contact socket and may be mounted in any position. Except for a slightly higher transconductance, this type is similar electrically to type 6AG5. Heater volts (ac/dc), 6.3; amperes, 0.3. For heater and cathode considerations, refer to type 6AV6.

## 6BC5

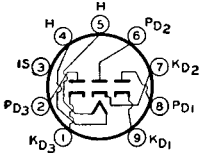

### TRIPLE DIODE

Miniature type containing three high-perveance diode units in one envelope used in dc restorer circuits of color television receivers. Also used in AM/FM radio receivers as a combination FM discriminator and AM detector tube. Outline 14, OUTLINES SECTION. Tube requires nine-contact miniature socket and may be mounted in any position.

## 6BC7

|  |       |        |
|--|-------|--------|
| HEATER VOLTAGE (AC/DC).....                                  | 6.3   | volts  |
| HEATER CURRENT.....  | 0.450 | ampere |
| DIRECT INTERELECTRODE CAPACITANCES (Approx.):                |       |        |
| Plate No.1 to Cathode No.1, Heater, and Internal Shield..... | 3.5   | μf     |
| Plate No.2 to Cathode No.2, Heater, and Internal Shield..... | 5.5   | μf     |
| Plate No.3 to Cathode No.3, Heater, and Internal Shield..... | 3.5   | μf     |

#### Maximum Ratings (Each Diode Unit):

|  |         |       |
|--|---------|-------|
| PEAK INVERSE PLATE VOLTAGE.....              | 300 max | volts |
| PEAK PLATE CURRENT*.....                     | 54 max  | ma    |
| DC OUTPUT CURRENT.....                       | 12 max  | ma    |
| PEAK HEATER-CATHODE VOLTAGE:                 |         |       |
| Heater negative with respect to cathode..... | 200 max | volts |
| Heater positive with respect to cathode..... | 200 max | volts |

\* In rectifier service, the minimum total effective plate-supply impedance per plate is 560 ohms.

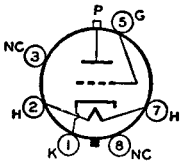

### SHARP-CUTOFF BEAM TRIODE

Glass octal types used for the voltage regulation of high-voltage, low-current dc power supplies in color television receivers. Outline 32, OUTLINES SECTION. Tubes require octal socket and may be mounted in any position. Type 6BD4, which is a DISCONTINUED type listed for reference only, has a maximum dc plate voltage of 20000 volts, a maximum unregulated dc supply voltage of 40000 volts, and a maximum plate dissipation of 20 watts.

## 6BD4 6BD4-A

|                                     |          |        |
|-------------------------------------|----------|--------|
| HEATER VOLTAGE (AC/DC).....         | 6.3      | volts  |
| HEATER CURRENT.....                 | 0.6      | ampere |
| DIRECT INTERELECTRODE CAPACITANCES: |          |        |
| Grid to Plate.....                  | 1.0      | μf     |
| Grid to Cathode and Heater.....     | 3.8      | μf     |
| Plate to Cathode and Heater.....    | 0.04 max | μf     |
| AMPLIFICATION FACTOR.....           | 1650     |        |

#### VOLTAGE-CONTROL SERVICE

|                                    |           |       |
|------------------------------------|-----------|-------|
| Maximum Ratings:                   |           |       |
| DC PLATE VOLTAGE.....              | 27000 max | volts |
| UNREGULATED DC SUPPLY VOLTAGE..... | 55000 max | volts |

6BD4-A

|  |          |       |
|--|----------|-------|
| <b>GRID VOLTAGE:</b>                         |          |       |
| DC Value.....                                | -125 max | volts |
| Peak Value.....                              | -550 max | volts |
| <b>DC PLATE CURRENT:</b>                     |          |       |
| .....  | 1.5 max  | ma    |
| <b>PLATE DISSIPATION:</b>                    |          |       |
| .....  | 25 max   | watts |
| <b>PEAK HEATER-CATHODE VOLTAGE:</b>          |          |       |
| Heater negative with respect to cathode..... | 180 max  | volts |
| Heater positive with respect to cathode..... | 180 max  | volts |

**Maximum Circuit Value:**

**Grid-Circuit Resistance:**

With unregulated supply having an equivalent resistance of at least 8 megohms 4\*max megohms

\* This value must be reduced if the equivalent resistance of the unregulated supply is less than 8 megohms.

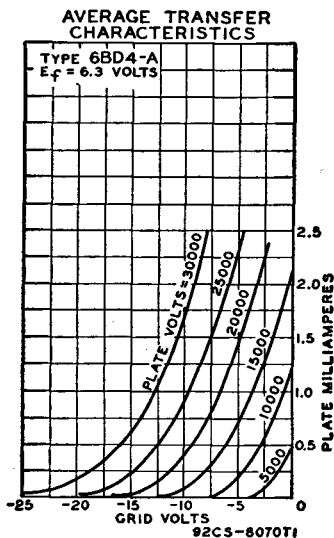

## REMOTE-CUTOFF PENTODE

# 6BD6

Miniature type used as rf or if amplifier in radio receivers. This type is similar in performance to metal type 6SK7. Outline 13, OUTLINES SECTION. Tube requires miniature seven-

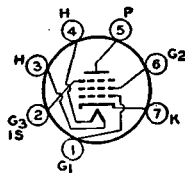

contact socket and may be mounted in any position. For heater considerations, refer to type 6AV6.

|   |           |        |
|---|-----------|--------|
| HEATER VOLTAGE (AC/DC).....   | 6.3       | volts  |
| HEATER CURRENT.....   | 0.8       | ampere |
| <b>DIRECT INTERELECTRODE CAPACITANCES:</b>                                  |           |        |
| Grid No.1 to Plate.....   | 0.005 max | μf     |
| Grid No.1 to Cathode, Heater, Grid No.2, Grid No.3, and Internal Shield.... | 4.3       | μf     |
| Plate to Cathode, Heater, Grid No.2, Grid No.3, and Internal Shield.....    | 5.0       | μf     |

**Maximum Ratings:**

**CLASS A<sub>1</sub> AMPLIFIER**

|  |          |       |
|--|----------|-------|
| PLATE VOLTAGE.....                           | 300 max  | volts |
| GRID-NO.2 (SCREEN) VOLTAGE.....              | 125 max  | volts |
| PLATE DISSIPATION.....                       | 3.0 max  | watts |
| GRID-NO.2 INPUT.....                         | 0.65 max | watt  |
| TOTAL CATHODE CURRENT.....                   | 14 max   | ma    |
| <b>PEAK HEATER-CATHODE VOLTAGE:</b>          |          |       |
| Heater negative with respect to cathode..... | 90 max   | volts |
| Heater positive with respect to cathode..... | 90 max   | volts |



## Typical Operation:

|  |                                |      |      |            |
|--|--------------------------------|------|------|------------|
| Plate Voltage  | 100                            | 125  | 250  | volts      |
| Grid-No.3 (Suppressor)   | Connected to cathode at socket |      |      |            |
| Grid-No.2 Voltage  | 100                            | 125  | 100  | volts      |
| Grid-No.1 (Control-Grid) Voltage                               | -1                             | -3   | -3   | volts      |
| Plate Resistance (Approx.)                                     | 0.15                           | 0.18 | 0.8  | megohm     |
| Transconductance   | 2550                           | 2350 | 2000 | $\mu$ mhos |
| Grid-No.1 Bias (Approx.) for transconductance of 10 $\mu$ mhos | -35                            | -45  | -35  | volts      |
| Plate Current  | 13                             | 13   | 9    | ma         |
| Grid-No.2 Current  | 5                              | 5    | 3    | ma         |

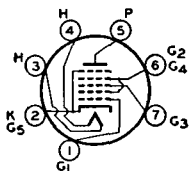

## PENTAGRID CONVERTER

Miniature type used as converter in superheterodyne circuits in both the standard broadcast and FM bands. The 6BE6 is similar in performance to metal type 6SA7. For general discus-

# 6BE6

sion of pentagrid types, see *Frequency Conversion* in ELECTRON TUBE APPLICATION SECTION.

|                        |     |        |
|------------------------|-----|--------|
| HEATER VOLTAGE (AC/DC) | 6.3 | volts  |
| HEATER CURRENT         | 0.3 | ampere |

### DIRECT INTERELECTRODE CAPACITANCES:

|  | Without<br>External<br>Shield | With<br>External<br>Shield |         |
|--|-------------------------------|----------------------------|---------|
| Grid No.3 to Plate   | 0.30 max                      | 0.25 max                   | $\mu$ f |
| Grid No.3 to Grid No.1   | 0.15 max                      | 0.15 max                   | $\mu$ f |
| Grid No.1 to Plate   | 0.10 max                      | 0.05 max                   | $\mu$ f |
| Grid No.3 to All Other Electrodes                              | 7.0 max                       | 7.0 max                    | $\mu$ f |
| Grid No.1 to All Other Electrodes                              | 5.5 max                       | 5.5 max                    | $\mu$ f |
| Plate to All Other Electrodes                                  | 8.0                           | 13.0                       | $\mu$ f |
| Grid No.1 to Cathode and Grid No.5                             | 3.0                           | 3.0                        | $\mu$ f |
| Cathode and Grid No.5 to All Other Electrodes except Grid No.1 | 15.0                          | 20.0                       | $\mu$ f |

### Maximum Ratings:

### CONVERTER SERVICE

|   |         |       |
|---|---------|-------|
| PLATE VOLTAGE                           | 300 max | volts |
| GRIDS-NO.2-AND-NO.4 (SCREEN) VOLTAGE    | 100 max | volts |
| GRIDS-NO.2-AND-NO.4 SUPPLY VOLTAGE      | 300 max | volts |
| PLATE DISSIPATION                       | 1.0 max | watt  |
| GRIDS-NO 2-AND-NO.4 INPUT               | 1.0 max | watt  |
| TOTAL CATHODE CURRENT                   | 14 max  | ma    |
| GRID-NO.3 VOLTAGE:                      |         |       |
| Negative bias value                     | 50 max  | volts |
| Positive bias value                     | 0 max   | volts |
| PEAK HEATER-CATHODE VOLTAGE:            |         |       |
| Heater negative with respect to cathode | 90 max  | volts |
| Heater positive with respect to cathode | 90 max  | volts |

### Typical Operation (Separate Excitation):\*

|   |       |       |            |
|---|-------|-------|------------|
| Plate Voltage   | 100   | 250   | volts      |
| Grids-No.2-and-No.4 (Screen) Voltage                                | 100   | 100   | volts      |
| Grid-No.1 (Oscillator-Grid) Voltage (rms)                           | 10    | 10    | volts      |
| Grid-No.3 (Control-Grid) Voltage                                    | -1.5  | -1.5  | volts      |
| Grid-No.1 (Oscillator-Grid) Resistor                                | 20000 | 20000 | ohms       |
| Plate Resistance (Approx.)  | 0.4   | 1.0   | megohm     |
| Conversion Transconductance   | 455   | 475   | $\mu$ mhos |
| Grid-No. 3 Voltage for conversion transconductance of 10 $\mu$ mhos | -30   | -30   | volts      |
| Plate Current   | 2.6   | 2.9   | ma         |
| Grids-No.2-and-No.4 Current   | 7.0   | 6.8   | ma         |
| Grid-No.1 Current   | 0.5   | 0.5   | ma         |
| Total Cathode Current   | 10.1  | 10.2  | ma         |

Note: The transconductance between grid No.1 and grids No.2 and No.4 connected to plate (not oscillating) is approximately 7250  $\mu$ mhos under the following conditions: grids No.1 and No.3 at 0 volts; grids No.2 and No.4 and plate at 100 volts. Under the same conditions, the plate current is 25 ma., and the amplification factor is 20.

\* The characteristics shown with separate excitation correspond very closely with those obtained in a self-excited oscillator circuit operating with zero bias.

## INSTALLATION AND APPLICATION

Type 6BE6 requires miniature seven-contact socket and may be mounted in any position. Outline 13, OUTLINES SECTION. For heater and cathode considerations, refer to type 6AV6.

Because of the special structural arrangement of the 6BE6, a change in signal-grid voltage produces little change in cathode current. Consequently, an rf voltage on the signal grid produces little modulation of the electron current flowing in the cathode circuit. This feature is important because it is desirable that the impedance in the cathode circuit should produce little degeneration or regeneration of the signal-frequency input and intermediate-frequency output. Another important feature is that, because signal-grid voltage has very little effect on the space charge near the cathode, changes in avc bias produce little change in oscillator transconductance and in the input capacitance of grid No.1. There is, therefore, little detuning of the oscillator by avc bias.

A typical self-excited oscillator circuit employing the 6BE6 is given in the CIRCUIT SECTION.

In the 6BE6 operation characteristics curves with self-excitation,  $E_k$  is the voltage across the oscillator-coil section between cathode and ground;  $E_g$  is the oscillator voltage between cathode and grid.

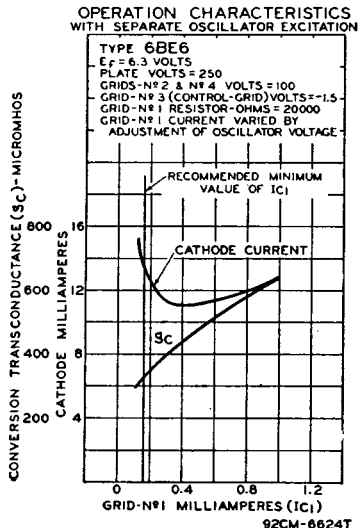
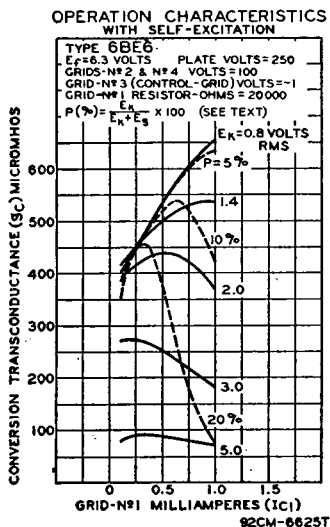

### BEAM POWER TUBE

Miniature type used in audio output stage of television and radio receivers. Triode-connected, it is used as a vertical deflection amplifier in television receivers. Outline 16, OUTLINES SECTION. Tube requires miniature seven-contact socket and may be mounted in any position. This type is used principally for renewal purposes.

## 6BF5

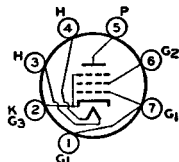

|  |      |                  |
|--|------|------------------|
| HEATER VOLTAGE (AC/DC) .....                                 | 6.3  | volts            |
| HEATER CURRENT .....   | 1.2  | amperes          |
| <b>DIRECT INTERELECTRODE CAPACITANCES (Approx.):</b>         |      |                  |
| Grid No.1 to Plate .....                                     | 0.65 | $\mu\mu\text{f}$ |
| Grid No.1 to Cathode, Heater, Grid No.2, and Grid No.3 ..... | 14   | $\mu\mu\text{f}$ |
| Plate to Cathode, Heater, Grid No.2, and Grid No.3 .....     | 6    | $\mu\mu\text{f}$ |

# RCA Receiving Tube Manual

|   |                                      |       |
|---|--------------------------------------|-------|
| <b>Maximum Ratings:</b>                       | <b>CLASS A<sub>1</sub> AMPLIFIER</b> |       |
| PLATE VOLTAGE.....                            | 250 <i>max</i>                       | volts |
| GRID-NO.2 (SCREEN) VOLTAGE.....               | 250 <i>max</i>                       | volts |
| PLATE DISSIPATION.....                        | 5.5 <i>max</i>                       | watts |
| GRID-NO.2 INPUT.....                          | 1.25 <i>max</i>                      | watts |
| <b>PEAK HEATER-CATHODE VOLTAGE:</b>           |                                      |       |
| Heater negative with respect to cathode.....  | 200 <i>max</i>                       | volts |
| Heater positive with respect to cathode.....  | 200 <i>max</i>                       | volts |
| ■ The dc component must not exceed 100 volts. |                                      |       |

|                                       |       |          |
|---------------------------------------|-------|----------|
| <b>Characteristics:</b>               |       |          |
| Plate Voltage.....                    | 110   | volts    |
| Grid-No.2 (Screen) Voltage.....       | 110   | volts    |
| Grid-No.1 (Control-Grid) Voltage..... | -7.5  | volts    |
| Peak AF Grid-No.1 Voltage.....        | 7.5   | volts    |
| Zero-Signal Plate Current.....        | 49    | ma       |
| Maximum-Signal Plate Current.....     | 50    | ma       |
| Zero-Signal Grid-No.2 Current.....    | 4     | ma       |
| Maximum-Signal Grid-No.2 Current..... | 8.5   | ma       |
| Plate Resistance (Approx.).....       | 10000 | ohms     |
| Transconductance.....                 | 7500  | μmhos    |
| Plate Load Resistance.....            | 2500  | ohms     |
| Total Harmonic Distortion.....        | 9     | per cent |
| Maximum-Signal Power Output.....      | 1.9   | watts    |

## TWIN DIODE— MEDIUM-MU TRIODE

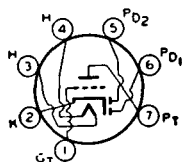

Miniature type used in compact radio equipment as combined detector, amplifier, and avc tube. The triode unit is particularly useful as a driver for impedance- or transformer-coupled

# 6BF6

output stages in automobile receivers. It is equivalent in performance to metal type 6SR7. Outline 13, OUTLINES SECTION. Tube requires miniature seven-contact socket and may be mounted in any position. For typical operation as a resistance-coupled amplifier, refer to Chart 9, RESISTANCE-COUPLED AMPLIFIER SECTION. For heater and cathode considerations, refer to type 6AV6.

|  |  |                                     |
|--|--|-------------------------------------|
| HEATER VOLTAGE (AC/DC).....                  | 6.3                                    | volts                               |
| HEATER CURRENT.....                          | 0.3                                    | ampere                              |
| <b>DIRECT INTERELECTRODE CAPACITANCES:</b>   |  |                                     |
|  | <i>Without<br/>External<br/>Shield</i> | <i>With<br/>External<br/>Shield</i> |
| Triode Grid to Triode Plate.....             | 2.0                                    | 2.0                                 |
| Triode Grid to Cathode.....                  | 1.8                                    | 1.8                                 |
| Triode Plate to Cathode.....                 | 1.1                                    | 0.8                                 |
| Plate of Diode Unit No.1 to Cathode.....     | 1.4                                    | 0.7                                 |
| Plate of Diode Unit No.2 to Cathode.....     | 1.5                                    | 0.1                                 |
| Plate of Diode Unit No.1 to Triode Grid..... | 0.06 <i>max</i>                        | 0.07 <i>max</i>                     |
| Plate of Diode Unit No.2 to Triode Grid..... | 0.05 <i>max</i>                        | 0.06 <i>max</i>                     |

|  |   |       |
|--|---|-------|
| <b>Maximum Ratings:</b>                      | <b>TRIODE UNIT AS CLASS A<sub>1</sub> AMPLIFIER</b> |       |
| PLATE VOLTAGE.....                           | 300 <i>max</i>                                      | volts |
| PLATE DISSIPATION.....                       | 2.5 <i>max</i>                                      | watts |
| <b>PEAK HEATER-CATHODE VOLTAGE:</b>          |   |       |
| Heater negative with respect to cathode..... | 90 <i>max</i>                                       | volts |
| Heater positive with respect to cathode..... | 90 <i>max</i>                                       | volts |

|   |       |          |
|---|-------|----------|
| <b>Typical Operation (With Transformer Coupling):</b> |       |          |
| Plate Voltage.....                                    | 250   | volts    |
| Grid Voltage.....                                     | -9    | volts    |
| Amplification Factor.....                             | 16    |          |
| Plate Resistance.....                                 | 8500  | ohms     |
| Transconductance.....                                 | 1900  | μmhos    |
| Plate Current.....                                    | 9.5   | ma       |
| Load Resistance.....                                  | 10000 | ohms     |
| Total Harmonic Distortion.....                        | 6.5   | per cent |
| Power Output.....                                     | 300   | mw       |

### DIODE UNITS

The two diode plates and the triode unit have a common cathode. Diode biasing of the triode unit of the 6BF6 is not suitable. For diode operation curves, refer to type 6AV6.

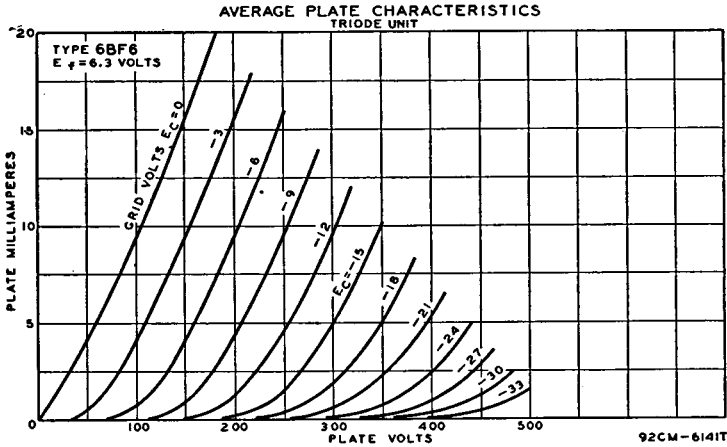

**BEAM POWER TUBE**

**6BG6-G**

Glass octal type used as output amplifier in horizontal-deflection circuits of television equipment and other applications where high pulse voltages occur during short duty cycles. Out-

line 44, **OUTLINES SECTION**. Tube requires octal socket. Vertical tube mounting is preferred but horizontal operation is permissible if pins No.2 and 7 are in vertical plane.

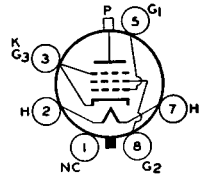

|   |                 |                  |
|---|-----------------|------------------|
| HEATER VOLTAGE (AC/DC).....                                 | 6.3             | volts            |
| HEATER CURRENT.....   | 0.9             | ampere           |
| <b>DIRECT INTERELECTRODE CAPACITANCES:</b>                  |                 |                  |
| Grid No.1 to Plate.....                                     | 0.34 <i>max</i> | $\mu\mu\text{f}$ |
| Grid No.1 to Cathode, Heater, Grid No.2, and Grid No.3..... | 12              | $\mu\mu\text{f}$ |
| Plate to Cathode, Heater, Grid No.2, and Grid No.3.....     | 6.5             | $\mu\mu\text{f}$ |
| <b>TRANSCONDUCTANCE*</b> .....                              | 6000            | $\mu\text{mhms}$ |
| <b>MU-FACTOR, Grid No.2 to Grid No.1<sup>o</sup></b> .....  | 8.0             |                  |

<sup>o</sup> For plate and grid-No.2 volts, 250; grid-No.1 volts, -15.

**HORIZONTAL DEFLECTION AMPLIFIER**

*For operation in a 525-line, 30-frame system*

**Maximum Ratings:**

|  |                  |                |
|--|------------------|----------------|
| DC PLATE VOLTAGE.....                        | 700 <i>max</i>   | volts          |
| PEAK POSITIVE PULSE PLATE VOLTAGE*.....      | 6600 <i>max</i>  | volts          |
| PEAK NEGATIVE PULSE PLATE VOLTAGE*.....      | -1500 <i>max</i> | volts          |
| DC GRID-NO.2 (SCREEN) VOLTAGE†.....          | 350 <i>max</i>   | volts          |
| PEAK NEGATIVE PULSE GRID-NO.1 VOLTAGE*.....  | -300 <i>max</i>  | volts          |
| <b>CATHODE CURRENT:</b>                      |                  |                |
| Peak.....                                    | 400 <i>max</i>   | ma             |
| DC.....                                      | 110 <i>max</i>   | ma             |
| PLATE DISSIPATION‡.....                      | 20 <i>max</i>    | watts          |
| GRID-NO.2 INPUT.....                         | 3.2 <i>max</i>   | watts          |
| <b>PEAK HEATER-CATHODE VOLTAGE:</b>          |                  |                |
| Heater negative with respect to cathode..... | 200 <i>max</i>   | volts          |
| Heater positive with respect to cathode..... | 200 <i>max</i>   | volts          |
| BULB TEMPERATURE (At hottest point).....     | 210 <i>max</i>   | <sup>o</sup> C |

**Maximum Circuit Value:**

|                                   |                 |        |
|-----------------------------------|-----------------|--------|
| Grid-No.1-Circuit Resistance..... | 0.47 <i>max</i> | megohm |
|-----------------------------------|-----------------|--------|

\* The duration of the voltage pulse must not exceed 15% of one horizontal scanning cycle. In a 525-line, 30-frame system, 15% of one horizontal scanning cycle is 10 microseconds.

† Preferably obtained through a series dropping resistor of sufficient magnitude to limit the grid-No.2 input to the rated maximum value.

‡ An adequate bias resistor or other means is required to protect the tube in the absence of excitation.

■ The dc component must not exceed 100 volts.

AVERAGE PLATE CHARACTERISTICS  
WITH  $E_{C2}$  AS VARIABLE

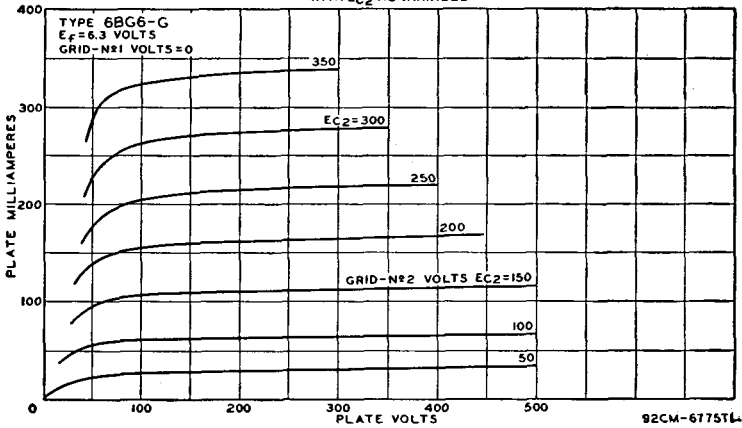

## SHARP-CUTOFF PENTODE

Miniature type used as rf amplifier particularly in ac/dc receivers and in mobile equipment where low heater-current drain is important. It is particularly useful in high-frequency, wide-band applications. Outline 13, OUTLINES SECTION. Tube requires miniature seven-contact socket and may be mounted in any position. For heater and cathode considerations, refer to type 6AV6.

# 6BH6

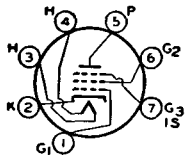

requires miniature seven-contact socket and may be mounted in any position. For heater and cathode considerations, refer to type 6AV6.

|  |            |               |
|--|------------|---------------|
| HEATER VOLTAGE (AC/DC).....  | 6.3        | volts         |
| HEATER CURRENT.....  | 0.15       | ampere        |
| <b>DIRECT INTERELECTRODE CAPACITANCES:</b>                                   |            |               |
| Grid No.1 to Plate.....  | 0.0035 max | $\mu\text{f}$ |
| Grid No.1 to Cathode, Heater, Grid No.2, Grid No.3, and Internal Shield..... | 5.4        | $\mu\text{f}$ |
| Plate to Cathode, Heater, Grid No.2, Grid No.3, and Internal Shield....      | 4.4        | $\mu\text{f}$ |

|   |           |                                      |  |
|---|-----------|--------------------------------------|--|
| <b>Maximum Ratings:</b>                               |           | <b>CLASS A<sub>1</sub> AMPLIFIER</b> |  |
| PLATE VOLTAGE.....                                    | 300 max   | volts                                |  |
| GRID-NO.2 (SCREEN) VOLTAGE.....                       | See curve | page 64                              |  |
| GRID-NO.2 SUPPLY VOLTAGE.....                         | 300 max   | volts                                |  |
| PLATE DISSIPATION.....                                | 3 max     | watts                                |  |
| <b>GRID-NO.2 INPUT:</b>                               |           |                                      |  |
| For grid-No.2 voltages up to 150 volts.....           | 0.5 max   | watt                                 |  |
| For grid-No.2 voltages between 150 and 300 volts..... | See curve | page 64                              |  |
| <b>GRID-NO.1 (CONTROL-GRID) VOLTAGE:</b>              |           |                                      |  |
| Negative bias value.....                              | 50 max    | volts                                |  |
| Positive bias value.....                              | 0 max     | volts                                |  |
| <b>PEAK HEATER-CATHODE VOLTAGE:</b>                   |           |                                      |  |
| Heater negative with respect to cathode.....          | 90 max    | volts                                |  |
| Heater positive with respect to cathode.....          | 90 max    | volts                                |  |

|  |                                |      |                  |
|--|--------------------------------|------|------------------|
| <b>Typical Operation and Characteristics:</b>              |                                |      |                  |
| Plate Voltage.....   | 100                            | 250  | volts            |
| Grid-No.3 (Suppressor).....                                | Connected to cathode at socket |      |                  |
| Grid-No.2 Voltage.....                                     | 100                            | 150  | volts            |
| Grid-No.1 Voltage.....                                     | -1                             | -1   | volt             |
| Plate Resistance (Approx.).....                            | 0.7                            | 1.4  | megohms          |
| Transconductance.....                                      | 3400                           | 4600 | $\mu\text{mhos}$ |
| Grid-No.1 Bias for plate current of 10 $\mu\text{a}$ ..... | -5                             | -7.7 | volts            |
| Plate Current.....   | 3.6                            | 7.4  | ma               |
| Grid-No.2 Current.....                                     | 1.4                            | 2.9  | ma               |

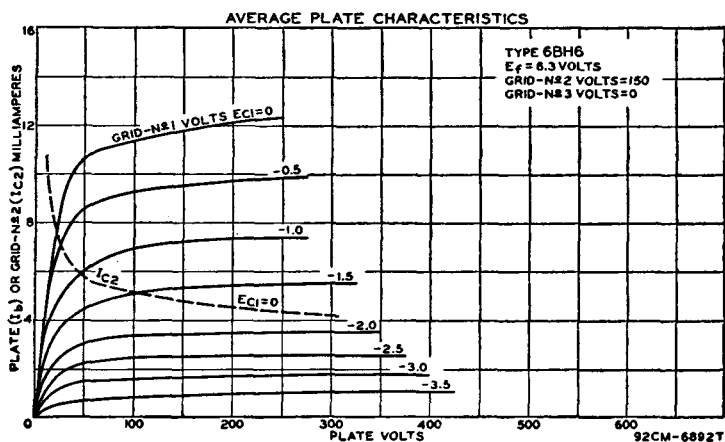

## 6BJ6

### REMOTE-CUTOFF PENTODE

Miniature type used as rf amplifier in high-frequency and wide-band applications. Features high transconductance and low grid-to-plate capacitance. Outline 13, OUTLINES SECTION.

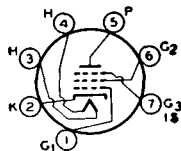

Tube requires miniature seven-contact socket and may be mounted in any position. For heater and cathode considerations, refer to type 6AV6.

|   |            |               |
|---|------------|---------------|
| HEATER VOLTAGE (AC/DC) .....  | 6.3        | volts         |
| HEATER CURRENT .....  | 0.15       | ampere        |
| <b>DIRECT INTERELECTRODE CAPACITANCES:</b>                                      |            |               |
| Grid No.1 to Plate .....  | 0.0035 max | $\mu\text{f}$ |
| Grid No.1 to Cathode, Heater, Grid No. 2, Grid No. 3, and Internal Shield ..... | 4.5        | $\mu\text{f}$ |
| Plate to Cathode, Heater, Grid No. 2, Grid No. 3, and Internal Shield .....     | 5.5        | $\mu\text{f}$ |

### CLASS A<sub>1</sub> AMPLIFIER

#### Maximum Ratings:

|  |                   |       |
|--|-------------------|-------|
| PLATE VOLTAGE .....                                    | 300 max           | volts |
| GRID NO.2 (SCREEN) VOLTAGE .....                       | See curve page 64 |       |
| GRID-NO.2 SUPPLY VOLTAGE .....                         | 300 max           | volts |
| PLATE DISSIPATION .....                                | 3 max             | watts |
| <b>GRID-NO.2 INPUT:</b>                                |                   |       |
| For grid-No.2 voltages up to 150 volts .....           | 0.6 max           | watt  |
| For grid-No.2 voltages between 150 and 300 volts ..... | See curve page 64 |       |
| <b>GRID-NO.1 (CONTROL-GRID) VOLTAGE:</b>               |                   |       |
| Negative bias value .....                              | 50 max            | volts |
| Positive bias value .....                              | 0 max             | volts |
| <b>PEAK HEATER-CATHODE VOLTAGE:</b>                    |                   |       |
| Heater negative with respect to cathode .....          | 90 max            | volts |
| Heater positive with respect to cathode .....          | 90 max            | volts |

#### Typical Operation:

|  |                                |      |                  |
|--|--------------------------------|------|------------------|
| Plate Voltage .....  | 100                            | 250  | volts            |
| Grid No.3 (Suppressor) .....   | Connected to cathode at socket |      |                  |
| Grid-No.2 Voltage .....  | 100                            | 100  | volts            |
| Grid-No.1 Voltage .....  | -1.0                           | -1.0 | volt             |
| Plate Resistance (Approx.) .....   | 0.25                           | 1.3  | megohms          |
| Transconductance .....   | 3650                           | 3600 | $\mu\text{mhos}$ |
| Grid-No.1 Bias (Approx.) for transconductance of 15 $\mu\text{mhos}$ ..... | -20                            | -20  | volts            |
| Plate Current .....  | 9.0                            | 9.2  | ma               |
| Grid-No.2 Current .....  | 3.5                            | 3.3  | ma               |

## AVERAGE PLATE CHARACTERISTICS PENTODE CONNECTION

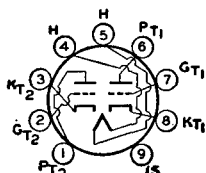
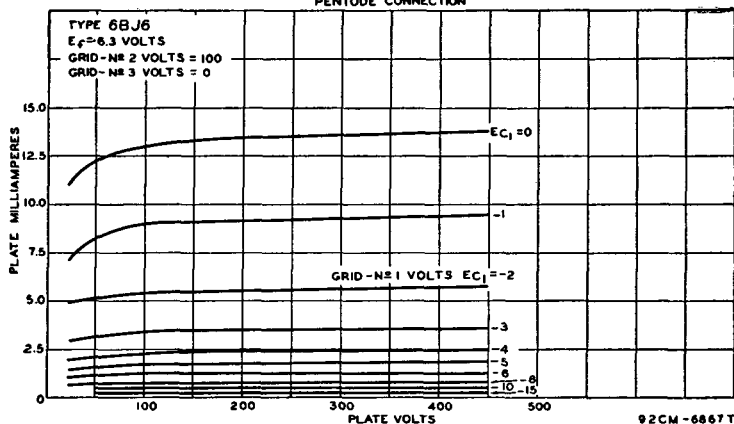

### MEDIUM-MU TWIN TRIODE

Miniature type used as rf amplifier in tuners of vhf television receivers or as low-noise if preamplifier tube in uhf television receivers employing a crystal mixer. Especially useful in the

rf stage of television receivers utilizing a cathode-drive amplifier of the direct-coupled type or in push-pull cathode-drive rf amplifiers. Outline 14, OUTLINES SECTION. Tube requires noval nine-contact socket and may be mounted in any position.

## 6BK7-A

|                              |      |        |
|------------------------------|------|--------|
| HEATER VOLTAGE (AC/DC) ..... | 6.3  | volts  |
| HEATER CURRENT .....         | 0.45 | ampere |

#### DIRECT INTERELECTRODE CAPACITANCES:

|   | Unit No.1 | Unit No.2 |               |
|---|-----------|-----------|---------------|
| Grid to Plate .....                                 | 1.8       | 1.8       | $\mu\text{f}$ |
| Grid to Cathode, Heater, and Internal Shield .....  | 3.0       | 3.0       | $\mu\text{f}$ |
| Cathode to Grid, Heater, and Internal Shield .....  | 6.0       | 6.0       | $\mu\text{f}$ |
| Plate to Cathode, Heater, and Internal Shield ..... | 1.0       | 0.9       | $\mu\text{f}$ |
| Plate to Grid, Heater, and Internal Shield .....    | 2.4       | 2.4       | $\mu\text{f}$ |
| Plate to Cathode .....                              | 0.22      | 0.22      | $\mu\text{f}$ |
| Heater to Cathode .....                             | 2.8       | 3.0       | $\mu\text{f}$ |
| Grid of Unit No.1 to Grid of Unit No.2 .....        | 0.004 max |           | $\mu\text{f}$ |
| Plate of Unit No.1 to Plate of Unit No.2 .....      | 0.075 max |           | $\mu\text{f}$ |

### CLASS A<sub>1</sub> AMPLIFIER (Each Unit)

#### Maximum Ratings:

|   |         |       |
|---|---------|-------|
| PLATE VOLTAGE .....                           | 300 max | volts |
| DC GRID VOLTAGE:                              |         |       |
| Negative bias value .....                     | 50 max  | volts |
| PLATE DISSIPATION .....                       | 2.7 max | watts |
| PEAK HEATER-CATHODE VOLTAGE:                  |         |       |
| Heater negative with respect to cathode ..... | 90*max  | volts |
| Heater positive with respect to cathode ..... | 90 max  | volts |

\* In cathode-drive circuits with direct-coupled drive, it is permissible for this voltage to be as high as 250 volts.

#### Characteristics:

|   |      |                  |
|---|------|------------------|
| Plate Voltage .....   | 150  | volts            |
| Cathode-Bias Resistor .....                                     | 56   | ohms             |
| Amplification Factor .....                                      | 43   |                  |
| Plate Resistance (Approx.) .....                                | 4600 | ohms             |
| Transconductance .....  | 9300 | $\mu\text{mhos}$ |
| Plate Current .....   | 18   | ma               |
| Grid Bias (Approx.) for plate current of 10 $\mu\text{a}$ ..... | -11  | volts            |

# 6BL7-GT

## MEDIUM-MU TWIN TRIODE

Glass octal type used as a combined vertical deflection amplifier and vertical oscillator in television receivers. Outline 22, OUTLINES SECTION. Tube requires octal socket and may be mounted in any position.

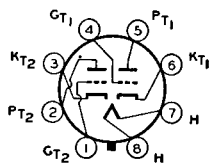

|                             |     |         |
|-----------------------------|-----|---------|
| HEATER VOLTAGE (AC/DC)..... | 6.3 | volts   |
| HEATER CURRENT.....         | 1.5 | amperes |

|  |      |       |
|--|------|-------|
| <b>CLASS A<sub>1</sub> AMPLIFIER (Each Unit)</b>                                   |      |       |
| Plate Voltage.....   | 250  | volts |
| Grid Voltage.....  | -9   | volts |
| Amplification Factor.....  | 15   |       |
| Plate Resistance.....  | 2150 | ohms  |
| Transconductance.....  | 6200 | μmhos |
| Grid Bias (Approx.) for plate current of 25 μa.....                                | -25  | volts |
| Plate Current.....   | 40   | ma    |
| Grid Bias (Approx.) for plate voltage of 600 volts and plate current of 50 μa..... | -60  | volts |

### VERTICAL DEFLECTION AMPLIFIER (Each Unit)

*For operation in a 525-line, 30-frame system*

|  |          |       |
|--|----------|-------|
| <b>Maximum Ratings:</b>                      |          |       |
| DC PLATE VOLTAGE.....                        | 500 max  | volts |
| PEAK POSITIVE-PULSE PLATE VOLTAGE†.....      | 1800 max | volts |
| PEAK NEGATIVE-PULSE GRID VOLTAGE.....        | -500 max | volts |
| DC CATHODE CURRENT.....                      | 60 max   | ma    |
| PLATE DISSIPATION.....                       | 10 max   | watts |
| (Total for both units).....                  | 12 max   | watts |
| <b>PEAK HEATER-CATHODE VOLTAGE:</b>          |          |       |
| Heater negative with respect to cathode..... | 200 max  | volts |
| Heater positive with respect to cathode..... | 200 max  | volts |

### Maximum Circuit Value:

|   |         |         |
|---|---------|---------|
| Grid-Circuit Resistance:<br>For cathode-bias operation..... | 4.7 max | megohms |
|---|---------|---------|

† The duration of the voltage pulse must not exceed 15 per cent of one vertical scanning cycle. In a 525-line, 30-frame system, 15 per cent of one vertical scanning cycle is 2.5 milliseconds.

## BEAM POWER TUBE

# 6BQ6-GT

Glass octal type used as horizontal deflection amplifier in television receivers employing either transformer coupling or direct coupling to the deflecting yoke. Outline 28, OUTLINES SECTION.

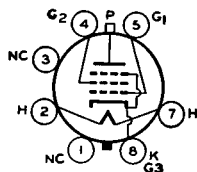

except seated height is 3 to 3-5/16 inches and over-all height is 3 7/8 max inches. Tube requires octal socket and may be mounted in any position. This type may be supplied with pin No.1 omitted.

|   |      |         |
|---|------|---------|
| HEATER VOLTAGE (AC/DC).....                                 | 6.3  | volts   |
| HEATER CURRENT.....   | 1.2  | amperes |
| <b>DIRECT INTERELECTRODE CAPACITANCES (Approx.):</b>        |      |         |
| Grid No.1 to Plate.....                                     | 0.6  | μμf     |
| Grid No.1 to Cathode, Heater, Grid No.2, and Grid No.3..... | 15   | μμf     |
| Plate to Cathode, Heater, Grid No.2, and Grid No.3.....     | 7.5  | μμf     |
| TRANSCONDUCTANCE*.....                                      | 5500 | μmhos   |
| MU-FACTOR, Grid No.2 to Grid No.1**.....                    | 4.3  |         |

\* For plate volts, 250; grid-No.2 volts, 150; grid-No.1 volts, -22.5; plate ma., 55; grid-No.2 ma., 2.1.

\*\* For plate and grid-No.2 volts, 150; grid-No.1 volts, -22.5.

### HORIZONTAL DEFECTION AMPLIFIER

*For operation in a 525-line, 30-frame system*

|  |           |       |
|--|-----------|-------|
| <b>Maximum Ratings:</b>                                    |           |       |
| DC PLATE SUPPLY VOLTAGE (Boost plus dc power supply).....  | 550 max   | volts |
| PEAK POSITIVE-PULSE PLATE VOLTAGE† (Absolute Maximum)..... | 5500 max  | volts |
| PEAK NEGATIVE-PULSE PLATE VOLTAGE†.....                    | -1250 max | volts |
| DC GRID-NO.2 (SCREEN) VOLTAGE.....                         | 175 max   | volts |
| PEAK NEGATIVE-PULSE GRID-NO.1 (CONTROL-GRID) VOLTAGE†..... | -300 max  | volts |



**CATHODE CURRENT:**

|  |                |       |
|--|----------------|-------|
| Peak.....                                    | 400 <i>max</i> | ma    |
| DC.....                                      | 110 <i>max</i> | ma    |
| GRID-NO.2 INPUT.....                         | 2.5 <i>max</i> | watts |
| PLATE DISSIPATION #.....                     | 11 <i>max</i>  | watts |
| <b>PEAK HEATER-CATHODE VOLTAGE:</b>          |                |       |
| Heater negative with respect to cathode..... | 200 <i>max</i> | volts |
| Heater positive with respect to cathode..... | 200 <i>max</i> | volts |
| BULB TEMPERATURE (At hottest point).....     | 220 <i>max</i> | °C    |

**Maximum Circuit Value:**

|                                   |                 |        |
|-----------------------------------|-----------------|--------|
| Grid-No.1-Circuit Resistance..... | 0.47 <i>max</i> | megohm |
|-----------------------------------|-----------------|--------|

† The duration of the voltage pulse must not exceed 15 per cent of one horizontal scanning cycle. In a 525-line, 30-frame system, 15 per cent of one horizontal scanning cycle is 10 microseconds.

° Under no circumstances should this absolute value be exceeded.

# An adequate bias resistor or other means is required to protect the tube in the absence of excitation.

■ The dc component must not exceed 100 volts.

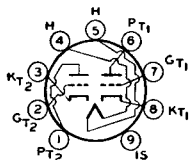
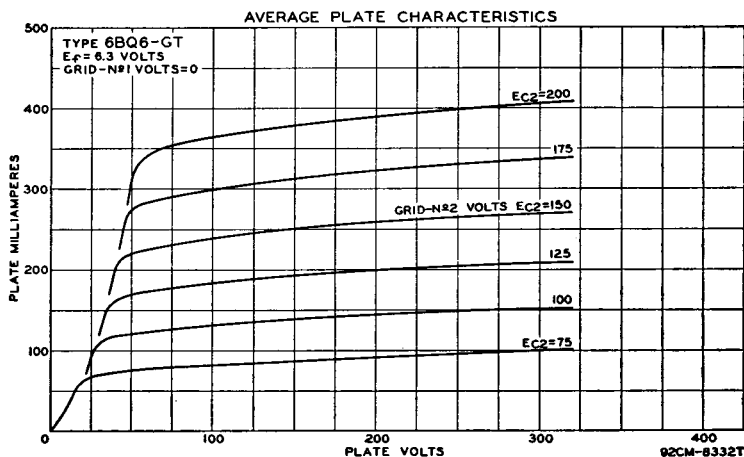

## MEDIUM-MU TWIN TRIODE

# 6BQ7 6BQ7-A

Miniature types used as rf amplifiers in tuners of vhf television receivers or as low-noise if pre-amplifier tubes in uhf television receivers employing a crystal mixer. Both types are especially

useful in the rf stage of television receivers utilizing a cathode-drive amplifier of the direct-coupled type or in push-pull cathode-drive rf amplifiers. Outline 14, OUTLINES SECTION. Tubes require noval nine-contact socket and may be mounted in any position. Type 6BQ7 is a DISCONTINUED type listed for reference only.

|   |                  |                  |
|---|------------------|------------------|
| HEATER VOLTAGE (AC/DC).....                                     | 6.3              | volts            |
| HEATER CURRENT.....   | 0.4              | ampere           |
| <b>DIRECT INTERELECTRODE CAPACITANCES (Approx.)<sup>o</sup></b> |                  |                  |
|   | <i>Unit No.1</i> | <i>Unit No.2</i> |
| Grid to Plate.....  | 1.15             | 1.15             |
| Grid to Cathode, Heater, and Internal Shield....                | 2.85             | -                |
| Cathode to Grid, Heater, and Internal Shield....                | -                | 4.95             |
| Plate to Cathode, Heater, and Internal Shield....               | 1.35             | -                |
| Plate to Grid, Heater, and Internal Shield....                  | -                | 2.27             |
| Plate to Cathode.....   | 0.15 <i>max</i>  | 0.15 <i>max</i>  |
| Heater to Cathode (6BQ7).....                                   | 2.20             | 2.30             |
| Heater to Cathode (6BQ7-A).....                                 | 2.65             | 2.70             |
| Plate of Unit No.1 to Plate of Unit No.2.....                   | 0.010 <i>max</i> |                  |
| Plate of Unit No.2 to Plate and Grid of Unit No.1.....          | 0.024 <i>max</i> |                  |

## CLASS A<sub>1</sub> AMPLIFIER (Each Unit)

### Maximum Ratings:

|   |         |       |
|---|---------|-------|
| PLATE VOLTAGE .....                           | 250*max | volts |
| PLATE DISSIPATION .....                       | 2 max   | watts |
| CATHODE CURRENT .....                         | 20 max  | ma    |
| PEAK HEATER-CATHODE VOLTAGE:                  |         |       |
| Heater negative with respect to cathode ..... | 200*max | volts |
| Heater positive with respect to cathode ..... | 200 max | volts |

### Characteristics:

|  | 6BQ7 | 6BQ7-A |       |
|--|------|--------|-------|
| Plate Voltage .....                                  | 150  | 150    | volts |
| Cathode-Bias Resistor .....                          | 220  | 220    | ohms  |
| Amplification Factor .....                           | 35   | 39     |       |
| Plate Resistance .....                               | 5800 | 6100   | ohms  |
| Transconductance .....                               | 6000 | 6400   | μmhos |
| Plate Current .....                                  | 9    | 9      | ma    |
| Grid Bias (Approx.) for plate current of 10 μa ..... | -10  | -10    | volts |

\* With external shield connected to cathode.

\* In cathode-circuits with direct-coupled drive, it is permissible for this voltage to be as high as 300 volts.

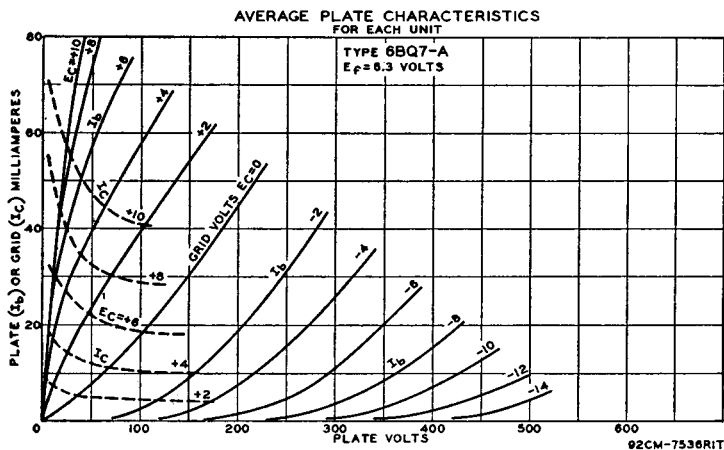

## PENTAGRID AMPLIFIER

# 6BY6

Miniature type used as a gated amplifier in color television receivers. In such service, it may be used as a combined sync separator and sync clipper. Outline 13, OUTLINES SEC-

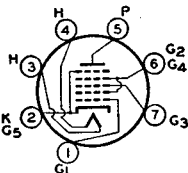

TION. Tube requires miniature seven-contact socket and may be mounted in any position.

|   |          |        |
|---|----------|--------|
| HEATER VOLTAGE (AC/DC) .....            | 6.3      | volts  |
| HEATER CURRENT .....                    | 0.3      | ampere |
| DIRECT INTERELECTRODE CAPACITANCES:     |          |        |
| Grid No.1 to Plate .....                | 0.08 max | μμf    |
| Grid No.3 to Plate .....                | 0.35 max | μμf    |
| Grid No.1 to Grid No.3 .....            | 0.15 max | μμf    |
| Grid No.1 to All Other Electrodes ..... | 5.4      | μμf    |
| Grid No.3 to All Other Electrodes ..... | 6.9      | μμf    |
| Plate to All Other Electrodes .....     | 7.6      | μμf    |

### Characteristics:

## CLASS A<sub>1</sub> AMPLIFIER

|   |      |       |
|---|------|-------|
| Plate Voltage .....                       | 250  | volts |
| Grids-No.2-and-No.4 Voltage .....         | 100  | volts |
| Grid-No.3 Voltage .....                   | -2.5 | volts |
| Grid-No.1 Voltage .....                   | -2.5 | volts |
| Grid-No.3-to-Plate Transconductance ..... | 500  | μmhos |
| Grid-No.1-to-Plate Transconductance ..... | 1900 | μmhos |

# RCA Receiving Tube Manual

|   |     |       |
|---|-----|-------|
| Plate Current.....  | 6.5 | ma    |
| Grids-No.2-and-No.4 Current.....  | 9   | ma    |
| Grid-No.3 Volts (Approx.) for plate current of 35 $\mu$ a and grid-No.1 volts = -4  | -15 | volts |
| Grid-No.1 Volts (Approx.) for plate current of 35 $\mu$ a and grid-No.3 volts = 0.. | -12 | volts |

## GATED AMPLIFIER SERVICE

### Maximum Ratings:

|   |                   |       |
|---|-------------------|-------|
| PLATE VOLTAGE.....  | 300 max           | volts |
| GRIDS-NO.2-AND-NO.4 VOLTAGE.....                                | See curve page 64 |       |
| GRIDS-NO.2-AND-NO.4 SUPPLY VOLTAGE.....                         | 300 max           | volts |
| GRID-NO.3 SUPPLY VOLTAGE:                                       |                   |       |
| Negative bias value.....  | 50 max            | volts |
| Positive bias value.....  | 0 max             | volts |
| Positive peak value.....  | 25 max            | volts |
| GRID-NO.1 SUPPLY VOLTAGE:                                       |                   |       |
| Negative bias value.....  | 100 max           | volts |
| PLATE DISSIPATION.....  | 2 max             | watts |
| GRID-NO.3 INPUT.....  | 0.1 max           | watt  |
| GRIDS-NO.2-AND-NO.4 INPUT:                                      |                   |       |
| For grids-No.2-and-No.4 voltages up to 150 volts.....           | 1 max             | watt  |
| For grids-No.2-and-No.4 voltages between 150 and 300 volts..... | See curve page 64 |       |
| GRID-NO.1 INPUT.....  | 0.1 max           | watt  |
| PEAK HEATER-CATHODE VOLTAGE:                                    |                   |       |
| Heater negative with respect to cathode.....                    | 200 max           | volts |
| Heater positive with respect to cathode.....                    | 200°max           | volts |

### Characteristics as Sync Separator and Sync Clipper:

|   |      |       |
|---|------|-------|
| Plate Voltage.....  | 10   | volts |
| Grid-No.3 Voltage.....  | 0    | volts |
| Grids-No.2-and-No.4 Voltage.....  | 25   | volts |
| Grid-No.1 Voltage.....  | 0    | volts |
| Plate Current.....  | 1.4  | ma    |
| Grids-No.2-and-No.4 Current.....  | 3.5  | ma    |
| Grid-No.3 Volts (Approx.) for plate voltage of 25 volts, grids-No.2-and-No.4 voltage of 25 volts, grid-No.1 voltage of 0 volts, and plate current of 50 $\mu$ a | -2.5 | volts |
| Grid-No.1 Volts (Approx.) for plate voltage of 25 volts, grids-No.2-and-No.4 voltage of 25 volts, grid-No.3 voltage of 0 volts, and plate current of 50 $\mu$ a | -2.3 | volts |

### Maximum Circuit Values:

#### Grid-No.1 or Grid-No.3-Circuit Resistance:

|                                 |         |        |
|---------------------------------|---------|--------|
| For fixed-bias operation.....   | 0.5 max | megohm |
| For cathode-bias operation..... | 1.0 max | megohm |

° The dc component must not exceed 100 volts.

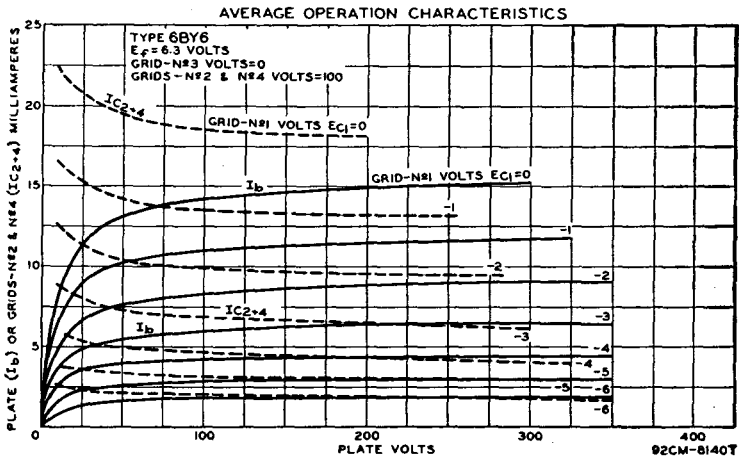

## AVERAGE OPERATION CHARACTERISTICS

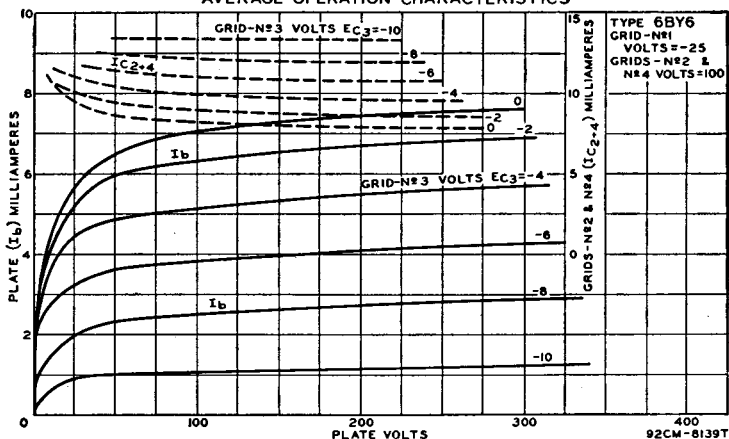

## MEDIUM-MU TWIN TRIODE

# 6BZ7

Miniature type used as rf amplifier in tuners of vhf television receivers or as low-noise if pre-amplifier tube in uhf television receivers employing a crystal mixer. Especially useful in the

rf stage of television receivers utilizing a cathode-drive amplifier of the direct-coupled type or in push-pull cathode-drive rf amplifiers. Outline 14, OUTLINES SECTION. Tube requires noval nine-contact socket and may be mounted in any position.

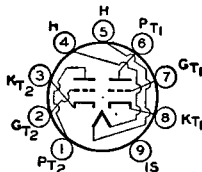

|   |                  |                  |
|---|------------------|------------------|
| HEATER VOLTAGE (AC/DC) .....                            | 6.3              | volts            |
| HEATER CURRENT .....                                    | 0.4              | ampere           |
| DIRECT INTERELECTRODE CAPACITANCES: <sup>o</sup>        |                  |                  |
|   | <i>Unit No.1</i> | <i>Unit No.2</i> |
| Grid to Plate .....                                     | 1.15             | $\mu\mu\text{f}$ |
| Grid to Cathode, Heater, and Internal Shield ..         | 2.50             | $\mu\mu\text{f}$ |
| Cathode to Grid, Heater, and Internal Shield ..         | —                | $\mu\mu\text{f}$ |
| Plate to Cathode, Heater, and Internal Shield ..        | 1.35             | $\mu\mu\text{f}$ |
| Cathode to Plate, Heater, and Internal Shield ..        | —                | $\mu\mu\text{f}$ |
| Plate to Cathode .....                                  | 0.15 <i>max</i>  | $\mu\mu\text{f}$ |
| Heater to Cathode .....                                 | 2.6              | $\mu\mu\text{f}$ |
| Plate of Unit No.1 to Plate of Unit No.2 .....          | 0.010 <i>max</i> | $\mu\mu\text{f}$ |
| Plate of Unit No.2 to Plate and Grid of Unit No.2 ..... | 0.024 <i>max</i> | $\mu\mu\text{f}$ |

<sup>o</sup> With external shield tied to cathode.

### Maximum Ratings:

### CLASS A<sub>1</sub> AMPLIFIER (Each Unit)

|   |                 |       |
|---|-----------------|-------|
| PLATE VOLTAGE .....                           | 250* <i>max</i> | volts |
| PLATE DISSIPATION .....                       | 2.0 <i>max</i>  | watts |
| CATHODE CURRENT .....                         | 20 <i>max</i>   | ma    |
| PEAK HEATER-CATHODE VOLTAGE:                  |                 |       |
| Heater negative with respect to cathode ..... | 200* <i>max</i> | volts |
| Heater positive with respect to cathode ..... | 200 <i>max</i>  | volts |

\* In cathode-drive circuits with direct-coupled drive, it is permissible for this voltage to be as high as 300 volts.

### Characteristics:

|   |      |                  |
|---|------|------------------|
| Plate Voltage .....   | 150  | volts            |
| Cathode-Bias Resistor .....                                     | 220  | ohms             |
| Amplification Factor .....                                      | 38   |                  |
| Plate Resistance (Approx.) .....                                | 5600 | ohms             |
| Transconductance .....  | 6800 | $\mu\text{mhos}$ |
| Plate Current .....   | 10   | ma               |
| Grid Bias (Approx.) for plate current of 10 $\mu\text{a}$ ..... | -11  | volts            |

### Maximum Circuit Value:

|                               |                |        |
|-------------------------------|----------------|--------|
| Grid-Circuit Resistance ..... | 0.5 <i>max</i> | megohm |
|-------------------------------|----------------|--------|

HF TRIODE

6C4

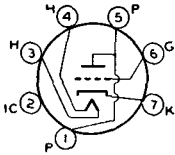

Miniature type used in compact radio equipment as a local oscillator in FM and other high-frequency circuits. It may also be used as a class C rf amplifier. In such service, it delivers

a power output of 5.5 watts at moderate frequencies, and 2.5 watts at 150 megacycles per second. Outline 13, **OUTLINES SECTION**. Tube requires miniature seven-contact socket and may be mounted in any position. For typical operation as a resistance-coupled amplifier, refer to Chart 10, **RESISTANCE-COUPLED AMPLIFIER SECTION**. For heater and cathode considerations, refer to type 6AV6. For additional curve of plate characteristics, refer to type 12AU7.

|   |          |               |                  |
|---|----------|---------------|------------------|
| HEATER VOLTAGE (AC/DC)                        | 6.3      | volts         |                  |
| HEATER CURRENT                                | 0.15     | ampere        |                  |
| <b>DIRECT INTERELECTRODE CAPACITANCES:</b>    |          |               |                  |
| Grid to Plate                                 | 1.6      | $\mu\text{f}$ |                  |
| Grid to Cathode and Heater                    | 1.8      | $\mu\text{f}$ |                  |
| Plate to Cathode and Heater                   | 1.3      | $\mu\text{f}$ |                  |
| <b>Maximum Ratings:</b>                       |          |               |                  |
| PLATE VOLTAGE                                 | 300 max  | volts         |                  |
| PLATE DISSIPATION                             | 3.5 max  | watts         |                  |
| PEAK HEATER-CATHODE VOLTAGE:                  |          |               |                  |
| Heater negative with respect to cathode       | 200 max  | volts         |                  |
| Heater positive with respect to cathode       | 200 max  | volts         |                  |
| <b>Characteristics:</b>                       |          |               |                  |
| Plate Voltage                                 | 100      | 250           | volts            |
| Grid Voltage                                  | 0        | -8.5          | volts            |
| Amplification Factor                          | 19.5     | 17            |                  |
| Plate Resistance                              | 6250     | 7700          | ohms             |
| Transconductance                              | 3100     | 2200          | $\mu\text{mhos}$ |
| Plate Current                                 | 11.8     | 10.5          | ma               |
| <b>Maximum Circuit Value:</b>                 |          |               |                  |
| Grid-Circuit Resistance:                      |          |               |                  |
| For fixed-bias operation                      | 0.25 max | megohm        |                  |
| For cathode-bias operation                    | 1.0 max  | megohm        |                  |
| ■ The dc component must not exceed 100 volts. |          |               |                  |

CLASS A<sub>1</sub> AMPLIFIER

RF POWER AMPLIFIER AND OSCILLATOR—Class C Telegraphy

|   |         |       |
|---|---------|-------|
| <b>Maximum Ratings:</b>                             |         |       |
| DC PLATE VOLTAGE                                    | 300 max | volts |
| DC GRID VOLTAGE                                     | -50 max | volts |
| DC PLATE CURRENT                                    | 25 max  | ma    |
| DC GRID CURRENT                                     | 8 max   | ma    |
| PLATE DISSIPATION                                   | 5 max   | watts |
| <b>Typical Operation (At Moderate Frequencies):</b> |         |       |
| DC Plate Voltage                                    | 300     | volts |
| DC Grid Voltage                                     | -27     | volts |
| DC Plate Current                                    | 25      | ma    |
| DC Grid Current (Approx.)                           | 7       | ma    |
| Driving Power (Approx.)                             | 0.35    | watt  |
| Power Output (Approx.)                              | 5.5     | watts |

AVERAGE PLATE CHARACTERISTICS

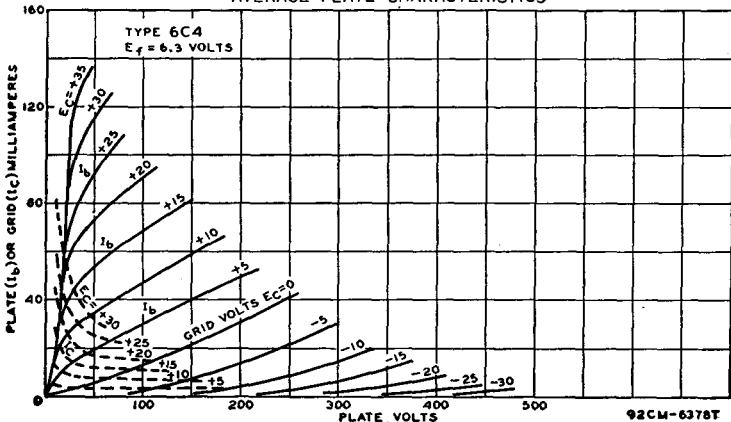

**MEDIUM-MU TRIODE**

**6C5  
6C5-GT**

Metal type 6C5 and glass-octal type 6C5-GT used as audio amplifier and oscillator. They are also used as detectors of grid-resistor-and-capacitor type or grid-bias type. Outlines 3 and 25, respectively, OUTLINES SECTION. Tubes require octal socket and may be mounted in any position. Heater volts (ac/dc), 6.3; amperes, 0.3. Maximum ratings as class A<sub>1</sub> amplifier:

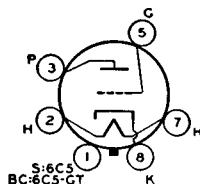
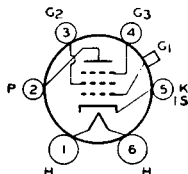

plate volts, 300 *max*; plate dissipation, 2.5 *max* watts; grid volts, 0 *min*. Typical operation: plate volts, 250; grid volts, -8 (grid-circuit resistance should not exceed 1.0 megohm); amplification factor, 20; plate resistance, 10000 ohms; transconductance, 2000  $\mu$ mhos; plate ma., 8. For typical operation as a resistance-coupled amplifier, refer to Chart 11, RESISTANCE-COUPLED AMPLIFIER SECTION. Type 6C5-GT is used principally for renewal purposes.

**SHARP-CUTOFF PENTODE**

**6C6**

Glass type used as biased detector and as a high-gain amplifier in radio equipment. Outline 40, OUTLINES SECTION. Tube requires six-contact socket. Heater volts (ac/dc), 6.3; amperes, 0.3. For ratings and typical operation data, refer to type 6J7. Type 6C6 is used principally for renewal purposes.



**TWIN DIODE—  
MEDIUM-MU TRIODE**

**6C7**

Glass type used as combined detector, amplifier, and avc tube. Outline 36, OUTLINES SECTION. Heater volts (ac/dc), 6.3; amperes, 0.3. This type is similar to, but not interchangeable with, type 85. The 6C7 is a DISCONTINUED type listed for reference only.

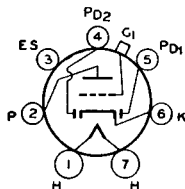

**MEDIUM-MU TWIN TRIODE**

**6C8-G**

Glass octal type used as a voltage amplifier and phase inverter in radio equipment. Outline 35, OUTLINES SECTION. When this type is used in a high-gain amplifier, hum may be reduced or eliminated by grounding pin No.7 or by grounding the arm of a 100-to-500-ohm potentiometer across the heater terminals. Tube requires octal socket. Heater volts (ac/dc), 6.3;

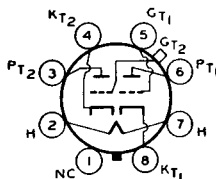

amperes, 0.3. Maximum ratings for each triode unit as class A<sub>1</sub> amplifier: plate volts, 250 *max*; grid volts, 0 *min*; plate dissipation, 1.0 *max* watt. Typical operation: plate volts, 250; grid volts, -4.5; plate ma., 3.2; plate resistance, 22500 ohms; amplification factor, 36; transconductance, 1600  $\mu$ mhos. For typical operation as a resistance-coupled amplifier, refer to Chart 12, RESISTANCE-COUPLED AMPLIFIER SECTION. This type is used principally for renewal purposes.

**SHARP-CUTOFF PENTODE**

**6CB6**

Miniature type used in television receivers as an intermediate-frequency amplifier at frequencies up to about 45 megacycles per second and as an rf amplifier in vhf television tuners. Tube

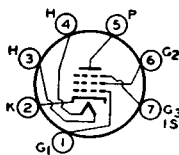

features very high transconductance combined with low interelectrode capacitance values, and is provided with separate base pins for grid No.3 and the cathode to permit the use of an unbypassed cathode resistor to minimize the effects of regeneration. Outline 13, OUTLINES SECTION. Tube requires miniature seven-contact socket and may be mounted in any position. For heater and cathode considerations, refer to type 6AV6.

# RCA Receiving Tube Manual

|   |           |               |
|---|-----------|---------------|
| HEATER VOLTS (AC/DC) .....  | 6.3       | volts         |
| HEATER CURRENT .....  | 0.3       | ampere        |
| DIRECT INTERELECTRODE CAPACITANCES:   |           |               |
| Grid No.1 to Plate .....  | 0.020 max | $\mu\text{f}$ |
| Grid No.1 to Cathode, Heater, Grid No.2, Grid No.3, and Internal Shield ..... | 6.3       | $\mu\text{f}$ |
| Plate to Cathode, Heater, Grid No.2, Grid No.3, and Internal Shield .....     | 1.9       | $\mu\text{f}$ |

### Maximum Ratings:

### CLASS A<sub>1</sub> AMPLIFIER

|  |                   |       |
|--|-------------------|-------|
| PLATE VOLTAGE .....                                    | 300 max           | volts |
| GRID-NO.2 (SCREEN) VOLTAGE .....                       | See curve page 64 |       |
| GRID-NO.2 SUPPLY VOLTAGE .....                         | 300 max           | volts |
| PLATE DISSIPATION .....                                | 2.0 max           | watts |
| GRID-NO.2 INPUT:                                       |                   |       |
| For grid-No.2 voltages up to 150 volts .....           | 0.5 max           | watt  |
| For grid-No.2 voltages between 150 and 300 volts ..... | See curve page 64 |       |
| PEAK HEATER-CATHODE VOLTAGE:                           |                   |       |
| Heater negative with respect to cathode .....          | 90 max            | volts |
| Heater positive with respect to cathode .....          | 90 max            | volts |

### Typical Operation and Characteristics:

|  |                                |                  |
|--|--------------------------------|------------------|
| Plate Voltage .....  | 200                            | volts            |
| Grid-No.3 (Suppressor) .....   | Connected to cathode at socket |                  |
| Grid-No.2 Voltage .....  | 150                            | volts            |
| Cathode-Bias Resistor .....  | 180                            | ohms             |
| Plate Resistance (Approx.) .....                                     | 0.6                            | megohm           |
| Transconductance .....   | 6200                           | $\mu\text{mhos}$ |
| Grid-No.1 Bias (Approx.) for plate current of 10 $\mu\text{a}$ ..... | -8                             | volts            |
| Plate Current .....  | 9.5                            | ma               |
| Grid-No.2 Current .....  | 2.8                            | ma               |

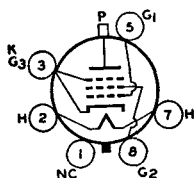
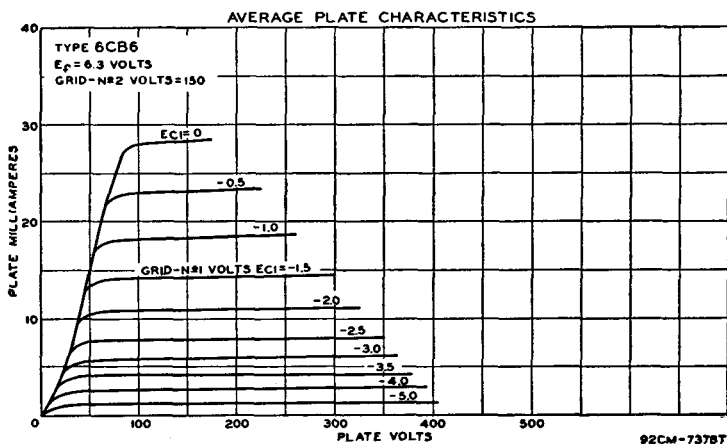

### BEAM POWER TUBE

Glass octal type used as horizontal deflection amplifier in high-efficiency deflection circuits of television receivers employing either transformer coupling or direct coupling to the deflection yoke. Outline 44, OUTLINES SECTION.

## 6CD6-G

Tube requires octal socket. Vertical tube mounting is preferred but horizontal operation is permissible if pins No.2 and 7 are in vertical plane.

|  |         |                  |
|--|---------|------------------|
| HEATER VOLTAGE (AC/DC) .....                                 | 6.3     | volts            |
| HEATER CURRENT .....   | 2.5     | amperes          |
| DIRECT INTERELECTRODE CAPACITANCES:                          |         |                  |
| Grid No.1 to Plate .....                                     | 1.0 max | $\mu\text{f}$    |
| Grid No.1 to Cathode, Heater, Grid No.2, and Grid No.3 ..... | 26      | $\mu\text{f}$    |
| Plate to Cathode, Heater, Grid No.2, and Grid No.3 .....     | 10      | $\mu\text{f}$    |
| TRANSCONDUCTANCE <sup>†</sup> .....                          | 7500    | $\mu\text{mhos}$ |
| MU-FACTOR, Grid No.2 to Grid No.1 <sup>o</sup> .....         | 3.8     |                  |

<sup>o</sup> For plate and grid-No.2 volts, 175; grid-No.1 volts, -30.

## HORIZONTAL DEFLECTION AMPLIFIER

*For operation in a 525-line, 30-frame system*

### Maximum Ratings:

|  |           |       |
|--|-----------|-------|
| DC PLATE VOLTAGE.....                        | 700 maz   | volts |
| PEAK POSITIVE-PULSE PLATE VOLTAGE*.....      | 6000 maz  | volts |
| PEAK NEGATIVE-PULSE PLATE VOLTAGE*.....      | -1500 maz | volts |
| DC GRID-NO.2 (SCREEN) VOLTAGE.....           | 200 maz   | volts |
| DC GRID-NO.1 (CONTROL-GRID) VOLTAGE.....     | -50 maz   | volts |
| PEAK NEGATIVE-PULSE GRID-NO.1 VOLTAGE*.....  | -150 maz  | volts |
| DC PLATE CURRENT.....                        | 170 maz   | ma    |
| PLATE DISSIPATION†.....                      | 15 maz    | watts |
| GRID-NO.2 INPUT.....                         | 8 maz     | watts |
| PEAK HEATER-CATHODE VOLTAGE:                 |           |       |
| Heater negative with respect to cathode..... | 135 maz   | volts |
| Heater positive with respect to cathode..... | 135 maz   | volts |
| BULB TEMPERATURE (At hottest point).....     | 210 maz   | °C    |

### Maximum Circuit Value:

Grid-No.1-Circuit Resistance..... 1.0 maz megohm

\* The duration of the voltage pulse must not exceed 15% of one horizontal scanning cycle. In a 525-line, 30-frame system, 15% of one horizontal scanning cycle is 10 microseconds.

† An adequate bias resistor or other means is required to protect the tube in the absence of excitation.

AVERAGE PLATE CHARACTERISTICS

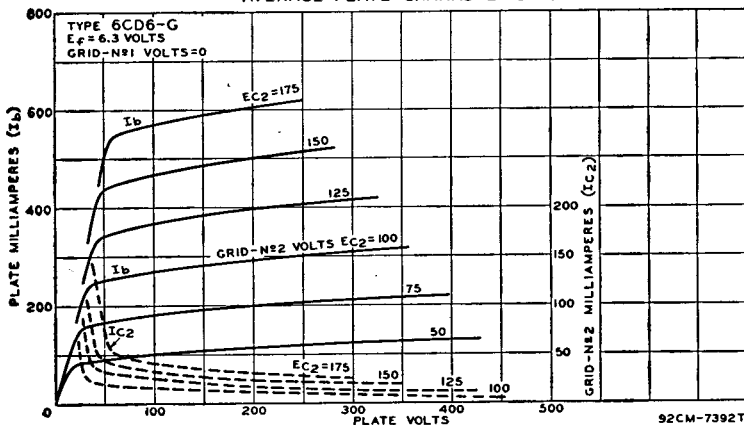

## 6CF6

### SHARP-CUTOFF PENTODE

Miniature type used in television receivers as an intermediate-frequency amplifier at frequencies up to about 45 megacycles per second and as an rf amplifier in vhf television tuners. Be-

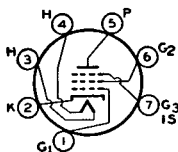

cause of its plate-current cutoff characteristic, this type is used in gain-controlled stages of video if amplifiers. This type is identical with miniature type 6CB6 except that the grid-No.1 bias (approx.) for plate current of 35 microamperes is -6.5 volts. Outline 13, OUTLINES SECTION. Heater volts (ac/dc), 6.3; amperes, 0.3.

## 6CL6

### POWER PENTODE

Miniature type used in output stage of video amplifier of television receivers and as wide-band amplifier tube in industrial and laboratory equipment. Outline 17, OUTLINES SEC-

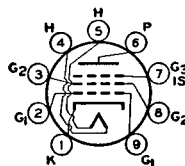

TION. Tube requires noval nine-contact socket. Vertical tube mounting is preferred but horizontal mounting is permissible if pins No.3 and No.8 are in vertical plane.



# RCA Receiving Tube Manual

|   |      |               |
|---|------|---------------|
| HEATER VOLTAGE (AC/DC) .....  | 6.3  | volts         |
| HEATER CURRENT .....  | 0.65 | ampere        |
| DIRECT INTERELECTRODE CAPACITANCES:   |      |               |
| Grid No.1 to Plate .....  | 0.12 | $\mu\text{f}$ |
| Grid No.1 to Cathode, Heater, Grid No.2, Grid No.3, and Internal Shield ..... | 11   | $\mu\text{f}$ |
| Plate to Cathode, Heater, Grid No.2, Grid No.3, and Internal Shield....       | 5.5  | $\mu\text{f}$ |

|   |                                      |       |
|---|--------------------------------------|-------|
| <b>Maximum Ratings:</b>                       | <b>CLASS A<sub>1</sub> AMPLIFIER</b> |       |
| PLATE VOLTAGE .....                           | 300 <i>max</i>                       | volts |
| PLATE SUPPLY VOLTAGE .....                    | 300 <i>max</i>                       | volts |
| GRID-NO.3 (SUPPRESSOR) VOLTAGE .....          | 0 <i>max</i>                         | volts |
| GRID-NO.2 (SCREEN) SUPPLY VOLTAGE .....       | 300 <i>max</i>                       | volts |
| GRID-NO.2 VOLTAGE .....                       | 150 <i>max</i>                       | volts |
| GRID-NO.1 (CONTROL-GRID) VOLTAGE:             |                                      |       |
| Negative bias value .....                     | 50 <i>max</i>                        | volts |
| Positive bias value .....                     | 0 <i>max</i>                         | volts |
| PLATE DISSIPATION .....                       | 7.5 <i>max</i>                       | watts |
| GRID-NO.2 INPUT .....                         | 1.7 <i>max</i>                       | watts |
| PEAK HEATER-CATHODE VOLTAGE:                  |                                      |       |
| Heater negative with respect to cathode ..... | 90 <i>max</i>                        | volts |
| Heater positive with respect to cathode ..... | 90 <i>max</i>                        | volts |
| BULB TEMPERATURE (At hottest point) .....     | 200 <i>max</i>                       | °C    |

|   |                                |                  |
|---|--------------------------------|------------------|
| <b>Characteristics:</b>   |                                |                  |
| Plate Voltage .....   | 250                            | volts            |
| Grid-No.3 Voltage .....   | Connected to cathode at socket |                  |
| Grid-No.2 Voltage .....   | 150                            | volts            |
| Grid-No.1 Voltage .....   | -3                             | volts            |
| Peak AF Grid-No.1 Signal Voltage .....                                  | 3                              | volts            |
| Zero-Signal DC Plate Current .....                                      | 30                             | ma               |
| Maximum-Signal DC Plate Current .....                                   | 31                             | ma               |
| Zero-Signal DC Grid-No.2 Current .....                                  | 7                              | ma               |
| Maximum-Signal DC Grid-No.2 Current .....                               | 7.2                            | ma               |
| Plate Resistance (Approx.) .....  | 0.09                           | megohm           |
| Transconductance .....  | 11000                          | $\mu\text{mhos}$ |
| Grid-No.1 Voltage (Approx.) for plate current of 10 $\mu\text{a}$ ..... | -14                            | volts            |
| Load Resistance .....   | 7500                           | ohms             |
| Total Harmonic Distortion .....   | 8                              | per cent         |
| Maximum-Signal Power Output .....                                       | 2.8                            | watts            |

**Typical Operation in 4-Mc-Bandwidth Video Amplifier:**

|   |                                |        |
|---|--------------------------------|--------|
| Plate Supply Voltage .....                    | 300                            | volts  |
| Grid-No.3 Voltage .....                       | Connected to cathode at socket |        |
| Grid-No.2 Supply Voltage .....                | 300                            | volts  |
| Grid-No.1 Bias Voltage .....                  | -2                             | volts  |
| Grid-No.1 Signal Voltage (Peak to Peak) ..... | 3                              | volts  |
| Grid-No.2 Resistor .....                      | 24000                          | ohms   |
| Grid-No.1 Resistor .....                      | 0.1                            | megohm |
| Load Resistor .....                           | 3900                           | ohms   |
| Zero-Signal Plate Current .....               | 30                             | ma     |
| Zero-Signal Grid-No.2 Current .....           | 7.0                            | ma     |
| Voltage Output (Peak to Peak) .....           | 132                            | volts  |

**Maximum Circuit Values (For maximum rated conditions):**

|                                  |                |        |
|----------------------------------|----------------|--------|
| Grid-No.1 Circuit Resistance:    |                |        |
| For fixed-bias operation .....   | 0.1 <i>max</i> | megohm |
| For cathode-bias operation ..... | 0.5 <i>max</i> | megohm |

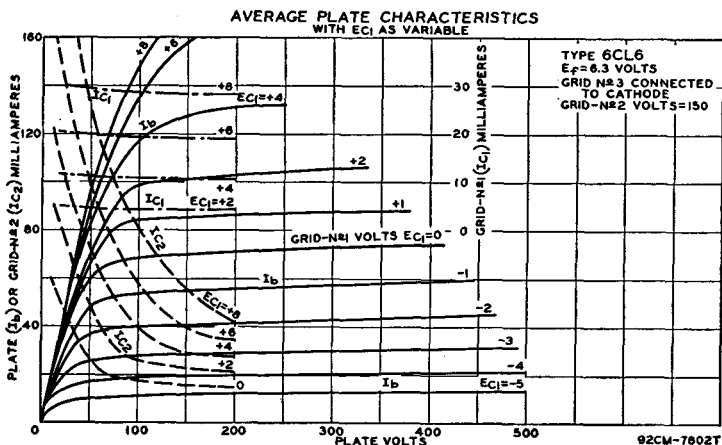

## 6D6

### REMOTE-CUTOFF PENTODE

Glass type used in rf and if stages of radio receivers employing avc. Outline 40, OUTLINES SECTION. Tube requires six-contact socket. Except for interelectrode capacitances, this type is identical electrically with type 6U7-G. Refer to type 6SK7 for general application information. Heater volts (ac/dc), 6.3; amperes, 0.3. This type is used principally for renewal purposes.

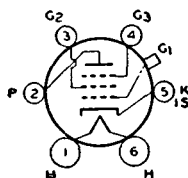

## 6D7

### SHARP-CUTOFF PENTODE

Glass type used as detector or amplifier in radio receivers. Outline 40, OUTLINES SECTION. Heater volts (ac/dc), 6.3; amperes, 0.3. For electrical characteristics, refer to type 6J7. Type 6D7 is a DISCONTINUED type listed for reference only.

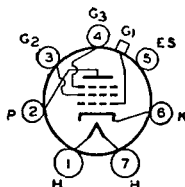

## 6D8-G

### PENTAGRID CONVERTER

Glass octal type used in superheterodyne circuits. Outline 35, OUTLINES SECTION. Tube requires octal socket. Heater volts (ac/dc), 6.3; amperes, 0.15. Except for interelectrode capacitances and heater rating, the 6D8-G is similar electrically to type 6A8-G. Type 6D8-G is a DISCONTINUED type listed for reference only.

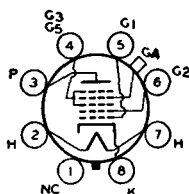

## 6DC6

### SEMIREMOTE-CUTOFF PENTODE

Miniature type used in the gain-controlled picture if stages of color television receivers. It is also used as a radio-frequency amplifier in the tuners of such receivers. Outline 13, OUTLINES SECTION. Tube requires seven-contact miniature socket and may be

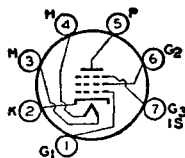

mounted in any position.

|   |          |               |
|---|----------|---------------|
| HEATER VOLTAGE (AC/DC) .....  | 6.3      | volts         |
| HEATER CURRENT .....  | 0.3      | ampere        |
| DIRECT INTERELECTRODE CAPACITANCES:                                     |          |               |
| Grid No.1 to Plate .....  | 0.02 max | $\mu\text{f}$ |
| Grid No.1 to Cathode, Heater, Grid No.2, Grid No.3, and Internal Shield | 6.5      | $\mu\text{f}$ |
| Plate to Cathode, Heater, Grid No.2, Grid No.3, and Internal Shield.... | 2        | $\mu\text{f}$ |

#### Maximum Ratings:

#### CLASS A<sub>1</sub> AMPLIFIER

|  |                   |       |
|--|-------------------|-------|
| PLATE VOLTAGE .....                                    | 300 max           | volts |
| GRID-NO.3 (SUPPRESSOR) VOLTAGE .....                   | 0 max             | volts |
| GRID-NO.2 SUPPLY VOLTAGE .....                         | 300 max           | volts |
| GRID-NO.2 (SCREEN) VOLTAGE .....                       | See curve page 64 |       |
| GRID-NO.1 (CONTROL-GRID) VOLTAGE:                      |                   |       |
| Positive bias value .....                              | 0 max             | volts |
| PLATE DISSIPATION .....                                | 2 max             | watts |
| GRID-NO.2 INPUT:                                       |                   |       |
| For grid-No.2 voltages up to 150 volts .....           | 0.5 max           | watt  |
| For grid-No.2 voltages between 150 and 300 volts ..... | See curve page 64 |       |
| PEAK HEATER-CATHODE VOLTAGE:                           |                   |       |
| Heater negative with respect to cathode .....          | 200 max           | volts |
| Heater positive with respect to cathode .....          | 200° max          | volts |

#### Typical Operation and Characteristics:

|  |                                |                  |
|--|--------------------------------|------------------|
| Plate Voltage .....  | 200                            | volts            |
| Grid No.3 .....  | Connected to cathode at socket |                  |
| Grid-No.2 Voltage .....  | 150                            | volts            |
| Cathode-Bias Resistor .....  | 180                            | ohms             |
| Plate Resistance (Approx.) .....   | 0.5                            | megohm           |
| Transconductance .....   | 5500                           | $\mu\text{mhos}$ |
| Grid-No.1 Bias (Approx.) for transconductance of 50 $\mu\text{mhos}$ ..... | -12.5                          | volts            |
| Plate Current .....  | 9                              | ma               |
| Grid-No.2 Current .....  | 3                              | ma               |

## Maximum Circuit Values (For maximum rated conditions):

|                                 |          |        |
|---------------------------------|----------|--------|
| Grid-No.1-Circuit Resistance:   |          |        |
| For fixed-bias operation.....   | 0.25 max | megohm |
| For cathode-bias operation..... | 1.0 max  | megohm |

\* The dc component must not exceed 100 volts.

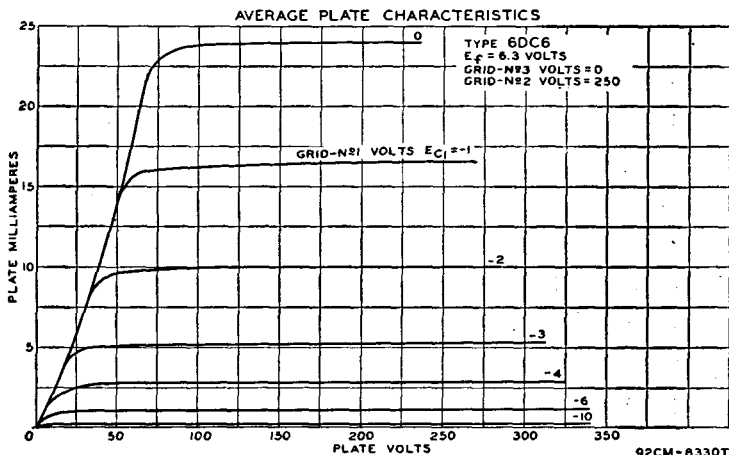

## ELECTRON-RAY TUBE

Glass type used to indicate visually by means of a fluorescent target the effects of a change in a controlling voltage. It is used as a convenient means of indicating accurate radio-receiver tuning. Outline 31, OUTLINES SECTION. Tube requires six-contact socket. Heater volts (ac/dc), 6.3; amperes, 0.3. For additional considerations, refer to *Tuning Indication with Electron-Ray Tubes* in ELECTRON TUBE APPLICATIONS SECTION.

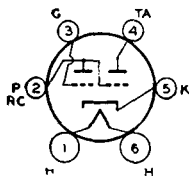

# 6E5

### Maximum Ratings:

|                           |           |       |
|---------------------------|-----------|-------|
| PLATE-SUPPLY VOLTAGE..... | 250 max   | volts |
| TARGET VOLTAGE.....       | { 250 max | volts |
|                           | { 125 min | volts |

### Typical Operation:

|                                   |      |      |        |
|-----------------------------------|------|------|--------|
| Plate and Target Supply.....      | 200  | 250  | volts  |
| Series Triode-Plate Resistor..... | 1    | 1    | megohm |
| Target Current*†.....             | 3    | 4    | ma     |
| Triode-Plate Current*.....        | 0.19 | 0.24 | ma     |
| Triode-Grid Voltage (Approx.):    |      |      |        |
| For shadow angle of 0°.....       | -6.5 | -8.0 | volts  |
| For shadow angle of 90°.....      | 0    | 0    | volts  |

\* For zero triode-grid voltage. † Subject to wide variations.

## TUNING INDICATOR

## TWIN POWER TRIODE

Glass type used as class A<sub>1</sub> amplifier in either push-pull or parallel circuits. Outline 38, OUTLINES SECTION. Heater volts (ac/dc), 6.3; amperes, 0.6. With plate volts of 250 and grid volts of -27.5, characteristics for each unit are: plate ma., 18; plate resistance, 3500 ohms; transconductance, 1700 μmhos; amplification factor, 6. With plate-to-plate load resistance

# 6E6

of 14000 ohms, output watts for two tubes is 1.6. This is a DISCONTINUED type listed for reference only.

**REMOTE-CUTOFF PENTODE**

Glass type used in rf and if stages of radio receivers employing avc. Outline 40, **OUTLINES SECTION**. Except for interelectrode capacitances, this type is identical electrically with type 6U7-G. Heater volts (ac/dc), 6.3; amperes, 0.3. This is a **DISCONTINUED** type listed for reference only.

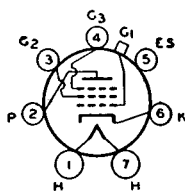

**6E7**

**HI-MU TRIODE**

Metal type 6F5 and glass-octal type 6F5-GT used in resistance-coupled amplifier circuits. Outlines 4 and 21, respectively, **OUTLINES SECTION**. Tubes require octal socket and may be mounted in any position. Type 6F5-GT may be supplied with pin No.1 omitted. For typical operation as a resistance-coupled amplifier, refer to Chart 17, **RESISTANCE-COUPLED AMPLIFIER SECTION**. For

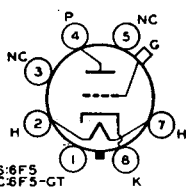

**6F5**  
**6F5-GT**

heater and cathode considerations, refer to type 6AV6. Heater volts (ac/dc), 6.3; amperes, 0.3. Typical operation as class A<sub>1</sub> amplifier: plate volts, 250 (300 max); grid volts, -2; amplification factor, 100; plate resistance, 66000 ohms; transconductance, 1500 μmhos; plate ma., 0.9. These types are used principally for renewal purposes.

**6F6**  
**6F6-G**  
**6F6-GT**

**POWER PENTODE**

Metal type 6F6 and glass-octal types 6F6-G and 6F6-GT are used in the audio output stage of ac receivers. They are capable of large power output with relatively small input voltage.

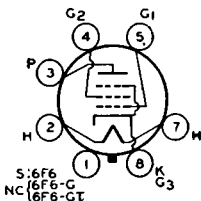

Outlines 6, 37, and 27, respectively, **OUTLINES SECTION**. Type 6F6-GT may be supplied with pin No.1 omitted. Tubes require octal socket and may be mounted in any position. It is especially important that these tubes, like other power-handling tubes, be adequately ventilated. Type 6F6-G is used principally for renewal purposes.

|                             |     |        |
|-----------------------------|-----|--------|
| HEATER VOLTAGE (AC/DC)..... | 6.3 | volts  |
| HEATER CURRENT.....         | 0.7 | ampere |

**Maximum Ratings: SINGLE-TUBE CLASS A<sub>1</sub> AMPLIFIER**

|  |          |       |
|--|----------|-------|
| PLATE VOLTAGE.....                           | 375 max  | volts |
| GRID-No.2 (SCREEN) VOLTAGE.....              | 285 max  | volts |
| PLATE DISSIPATION.....                       | 11 max   | watts |
| GRID-No.2 INPUT.....                         | 3.75 max | watts |
| <b>PEAK HEATER-CATHODE VOLTAGE:</b>          |          |       |
| Heater negative with respect to cathode..... | 90 max   | volts |
| Heater positive with respect to cathode..... | 90 max   | volts |

**Typical Operation:**

|                                    | <i>Fixed Bias</i> |       | <i>Cathode Bias</i> |      |          |
|------------------------------------|-------------------|-------|---------------------|------|----------|
| Plate Voltage.....                 | 250               | 285   | 250                 | 285  | volts    |
| Grid-No.2 Voltage.....             | 250               | 285   | 250                 | 285  | volts    |
| Grid-No.1 (Control-Grid) Voltage.. | -16.5             | -20   | -                   | -    | volts    |
| Cathode Resistor.....              | -                 | -     | 410                 | 440  | ohms     |
| Peak AF Grid-No.1 Voltage.....     | 16.5              | 20    | 16.5                | 20   | volts    |
| Zero-Signal Plate Current.....     | 34                | 38    | 34                  | 38   | ma       |
| Maximum-Signal Plate Current....   | 36                | 40    | 35                  | 38   | ma       |
| Zero-Signal Grid-No.2 Current....  | 6.5               | 7     | 6.5                 | 7    | ma       |
| Maximum-Signal Grid-No.2.....      |                   |       |                     |      |          |
| Current.....                       | 10.5              | 13    | 9.7                 | 12   | ma       |
| Plate Resistance (Approx.).....    | 80000             | 78000 | -                   | -    | ohms     |
| Transconductance.....              | 2500              | 2550  | -                   | -    | μmhos    |
| Load Resistance.....               | 7000              | 7000  | 7000                | 7000 | ohms     |
| Total Harmonic Distortion.....     | 8                 | 9     | 8.5                 | 9    | per cent |
| Maximum-Signal Power Output....    | 3.2               | 4.8   | 3.1                 | 4.5  | watts    |

**Maximum Ratings:**
**PUSH-PULL CLASS A<sub>1</sub> AMPLIFIER**

 (Same as for single-tube class A<sub>1</sub> amplifier)

**Typical Operation (Values are for two tubes):**

|   | Fixed Bias | Cathode Bias |          |
|---|------------|--------------|----------|
| Plate Voltage.....                              | 315        | 315          | volts    |
| Grid-No.2 Voltage.....                          | 285        | 285          | volts    |
| Grid-No.1 (Control-Grid) Voltage.....           | -24        | -            | volts    |
| Cathode Resistor.....                           | -          | 320          | ohms     |
| Peak AF Grid-No.1-to-Grid-No.1 Voltage.....     | 48         | 58           | volts    |
| Zero-Signal Plate Current.....                  | 62         | 62           | ma       |
| Maximum-Signal Plate Current.....               | 80         | 73           | ma       |
| Zero-Signal Grid-No.2 Current.....              | 12         | 12           | ma       |
| Maximum-Signal Grid-No.2 Current.....           | 19.5       | 18           | ma       |
| Effective Load Resistance (Plate-to-plate)..... | 10000      | 10000        | ohms     |
| Total Harmonic Distortion.....                  | 4          | 3            | per cent |
| Maximum-Signal Power Output.....                | 11         | 10.5         | watts    |

## MEDIUM-MU TRIODE— REMOTE-CUTOFF PENTODE

Glass type adaptable to circuit design in several ways. Except for common cathode, the triode and pentode units are independent of each other. Outline 36, OUTLINES SECTION. Heater volts (ac/dc), 6.3; amperes, 0.3. Typical operation of pentode unit as class A<sub>1</sub> amplifier: plate volts, 250 *max*; grid-No.2 volts, 100; grid-No.1 volts, -3; plate resistance, 0.85 megohm; transconductance, 1100  $\mu$ hos; plate ma.,

# 6F7

6.5; grid-No. 2 ma., 1.5. Typical operation of triode unit as class A amplifier: plate volts, 100 *max*; grid volts, -3; amplification factor, 8; plate resistance, 0.016 megohm; transconductance, 500  $\mu$ hos; plate ma., 3.5. This type is used principally for renewal purposes.

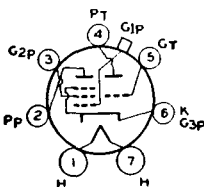

## MEDIUM-MU TWIN TRIODE

Glass octal type used as voltage amplifier or phase inverter in radio equipment. Except for common heater each triode is independent of the other. Outline 35, OUTLINES SECTION. Tube requires octal socket. Except for the heater rating of 6.3 volts (ac/dc) and 0.6 ampere and interelectrode capacitances, each triode unit is identical electrically with type 6J5. For typical operation as a resistance-coupled amplifier, refer to Chart 13, RESISTANCE-COUPLED AMPLIFIER SECTION. Type 6F8-G is used principally for renewal purposes.

# 6F8-G

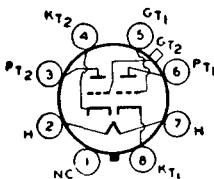

## POWER PENTODE

Glass octal type used in output stage of radio receivers where moderate power output is required. This type is economical because of its low plate-power requirements and low heater current. Outline 33, OUTLINES SECTION. Tube requires octal socket. Except for interelectrode capacitances and a plate resistance of 175000 ohms, this type is electrically identical amperes, 0.15. This type is used principally for renewal purposes.

# 6G6-G

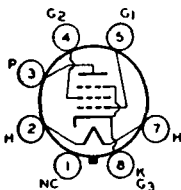

## TWIN DIODE

Metal type 6H6 and glass-octal type 6H6-GT are used as detectors, low-voltage rectifiers, and avc tubes. Except for the common heater, the two diode units are independent of

# 6H6 6H6-GT

each other. For diode detector considerations, refer to ELECTRON TUBE APPLICATIONS SECTION. Type 6H6-GT is used principally for renewal purposes.

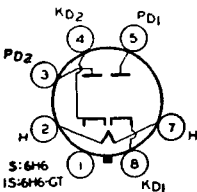

S: 6H6  
IS: 6H6-GT

|                                      |         |         |               |
|--------------------------------------|---------|---------|---------------|
| HEATER VOLTAGE (AC/DC).....          | 6.3     | volts   |               |
| HEATER CURRENT.....                  | 0.3     | ampere  |               |
| DIRECT INTERELECTRODE CAPACITANCES:† |         |         |               |
|                                      | 6H6     | 6H6-GT  |               |
| Plate No.1 to Cathode No.1.....      | 3.0     | 3.0     | $\mu\text{f}$ |
| Plate No.2 to Cathode No.2.....      | 3.4     | 4.0     | $\mu\text{f}$ |
| Plate No.1 to Plate No.2.....        | 0.1 max | 0.1 max | $\mu\text{f}$ |

† With shell or external and internal shields connected to cathode.

### Maximum Ratings: RECTIFIER OR DOUBLER

|  |         |       |
|--|---------|-------|
| PEAK INVERSE PLATE VOLTAGE.....              | 420 maz | volts |
| PEAK PLATE CURRENT PER PLATE.....            | 48 maz  | ma    |
| DC OUTPUT CURRENT PER PLATE.....             | 8 maz   | ma    |
| PEAK HEATER-CATHODE VOLTAGE:                 |         |       |
| Heater negative with respect to cathode..... | 330 maz | volts |
| Heater positive with respect to cathode..... | 330 maz | volts |

### Typical Operation (As Half-Wave Rectifier):\*

|  |     |     |       |
|--|-----|-----|-------|
| AC Plate Voltage per Plate (rms).....                                    | 117 | 150 | volts |
| Min. Total Effective Plate-Supply Impedance per Plate <sup>o</sup> ..... | 15  | 40  | ohms  |
| DC Output Current per Plate.....   | 8   | 8   | ma    |

### Typical Operation (As Voltage Doubler):

|  |                  |                  |       |
|--|------------------|------------------|-------|
|  | <i>Half-Wave</i> | <i>Full-Wave</i> |       |
| AC Plate Voltage per Plate (rms).....                                    | 117              | 117              | volts |
| Min. Total Effective Plate-Supply Impedance per Plate <sup>o</sup> ..... | 30               | 15               | ohms  |
| DC Output Current.....   | 8                | 8                | ma    |

\* In half-wave service, the two units may be used separately or in parallel.

<sup>o</sup> When a filter-input capacitor larger than 40  $\mu\text{f}$  is used, it may be necessary to use more plate-supply impedance than the value shown to limit the peak plate current to the rated value.

## INSTALLATION AND APPLICATION

Types 6H6 and 6H6-GT require an octal socket and may be mounted in any position. Type 6H6-GT may be supplied with pin No.1 omitted. Outlines 1 and 23 respectively, OUTLINES SECTION. For heater and cathode considerations, refer to type 6AV6.

For detection, the diodes may be utilized in a full-wave circuit or in a half-wave circuit. In the latter case, one plate only, or the two plates in parallel, may be employed. For the same signal voltage, the use of the half-wave arrangement will provide approximately twice the rectified voltage as compared with the full-wave arrangement.

For automatic-volume control, the 6H6 and 6H6-GT may be used in circuits similar to those employed for any of the twin-diode types of tubes. The only difference is that the 6H6 and 6H6-GT are more adaptable because each diode has its own separate cathode.

### MEDIUM-MU TRIODE

## 6J5 6J5-GT

Metal type 6J5 and glass-octal type 6J5-GT used as detectors, amplifiers, or oscillators in radio equipment. These types feature high transconductance together with comparatively

high amplification factor. Outlines 3 and 25, respectively, OUTLINES SECTION. Tubes require octal socket and may be mounted in any position. For heater and cathode considerations, refer to type 6AV6. For typical operation as resistance-coupled amplifiers, refer to Chart 13, RESISTANCE-COUPLED AMPLIFIER SECTION.

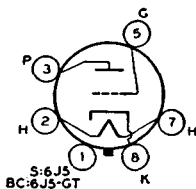

|   |      |          |               |
|---|------|----------|---------------|
| HEATER VOLTAGE (AC/DC).....                   | 6.3  | volts    |               |
| HEATER CURRENT.....                           | 0.3  | ampere   |               |
| DIRECT INTERELECTRODE CAPACITANCES (Approx.): | 6J5* | 6J5-GT** |               |
| Grid to Plate.....                            | 3.4  | 3.8      | $\mu\text{f}$ |
| Grid to Cathode and Heater.....               | 3.4  | 4.2      | $\mu\text{f}$ |
| Plate to Cathode and Heater.....              | 3.6  | 5.0      | $\mu\text{f}$ |

\* Shell connected to cathode.      \*\*Base sleeve and external shield connected to cathode.

### Maximum Ratings:

### CLASS A<sub>1</sub> AMPLIFIER

|  |         |       |
|--|---------|-------|
| PLATE VOLTAGE.....                           | 300 max | volts |
| GRID VOLTAGE, Positive Bias Value.....       | 0 max   | volts |
| PLATE DISSIPATION.....                       | 2.5 max | watts |
| PEAK HEATER-CATHODE VOLTAGE:                 |         |       |
| Heater negative with respect to cathode..... | 90 max  | volts |
| Heater positive with respect to cathode..... | 90 max  | volts |
| CATHODE CURRENT.....                         | 20 max  | ma    |

### Typical Operation:

|   |      |      |                  |
|---|------|------|------------------|
| Plate Voltage.....  | 90   | 250  | volts            |
| Grid Voltage.....   | 0    | -8   | volts            |
| Amplification Factor.....                                       | 20   | 20   |                  |
| Plate Resistance.....   | 6700 | 7700 | ohms             |
| Transconductance.....   | 3000 | 2600 | $\mu\text{mhos}$ |
| Grid Bias (Approx.) for plate current of 10 $\mu\text{a}$ ..... | -7   | -18  | volts            |
| Plate Current.....  | 10   | 9    | ma               |

### Maximum Circuit Value:

|                              |         |        |
|------------------------------|---------|--------|
| Grid-Circuit Resistance..... | 1.0 max | megohm |
|------------------------------|---------|--------|

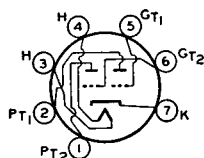
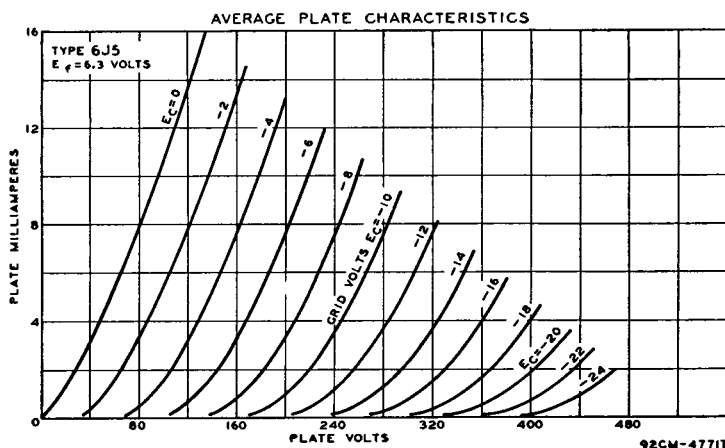

## MEDIUM-MU TWIN TRIODE

Miniature type used as an rf power amplifier and oscillator or as an af amplifier. With a push-pull arrangement of the grids and with the plates in parallel, it is also used as a mixer at

# 6J6

frequencies as high as 600 megacycles per second. Outline 13, OUTLINES SECTION. Tube requires miniature seven-contact socket and may be mounted in any position. For heater and cathode considerations, refer to type 6AQ5.

|  |      |               |
|--|------|---------------|
| HEATER VOLTAGE (AC/DC).....                              | 6.3  | volts         |
| HEATER CURRENT.....                                      | 0.45 | ampere        |
| DIRECT INTERELECTRODE CAPACITANCES (Each Unit, Approx.): |      |               |
| Grid to Plate.....                                       | 1.6  | $\mu\text{f}$ |
| Grid to Cathode and Heater.....                          | 2.2  | $\mu\text{f}$ |
| Plate to Cathode and Heater.....                         | 0.4  | $\mu\text{f}$ |

## Maximum Ratings: CLASS A<sub>1</sub> AF AMPLIFIER

|  |                |       |
|--|----------------|-------|
| PLATE VOLTAGE.....                           | 300 <i>max</i> | volts |
| PLATE DISSIPATION (PER UNIT).....            | 1.5 <i>max</i> | watts |
| PEAK HEATER-CATHODE VOLTAGE:                 |                |       |
| Heater negative with respect to cathode..... | 100 <i>max</i> | volts |
| Heater positive with respect to cathode..... | 100 <i>max</i> | volts |

## Typical Operation (Each Unit):

|                            |               |                  |
|----------------------------|---------------|------------------|
| Plate Voltage.....         | 100           | volts            |
| Cathode-Bias Resistor..... | 50 $\uparrow$ | ohms             |
| Amplification Factor.....  | 38            |                  |
| Plate Resistance.....      | 7100          | ohms             |
| Transconductance.....      | 5300          | $\mu\text{mhos}$ |
| Plate Current.....         | 8.5           | ma               |

## Maximum Circuit Values (For maximum rated conditions):

|                                 |  |                       |
|---------------------------------|--|-----------------------|
| Grid-Circuit Resistance:        |  |                       |
| For fixed-bias operation.....   |  | Not recommended       |
| For cathode-bias operation..... |  | 0.5 <i>max</i> megohm |

$\uparrow$  Value is for both units operating at the specified conditions.

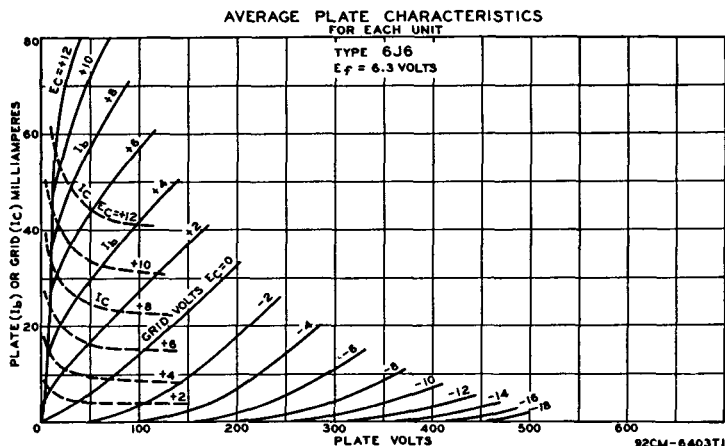

## RF POWER AMPLIFIER AND OSCILLATOR—Class C Telegraphy

Values are for both units, unless otherwise specified.

### Maximum Ratings:

|  |                |       |
|--|----------------|-------|
| DC PLATE VOLTAGE.....                        | 300 <i>max</i> | volts |
| DC GRID VOLTAGE.....                         | -40 <i>max</i> | volts |
| DC PLATE CURRENT (PER UNIT).....             | 15 <i>max</i>  | ma    |
| DC GRID CURRENT (PER UNIT).....              | 8 <i>max</i>   | ma    |
| DC PLATE INPUT (PER UNIT).....               | 4.5 <i>max</i> | watts |
| PLATE DISSIPATION (PER UNIT).....            | 1.5 <i>max</i> | watts |
| PEAK HEATER-CATHODE VOLTAGE:                 |                |       |
| Heater negative with respect to cathode..... | 100 <i>max</i> | volts |
| Heater positive with respect to cathode..... | 100 <i>max</i> | volts |



### Typical Operation:†

|                                |      |       |
|--------------------------------|------|-------|
| DC Plate Voltage.....          | 150  | volts |
| DC Grid Voltage°.....          | -10  | volts |
| DC Plate Current.....          | 30   | ma    |
| DC Grid Current (Approx.)..... | 16   | ma    |
| Driving Power (Approx.).....   | 0.35 | watt  |
| Power Output (Approx.).....    | 3.5  | watts |

† At moderate frequencies in push-pull. Key-down conditions without modulation. At 250 Mc, approximately 1.0 watt can be obtained when the 6J6 is used as a push-pull oscillator with a plate voltage of 150 volts, with maximum rated plate dissipation, and with a grid resistor of 2000 ohms common to both units.

° Obtained by grid resistor (625 ohms), cathode resistor (220 ohms), or fixed supply.

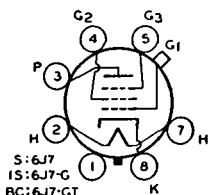

## SHARP-CUTOFF PENTODE

Metal type 6J7 and glass-octal types 6J7-G and 6J7-GT are used as biased detectors or high-gain audio amplifiers in radio receivers. Outlines 4, 35, and 24, respectively, OUTLINES

SECTION. Type 6J7-GT is used principally for renewal purposes. Type 6J7-G is a DISCONTINUED type listed for reference only. All types require octal socket and may be mounted in any position. For typical operation as resistance-coupled amplifiers, refer to Charts 11 and 14, RESISTANCE-COUPLED AMPLIFIER SECTION. For heater and cathode considerations, refer to type 6AV6.

# 6J7 6J7-G 6J7-GT

|                             |     |        |
|-----------------------------|-----|--------|
| HEATER VOLTAGE (AC/DC)..... | 6.3 | volts  |
| HEATER CURRENT.....         | 0.3 | ampere |

### Maximum Ratings: CLASS A<sub>1</sub> AMPLIFIER (Pentode Connection)

|  |                   |       |
|--|-------------------|-------|
| PLATE VOLTAGE.....   | 300 max           | volts |
| GRID-NO.2 (SCREEN) VOLTAGE.....                            | See curve page 64 |       |
| GRID-NO.2 SUPPLY VOLTAGE.....                              | 300 max           | volts |
| GRID-NO.1 (CONTROL-GRID) VOLTAGE, Positive Bias Value..... | 0 max             | volts |
| PLATE DISSIPATION.....                                     | 0.75 max          | watt  |

#### GRID-NO.2 INPUT:

|   |                   |      |
|---|-------------------|------|
| For grid-No.2 voltages up to 150 volts.....           | 0.10 max          | watt |
| For grid-No.2 voltages between 150 and 300 volts..... | See curve page 64 |      |

#### PEAK HEATER-CATHODE VOLTAGE:

|  |        |       |
|--|--------|-------|
| Heater negative with respect to cathode..... | 90 max | volts |
| Heater positive with respect to cathode..... | 90 max | volts |

### Typical Operation:

|  |                                |      |        |
|--|--------------------------------|------|--------|
| Plate Voltage.....                                       | 100                            | 250  | volts  |
| Grid No.3 (Suppressor).....                              | Connected to cathode at socket |      |        |
| Grid-No.2 Voltage.....                                   | 100                            | 100  | volts  |
| Grid-No.1 Voltage.....                                   | -3                             | -3   | volts  |
| Plate Resistance.....                                    | 1.0                            | *    | megohm |
| Transconductance.....                                    | 1185                           | 1225 | μmhos  |
| Grid-No.1 Bias (Approx.) for cathode-current cutoff..... | -7                             | -7   | volts  |
| Plate Current.....                                       | 2                              | 2    | ma     |
| Grid-No.2 Current.....                                   | 0.5                            | 0.5  | ma     |

### Maximum Circuit Value:

|                                   |         |        |
|-----------------------------------|---------|--------|
| Grid-No.1-Circuit Resistance..... | 1.0 max | megohm |
|-----------------------------------|---------|--------|

### Maximum Ratings: CLASS A<sub>1</sub> AMPLIFIER (Triode Connection)°

|  |          |       |
|--|----------|-------|
| PLATE VOLTAGE.....                           | 250 max  | volts |
| GRID-NO.1 VOLTAGE, Positive Bias Value.....  | 0 max    | volts |
| PLATE AND GRID-NO.2 DISSIPATION (TOTAL)..... | 1.75 max | watts |

### Typical Operation:

|                           |       |       |       |
|---------------------------|-------|-------|-------|
| Plate Voltage.....        | 180   | 250   | volts |
| Grid-No.1 Voltage.....    | -5.3  | -8    | volts |
| Amplification Factor..... | 20    | 20    |       |
| Plate Resistance.....     | 11000 | 10500 | ohms  |
| Transconductance.....     | 1800  | 1900  | μmhos |
| Plate Current.....        | 5.3   | 6.5   | ma    |

**Maximum Circuit Value:**

- Grid-No.1-Circuit Resistance..... 1.0 *maz* megohm
- \* Greater than 1.0 megohm.
- ° Grids No.2 and No.3 connected to plate.

## TRIODE—HEPTODE CONVERTER

### 6J8-G

Glass octal type used as a combined triode oscillator and heptode mixer in radio receivers. Outline 35, OUTLINES SECTION. Tube requires octal socket. Heater volts (ac/dc), 6.3; amperes, 0.3. Typical operation—Heptode unit: plate volts, 250 (300 *maz*); grids-No.2-and-No.4 volts, 100 *maz*; grid-No.1 volts, -3; plate resistance, 1.5 megohms; conversion transconductance, 290  $\mu$ mhos; plate ma., 1.4; grids-No.2-and-No.4 ma., 2.8. Triode unit: plate volts, 250 *maz* (applied through 20000-ohm dropping resistor); grid resistor, 50000 ohms; plate ma., 5.0. This type is used principally for renewal purposes.

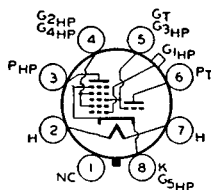

## HIGH-MU TRIODE

### 6K5-GT

Glass octal type used as voltage amplifier in radio equipment. Outline 24, OUTLINES SECTION. Tube requires octal socket. Heater volts (ac/dc), 6.3; amperes, 0.3. Characteristics as class A<sub>1</sub> amplifier: plate volts, 250 *maz*; grid volts, -3; amplification factor, 70; plate resistance, 50000 ohms; transconductance, 1400  $\mu$ mhos; plate ma., 1.1. This is a DISCONTINUED type listed for reference only.

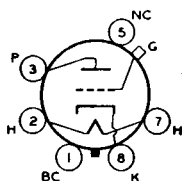

## POWER PENTODE

### 6K6-GT

Glass octal type used in output stage of radio receivers and, triode-connected, as a vertical deflection amplifier in television receivers. It is capable of delivering moderate power output with relatively small input voltage. Tube may be used singly or in push-pull. This type may be supplied with pin No.1 omitted. Tube requires octal socket and may be mounted in any position. Outline 23, OUTLINES SECTION. It is especially important that this tube, like other power-handling tubes, be adequately ventilated.

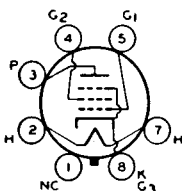

|   |     |         |
|---|-----|---------|
| HEATER VOLTAGE (AC/DC).....                                 | 6.3 | volts   |
| HEATER CURRENT.....   | 0.4 | ampere  |
| DIRECT INTERELECTRODE CAPACITANCES (Approx.):               |     |         |
| Grid No.1 to Plate.....                                     | 0.5 | $\mu$ f |
| Grid No.1 to Cathode, Heater, Grid No.2, and Grid No.3..... | 5.5 | $\mu$ f |
| Plate to Cathode, Heater, Grid No.2, and Grid No.3.....     | 6.0 | $\mu$ f |

**Maximum Ratings:**

### CLASS A<sub>1</sub> AMPLIFIER (Pentode Connection)

|  |                 |       |
|--|-----------------|-------|
| PLATE VOLTAGE.....   | 315 <i>maz</i>  | volts |
| GRID-NO.2 (SCREEN) VOLTAGE.....                            | 285 <i>maz</i>  | volts |
| PLATE DISSIPATION.....                                     | 8.5 <i>maz</i>  | watts |
| GRID-NO.2 INPUT.....                                       | 2.8 <i>maz</i>  | watts |
| GRID-NO.1 (CONTROL-GRID) VOLTAGE, Positive Bias Value..... | 0 <i>maz</i>    | volts |
| PEAK HEATER-CATHODE VOLTAGE:                               |                 |       |
| Heater negative with respect to cathode.....               | 200 <i>maz</i>  | volts |
| Heater positive with respect to cathode.....               | 200* <i>maz</i> | volts |

\* The dc component must not exceed 100 volts.

**Typical Operation:**

|                                       |     |     |     |       |
|---------------------------------------|-----|-----|-----|-------|
| Plate Voltage.....                    | 100 | 250 | 315 | volts |
| Grid-No.2 Voltage.....                | 100 | 250 | 250 | volts |
| Grid-No.1 (Control-Grid) Voltage..... | -7  | -18 | -21 | volts |
| Peak AF Grid-No.1 Voltage.....        | 7   | 18  | 21  | volts |

# RCA Receiving Tube Manual

|                                       |        |       |        |            |
|---------------------------------------|--------|-------|--------|------------|
| Zero-Signal Plate Current.....        | 9      | 32    | 25.5   | ma         |
| Maximum-Signal Plate Current.....     | 9.5    | 33    | 28     | ma         |
| Zero-Signal Grid-No.2 Current.....    | 1.6    | 5.5   | 4.0    | ma         |
| Maximum-Signal Grid-No.2 Current..... | 3      | 10    | 9      | ma         |
| Plate Resistance (Approx.).....       | 104000 | 90000 | 110000 | ohms       |
| Transconductance.....                 | 1500   | 2300  | 2100   | $\mu$ mhos |
| Load Resistance.....                  | 12000  | 7600  | 9000   | ohms       |
| Total Harmonic Distortion.....        | 11     | 11    | 15     | per cent   |
| Maximum-Signal Power Output.....      | 0.35   | 3.4   | 4.5    | watts      |

| Typical Push-Pull Operation (Values are for two tubes): | Fixed Bias | Cathode Bias |          |
|---|------------|--------------|----------|
| Plate Voltage.....                                      | 285        | 285          | volts    |
| Grid-No.2 Voltage.....                                  | 285        | 285          | volts    |
| Grid-No.1 (Control-Grid) Voltage.....                   | -25.5      | -            | volts    |
| Cathode Resistor.....                                   | -          | 400          | ohms     |
| Peak AF Grid-No.1-to-Grid-No.1 Voltage.....             | 51         | 51           | volts    |
| Zero-Signal Plate Current.....                          | 55         | 55           | ma       |
| Maximum-Signal Plate Current.....                       | 72         | 61           | ma       |
| Zero-Signal Grid-No.2 Current.....                      | 9          | 9            | ma       |
| Maximum-Signal Grid-No.2 Current.....                   | 17         | 13           | ma       |
| Effective Load Resistance (Plate-to-plate).....         | 12000      | 12000        | ohms     |
| Total Harmonic Distortion.....                          | 6          | 4            | per cent |
| Maximum-Signal Power Output.....                        | 10.5       | 9.8          | watts    |

### Maximum Circuit Values:

|                                 |         |        |
|---------------------------------|---------|--------|
| Grid-No.1-Circuit Resistance:   |         |        |
| For fixed-bias operation.....   | 0.1 max | megohm |
| For cathode-bias operation..... | 0.5 max | megohm |

### Characteristics (Triode Connection)\*:

|   |      |            |
|---|------|------------|
| Plate Voltage.....                                      | 250  | volts      |
| Grid-No.1 Voltage.....                                  | -18  | volts      |
| Plate Current.....                                      | 37.5 | ma         |
| Transconductance.....                                   | 2700 | $\mu$ mhos |
| Amplification Factor.....                               | 6.8  |            |
| Plate Resistance (Approx.).....                         | 2500 | ohms       |
| Grid Voltage (Approx.) for plate current of 0.5 ma..... | -48  | volts      |

\* Grid-No.2 connected to plate.

AVERAGE PLATE CHARACTERISTICS  
PENTODE CONNECTION

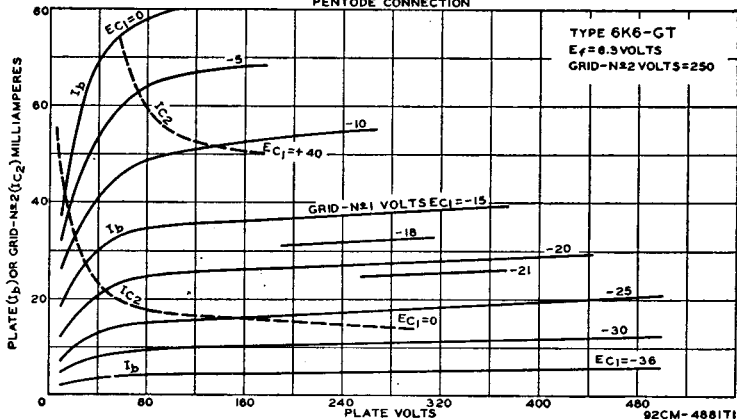

### VERTICAL DEFLECTION AMPLIFIER (Triode Connection)\*

For operation in a 525-line, 50-frame system

|  |          |       |
|--|----------|-------|
| <b>Maximum Ratings:</b>                                    |          |       |
| DC PLATE VOLTAGE.....                                      | 315 max  | volts |
| PEAK POSITIVE-PULSE PLATE VOLTAGE† (Absolute maximum)..... | 1200 max | volts |
| PEAK NEGATIVE-PULSE GRID-NO.1 VOLTAGE.....                 | -250 max | volts |
| <b>CATHODE CURRENT:</b>                                    |          |       |
| Peak.....  | 75 max   | ma    |
| DC.....  | 25 max   | ma    |
| <b>PLATE DISSIPATION.....</b>                              | 7 max    | watts |
| <b>PEAK HEATER-CATHODE VOLTAGE:</b>                        |          |       |
| Heater negative with respect to cathode.....               | 200 max  | volts |
| Heater positive with respect to cathode.....               | 200 max  | volts |

## Maximum Circuit Value:

Grid-No.1-Circuit Resistance:

For cathode-bias operation..... 2.2 *max* megohms

\* Grid No.2 connected to plate.

† The duration of the voltage pulse must not exceed 15 per cent of one vertical scanning cycle. In a 525-line, 30-frame system, 15 per cent of one vertical scanning cycle is 2.5 milliseconds.

° Under no circumstances should this absolute value be exceeded.

■ The dc component must not exceed 100 volts.

## 6K7 6K7-G 6K7-GT

### REMOTE-CUTOFF PENTODE

Metal type 6K7 and glass-octal types 6K7-G and 6K7-GT used in rf and if stages of radio receivers, particularly in those employing avc. Outlines 4, 35, and 24, respectively, OUTLINES SECTION. These tubes require octal socket and may be mounted in any position. For electrode voltage supplies and application, refer to type 6SK7. For heater and cathode

considerations, refer to type 6AV6. Heater volts (ac/dc), 6.3; amperes, 0.3. Typical operation and maximum ratings as class A1 amplifier: plate volts 250 (300 *max*); grid No.3 connected to cathode at socket; grid-No.2 supply volts, 300 *max*; grid-No.2 volts, 125; grid-No.1 volts, -3; plate resistance, 0.6 megohm; transconductance, 1650  $\mu$ mhos; plate ma., 10.5; grid-No.2 ma., 2.6; plate dissipation, 2.75 *max* watts; grid-No.2 input, 0.35 *max* watts. These types are used principally for renewal purposes.

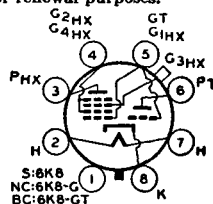
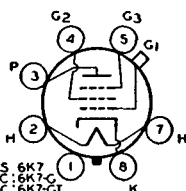

### TRIODE-HEXODE CONVERTER

Metal type 6K8 and glass-octal types 6K8-G and 6K8-GT used as combined triode oscillator and hexode mixer in radio receivers. Type 6K8, Outline 5, type 6K8-G, Outline 35,

OUTLINES SECTION. Types 6K8-G and 6K8-GT are DISCONTINUED types listed for reference only. Tubes require octal socket and may be mounted in any position. For heater and cathode considerations, refer to type 6AV6. For application, refer to *Frequency Conversion* in ELECTRON TUBE APPLICATIONS SECTION.

|                             |     |        |
|-----------------------------|-----|--------|
| HEATER VOLTAGE (AC/DC)..... | 6.3 | volts  |
| HEATER CURRENT.....         | 0.3 | ampere |

## Maximum Ratings:

### CONVERTER SERVICE

|   |                 |       |
|---|-----------------|-------|
| HEXODE PLATE VOLTAGE.....   | 300 <i>max</i>  | volts |
| HEXODE GRIDS-NO.2-AND-NO.4 (SCREEN) VOLTAGE.....                  | 150 <i>max</i>  | volts |
| HEXODE GRIDS-NO.2-AND-NO.4 SUPPLY VOLTAGE.....                    | 300 <i>max</i>  | volts |
| HEXODE GRID-NO.3 (CONTROL-GRID) VOLTAGE, Positive Bias Value..... | 0 <i>max</i>    | volts |
| TRIODE PLATE VOLTAGE.....   | 125 <i>max</i>  | volts |
| HEXODE PLATE DISSIPATION.....                                     | 0.75 <i>max</i> | watt  |
| HEXODE GRIDS-NO.2-AND-NO.4 INPUT.....                             | 0.7 <i>max</i>  | watt  |
| TRIODE PLATE DISSIPATION.....                                     | 0.75 <i>max</i> | watt  |
| TOTAL CATHODE CURRENT.....  | 16 <i>max</i>   | ma    |
| <b>PEAK HEATER-CATHODE VOLTAGE:</b>                               |                 |       |
| Heater negative with respect to cathode.....                      | 90 <i>max</i>   | volts |
| Heater positive with respect to cathode.....                      | 90 <i>max</i>   | volts |

## Typical Operation:

|   |       |       |            |
|---|-------|-------|------------|
| Hexode Plate Voltage.....   | 100   | 250   | volts      |
| Hexode Grids-No.2-and-No.4 Voltage.....   | 100   | 100   | volts      |
| Hexode Grid-No.3 Voltage.....   | -3    | -3    | volts      |
| Triode Plate Voltage.....   | 100   | 100   | volts      |
| Triode Grid Resistor.....   | 50000 | 50000 | ohms       |
| Hexode Plate Resistance (Approx.).....  | 0.4   | 0.6   | megohm     |
| Conversion Transconductance.....  | 325   | 350   | $\mu$ mhos |
| Hexode Grid-No.3 Voltage (Approx.) for conversion transconductance of 2 $\mu$ mhos..... | -30   | -30   | volts      |
| Hexode Plate Current.....   | 2.3   | 2.5   | ma         |
| Hexode Grids-No.2-and-No.4 Current.....   | 6.2   | 6.0   | ma         |
| Triode Plate Current.....   | 3.8   | 3.8   | ma         |
| Triode Grid and Hexode Grid-No.1 Current.....   | 0.15  | 0.15  | ma         |
| Total Cathode Current.....  | 12.5  | 12.5  | ma         |

The transconductance of the triode section, not oscillating, of the 6K8 is approximately 3000  $\mu$ mhos when the triode plate voltage is 100 volts, and the triode grid voltage is 0 volts.

## MEDIUM-MU TRIODE

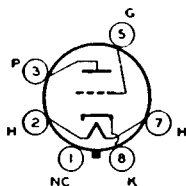

Glass octal type used as detector, amplifier, or oscillator in radio receivers. Outline 33, OUTLINES SECTION. Heater volts (ac/dc), 6.3; amperes, 0.15. Typical operation and characteristics: plate volts, 250 *max*; grid volts, -9; plate ma., 8; plate resistance, 9000 ohms; amplification factor, 17; transconductance, 1900  $\mu$ mhos; grid-bias volts for cathode-current cutoff, -20. This is a DISCONTINUED type listed for reference only.

### 6L5-G

## BEAM POWER TUBE

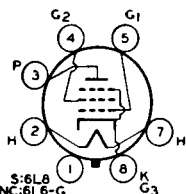

Metal type 6L6 and glass-octal type 6L6-G are used in output stage of radio receivers and amplifiers, especially those designed to have ample reserve of power-delivering ability.

### 6L6 6L6-G

These types provide high power output, sensitivity, and high efficiency. Power output at all levels has low third and negligible higher-order harmonics. For discussion of beam power tube considerations, refer to ELECTRONS, ELECTRODES, AND ELECTRON TUBES SECTION.

|  |     |          |
|--|-----|----------|
| HEATER VOLTAGE (AC/DC).....                              | 6.3 | volts    |
| HEATER CURRENT.....                                      | 0.9 | ampere   |
| DIRECT INTERELECTRODE CAPACITANCES (Approx.)*:           |     |          |
| Grid No.1 to Plate.....                                  | 0.4 | $\mu$ mf |
| Grid No.1 to Cathode, Heater, Grid No.2, and Grid No.3.. | 10  | $\mu$ mf |
| Plate to Cathode, Heater, Grid No.2, and Grid No.3.....  | 12  | $\mu$ mf |

\* Pin No.1 connected to pin No.8.

### SINGLE-TUBE CLASS A<sub>1</sub> AMPLIFIER

|  |                |       |  |
|--|----------------|-------|--|
| Maximum Ratings:                             |                |       |  |
| PLATE VOLTAGE.....                           | 360 <i>max</i> | volts |  |
| GRID-NO.2 (SCREEN) VOLTAGE.....              | 270 <i>max</i> | volts |  |
| PLATE DISSIPATION.....                       | 19 <i>max</i>  | watts |  |
| GRID-NO.2 INPUT.....                         | 2.5 <i>max</i> | watts |  |
| PEAK HEATER-CATHODE VOLTAGE:                 |                |       |  |
| Heater negative with respect to cathode..... | 180 <i>max</i> | volts |  |
| Heater positive with respect to cathode..... | 180 <i>max</i> | volts |  |

|                                       |       |                   |      |                     |            |
|---------------------------------------|-------|-------------------|------|---------------------|------------|
| Typical Operation:                    |       | <i>Fixed Bias</i> |      | <i>Cathode Bias</i> |            |
| Plate Voltage.....                    | 250   | 350               | 250  | 300                 | volts      |
| Grid-No.2 Voltage.....                | 250   | 250               | 250  | 200                 | volts      |
| Grid-No.1 (Control-Grid) Voltage..... | -14   | -18               | -    | -                   | volts      |
| Cathode Resistor.....                 | -     | -                 | 170  | 220                 | ohms       |
| Peak AF Grid-No.1 Voltage.....        | 14    | 18                | 14   | 12.5                | volts      |
| Zero-Signal Plate Current.....        | 72    | 54                | 75   | 51                  | ma         |
| Maximum-Signal Plate Current.....     | 79    | 66                | 78   | 54.5                | ma         |
| Zero-Signal Grid-No.2 Current.....    | 5     | 2.5               | 5.4  | 3                   | ma         |
| Maximum-Signal Grid-No.2 Current..... | 7.3   | 7                 | 7.2  | 4.6                 | ma         |
| Plate Resistance.....                 | 22500 | 33000             | -    | -                   | ohms       |
| Transconductance.....                 | 6000  | 5200              | -    | -                   | $\mu$ mhos |
| Load Resistance.....                  | 2500  | 4200              | 2500 | 4500                | ohms       |
| Total Harmonic Distortion.....        | 10    | 15                | 10   | 11                  | per cent   |
| Maximum-Signal Power Output.....      | 6.5   | 10.8              | 6.5  | 6.5                 | watts      |

### SINGLE-TUBE CLASS A<sub>1</sub> AMPLIFIER (Triode Connection)†

|  |                 |       |  |
|--|-----------------|-------|--|
| Maximum Ratings:                             |                 |       |  |
| PLATE VOLTAGE.....                           | 275 <i>max</i>  | volts |  |
| PLATE AND GRID-NO.2 DISSIPATION (TOTAL)..... | 12.5 <i>max</i> | watts |  |
| PEAK HEATER-CATHODE VOLTAGE:                 |                 |       |  |
| Heater negative with respect to cathode..... | 180 <i>max</i>  | volts |  |
| Heater positive with respect to cathode..... | 180 <i>max</i>  | volts |  |

# RCA Receiving Tube Manual

## Typical Operation:

|                                       | Fixed Bias | Cathode Bias |          |
|---------------------------------------|------------|--------------|----------|
| Plate Voltage.....                    | 250        | 250          | volts    |
| Grid-No.1 (Control-Grid) Voltage..... | -20        | -            | volts    |
| Cathode Resistor.....                 | -          | 490          | ohms     |
| Peak AF Grid-No.1 Voltage.....        | 20         | 20           | volts    |
| Zero-Signal Plate Current.....        | 40         | 40           | ma       |
| Maximum-Signal Plate Current.....     | 44         | 42           | ma       |
| Plate Resistance.....                 | 1700       | -            | ohms     |
| Amplification Factor.....             | 8          | -            |          |
| Transconductance.....                 | 4700       | -            | μmhos    |
| Load Resistance.....                  | 6000       | 6000         | ohms     |
| Total Harmonic Distortion.....        | 5          | 6            | per cent |
| Maximum-Signal Power Output.....      | 1.4        | 1.3          | watts    |

† Grid No.2 connected to plate.

## Maximum Ratings: PUSH-PULL CLASS A<sub>1</sub> AMPLIFIER

(Same as for single-tube class A<sub>1</sub> amplifier)

### Typical Operation (Values are for two tubes)

|   | Fixed Bias |       | Cathode Bias |          |
|---|------------|-------|--------------|----------|
| Plate Voltage.....                              | 250        | 270   | 270          | volts    |
| Grid-No.2 Voltage.....                          | 250        | 270   | 270          | volts    |
| Grid-No.1 (Control-Grid) Voltage.....           | -16        | -17.5 | -            | volts    |
| Cathode Resistor.....                           | -          | -     | 125          | ohms     |
| Peak AF Grid-No.1-to-Grid-No.1 Voltage.....     | 32         | 35    | 28.2         | volts    |
| Zero-Signal Plate Current.....                  | 120        | 134   | 134          | ma       |
| Maximum-Signal Plate Current.....               | 140        | 155   | 145          | ma       |
| Zero-Signal Grid-No.2 Current.....              | 10         | 11    | 11           | ma       |
| Maximum-Signal Grid-No.2 Current.....           | 16         | 17    | 17           | ma       |
| Plate Resistance.....                           | 24500      | 23500 | -            | ohms     |
| Transconductance.....                           | 5500       | 5700  | -            | μmhos    |
| Effective Load Resistance (Plate-to-plate)..... | 5000       | 5000  | 5000         | ohms     |
| Total Harmonic Distortion.....                  | 2          | 2     | 2            | per cent |
| Maximum-Signal Power Output.....                | 14.5       | 17.5  | 18.5         | watts    |

## Maximum Ratings: PUSH-PULL CLASS AB<sub>1</sub> AMPLIFIER

(Same as for single-tube class A<sub>1</sub> amplifier)

### Typical Operation (Values are for two tubes):

|   | Fixed Bias |       | Cathode Bias |          |
|---|------------|-------|--------------|----------|
| Plate Voltage.....                              | 360        | 360   | 360          | volts    |
| Grid-No.2 Voltage.....                          | 270        | 270   | 270          | volts    |
| Grid-No.1 (Control-Grid) Voltage.....           | -22.5      | -22.5 | -            | volts    |
| Cathode Resistor.....                           | -          | -     | 250          | ohms     |
| Peak AF Grid-No.1-to-Grid-No.1 Voltage.....     | 45         | 45    | 40.6         | volts    |
| Zero-Signal Plate Current.....                  | 88         | 88    | 88           | ma       |
| Maximum-Signal Plate Current.....               | 132        | 140   | 100          | ma       |
| Zero-Signal Grid-No.2 Current.....              | 5          | 5     | 5            | ma       |
| Maximum-Signal Grid-No.2 Current.....           | 15         | 11    | 17           | ma       |
| Effective Load Resistance (Plate-to-plate)..... | 6600       | 3800  | 9000         | ohms     |
| Total Harmonic Distortion.....                  | 2          | 2     | 4            | per cent |
| Maximum-Signal Power Output.....                | 26.5       | 18    | 24.5         | watts    |

## Maximum Ratings: PUSH-PULL CLASS AB<sub>2</sub> AMPLIFIER

(Same as for single-tube class A<sub>1</sub> amplifier)

### Typical Operation (Values are for two tubes):

|   | Fixed Bias |       |          |
|---|------------|-------|----------|
| Plate Voltage.....                              | 360        | 360   | volts    |
| Grid-No.2 Voltage.....                          | 225        | 270   | volts    |
| Grid-No.1 (Control-Grid) Voltage.....           | -18        | -22.5 | volts    |
| Peak AF Grid-No.1-to-Grid-No.1 Voltage.....     | 52         | 72    | volts    |
| Zero-Signal Plate Current.....                  | 78         | 88    | ma       |
| Maximum-Signal Plate Current.....               | 142        | 205   | ma       |
| Zero-Signal Grid-No.2 Current.....              | 3.5        | 5     | ma       |
| Maximum-Signal Grid-No.2 Current.....           | 11         | 16    | ma       |
| Effective Load Resistance (Plate-to-plate)..... | 6000       | 3800  | ohms     |
| Total Harmonic Distortion.....                  | 2          | 2     | per cent |
| Maximum-Signal Power Output.....                | 31         | 47    | watts    |

### Maximum Circuit Values:

|                                 |         |        |
|---------------------------------|---------|--------|
| Grid-No.1-Circuit Resistance:   |         |        |
| For fixed-bias operation.....   | 0.1 maz | megohm |
| For cathode-bias operation..... | 0.5 maz | megohm |

## INSTALLATION AND APPLICATION

Types 6L6 and 6L6-G require an octal socket and may be mounted in any position. Outlines 7 and 42, respectively, OUTLINES SECTION. It is especially important that these tubes, like other power-handling tubes, be adequately ventilated.

The heater is designed to operate at 6.3 volts. The transformer supplying this voltage should be designed to operate the heater at this recommended value for full-load operating conditions at average line voltage. Under the maximum grid-No.2- and plate-dissipation conditions, the heater voltage should never fluctuate so that it exceeds 7.0 volts. For cathode connection, refer to type 6AQ5.

In all services, precautions should be taken to insure that the dissipation rating is not exceeded with expected line-voltage variations, especially in the cases of fixed-bias operation. When the push-pull connection is used, fixed-bias values up to 10% of each typical grid-No.2 voltage can be used without increasing distortion.

As class A<sub>1</sub> power amplifiers, the 6L6 and 6L6-G may be operated as shown in the tabulated data. The values cover cathode- and fixed-bias operation for both types where used as beam power tubes as well as where they are connected as triodes and have been determined on the basis that no grid current flows during any part of the input-signal swing. The second harmonics can easily be eliminated by the use of push-pull circuits. In single-tube amplifiers with resistance-coupled input, the second harmonics can be minimized by generating out-of-phase second harmonics in the pre-amplifier.

As push-pull class AB<sub>1</sub> power amplifiers, the 6L6 and 6L6-G may be operated as shown in the tabulated data. The values shown cover cathode- and fixed-bias operation and have been determined on the basis that no grid current flows during any part of the input-signal swing.

As push-pull class AB<sub>2</sub> power amplifiers, the 6L6 and the 6L6-G may be operated as shown in the tabulated data. The values cover operation with fixed bias and have been determined on the basis that some grid current flows during the most positive swing of the input signal.

Refer to CIRCUIT SECTION for circuits employing the 6L6 or 6L6-G, and to the ELECTRON TUBE APPLICATIONS SECTION for discussion of inverse-feedback arrangements.

AVERAGE PLATE CHARACTERISTICS  
WITH EC<sub>1</sub> AS VARIABLE

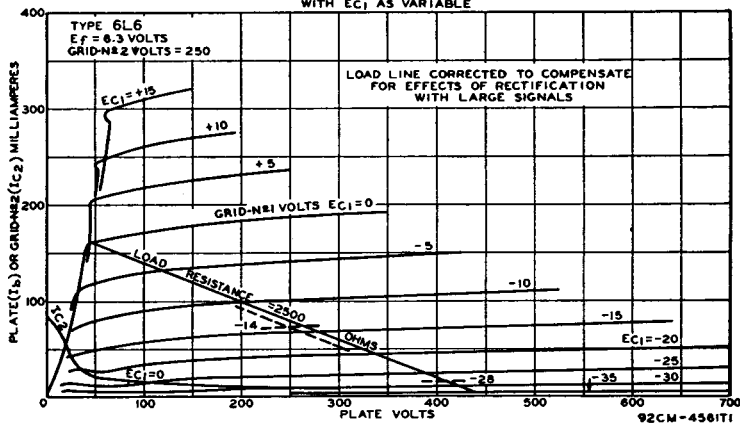

### PENTAGRID MIXER

Metal type 6L7 and glass-octal type 6L7-G are used as mixers in superheterodyne circuits having a separate oscillator stage as well as in other applications where dual control is desirable in a single stage. The two separate control grids are shielded from each other and the coupling effects between oscillator and signal circuits are very small. For additional informa-

6L7  
6L7-G

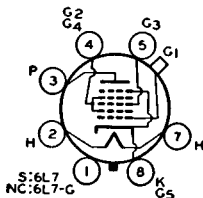

tion, refer to *Frequency Conversion*, ELECTRON TUBE APPLICATIONS SECTION. Outlines 4 and 35, respectively, OUTLINES SECTION. Type 6L7-G is a DISCONTINUED type listed for reference only. Heater volts (ac/dc), 6.3; amperes, 0.3. Maximum ratings as mixer: plate volts, 300; grids-No.2-and-No.4 volts, 150; plate dissipation, 1.0 watt; grids-No.2-and-No.4 input, 1.5 watts. Typical operation as mixer (values recommended for all-wave receivers): plate volts, 250; grids-No.2-and-No.4 volts, 150; grid-No.1 (signal-grid) volts, -6 min; grid-No.3 (oscillator-grid) volts\*, -15; peak oscillator volts applied to grid-No.3, 18 min; plate ma, 3.3; grids-No.2-and-No.4 ma, 9.2; plate resistance, greater than 1 megohm; conversion transconductance, 350  $\mu$ mhos; grid-No.1 volts for 5  $\mu$ mhos conversion transconductance, -45.

\* The dc resistance in the grid-No.3 circuit should be limited to 50000 ohms.

## 6N6-G

### DIRECT-COUPLED POWER TRIODE

Glass octal type used as class A<sub>1</sub> power amplifier. Outline 37, OUTLINES SECTION. Heater volts (ac/dc), 6.3; amperes, 0.8. For electrical characteristics, refer to type 6B5. Type 6N6-G is a DISCONTINUED type listed for reference only.

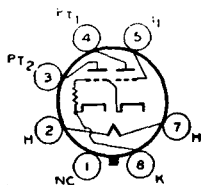

## 6N7 6N7-GT

### HIGH-MU TWIN POWER TRIODE

Metal type 6N7 and glass-octal type 6N7-GT used in output stage of radio receivers as class B power amplifier or with units in parallel as a class A<sub>1</sub> amplifier to drive a 6N7 or 6N7-GT

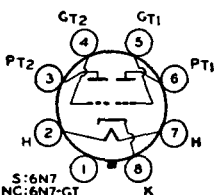

as a class B amplifier. Outlines 6 and 23, respectively, OUTLINES SECTION. Tubes require octal socket and may be mounted in any position. For typical operation as a resistance-coupled amplifier, refer to Chart 6, RESISTANCE-COUPLED AMPLIFIER SECTION. For class B amplifier considerations, refer to ELECTRON TUBE APPLICATIONS SECTION. Type 6N7 is used principally for renewal purposes.

|                             |     |        |
|-----------------------------|-----|--------|
| HEATER VOLTAGE (AC/DC)..... | 6.3 | volts  |
| HEATER CURRENT.....         | 0.8 | ampere |

### CLASS B POWER AMPLIFIER

#### Maximum Ratings (Each Unit):

|  |         |       |
|--|---------|-------|
| PLATE VOLTAGE.....                           | 300 max | volts |
| PEAK PLATE CURRENT.....                      | 125 max | ma    |
| AVERAGE PLATE DISSIPATION.....               | 5.5 max | watts |
| PEAK HEATER-CATHODE VOLTAGE:                 |         |       |
| Heater negative with respect to cathode..... | 90 max  | volts |
| Heater positive with respect to cathode..... | 90 max  | volts |

#### Typical Operation (Both Units):

|   |      |       |          |
|---|------|-------|----------|
| Plate-Supply Impedance.....                     | 0    | 1000  | ohms     |
| Effective Grid-Circuit Impedance.....           | 0    | 516** | ohms     |
| Plate Voltage.....                              | 300  | 300   | volts    |
| Grid Voltage.....                               | 0    | 0     | volts    |
| Peak AF Grid-to-Grid Voltage.....               | 58   | 82    | volts    |
| Zero-Signal DC Plate Current.....               | 35   | 35    | ma       |
| Maximum-Signal DC Plate Current.....            | 70   | 70    | ma       |
| Peak Grid Current (Each Unit).....              | 20   | 22    | ma       |
| Effective Load Resistance (Plate-to-plate)..... | 8000 | 8000  | ohms     |
| Total Harmonic Distortion.....                  | 4    | 8     | per cent |
| Maximum-Signal Power Output.....                | 10   | 10    | watts    |

\*\* At 400 cycles per second for class B stage in which the effective resistance per grid circuit is 500 ohms, and the leakage reactance of the coupling transformer is 50 millihenries. The driver stage should be capable of supplying the grids of the class B stage with the specified values at low distortion.

### CLASS A<sub>1</sub> AMPLIFIER

Both grids connected together at socket; likewise, both plates.

#### Maximum Ratings:

|                                    |         |       |
|------------------------------------|---------|-------|
| PLATE VOLTAGE.....                 | 300 max | volts |
| PLATE DISSIPATION (per plate)..... | 1.0 max | watt  |



**PEAK HEATER-CATHODE VOLTAGE:**

|  |        |       |
|--|--------|-------|
| Heater negative with respect to cathode..... | 90 max | volts |
| Heater positive with respect to cathode..... | 90 max | volts |

**Typical Operation:**

|                           |       |       |            |
|---------------------------|-------|-------|------------|
| Plate Voltage.....        | 250   | 300   | volts      |
| Grid Voltage.....         | -5    | -6    | volts      |
| Amplification Factor..... | 35    | 35    |            |
| Plate Resistance.....     | 11300 | 11000 | ohms       |
| Transconductance.....     | 3100  | 3200  | $\mu$ mhos |
| Plate Current.....        | 6     | 7     | ma         |

Plate Load—Depends largely on the design factors of the class B amplifier. In general, the load will be between 20000 and 40000 ohms.

Power Output—Under maximum voltage conditions, upwards of 400 milliwatts can be obtained.

## MEDIUM-MU TRIODE

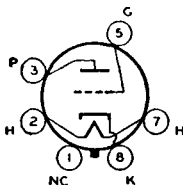

Glass octal type used as detector, amplifier, or oscillator in radio receivers. Outline 23, OUTLINES SECTION. This type may be supplied with pin No.1 omitted. Tube requires octal socket. Heater volts (ac/dc), 6.3; amperes, 0.3. Except for interelectrode capacitances, this type is identical electrically with type 76. Type 6P5-GT is a DISCONTINUED type listed for reference only.

6P5-GT

## TRIODE—PENTODE

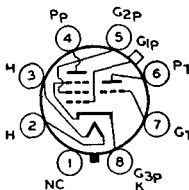

Glass octal type used as an amplifier. Outline 35, OUTLINES SECTION. Heater volts (ac/dc), 6.3; amperes, 0.3. Except for interelectrode capacitances, this type is identical electrically with type 6F7. Type 6P7-G is a DISCONTINUED type listed for reference only.

6P7-G

## TWIN DIODE—HIGH-MU TRIODE

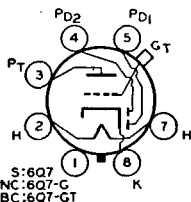

S:6Q7  
NC:6Q7-G  
BC:6Q7-GT

Metal type 6Q7 and glass-octal types 6Q7-G and 6Q7-GT used as combined detector, amplifier, and avc tubes in radio receivers. Outlines 4, 35, and 24, respectively, OUTLINES SECTION. Types 6Q7 and 6Q7-GT are used principally for renewal purposes. Type 6Q7-G is a DISCONTINUED type listed for reference only. Tubes require octal socket and may be mounted in any position Heater volts (ac/dc),

6Q7  
6Q7-G  
6Q7-GT

6.3; amperes, 0.3. For heater and cathode considerations, refer to type 6AV6. These types are similar electrically in most respects to types 6SQ7 and 6AT6. Maximum ratings and typical operation of the triode unit as a class A<sub>1</sub> amplifier are the same as those for type 6AT6 except that with a plate voltage of 100 volts, the transconductance is 1200  $\mu$ mhos and the plate resistance 58000 ohms. The triode unit is recommended for use only in resistance-coupled circuits; refer to Chart 7, RESISTANCE-COUPLED AMPLIFIER SECTION. For triode-unit, grid-bias considerations and diode curves, refer to type 6AV6.

## TWIN DIODE—MEDIUM-MU TRIODE

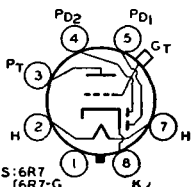

S:6R7  
NC:6R7-G  
BC:6R7-GT

Metal type 6R7 and glass-octal types 6R7-G and 6R7-GT used as combined detector, amplifier, and avc tubes. Outlines 4, 35, and 21, respectively, OUTLINES SECTION. Type 6R7-GT may be supplied with pin No.1 omitted. Tubes require octal sockets. Within their maximum ratings, these types are identical electrically with type 6BF6 except for capacitances. Maximum ratings of triode unit as class

6R7  
6R7-G  
6R7-GT

A<sub>1</sub> amplifier: plate volts, 250 max; plate dissipation, 2.5 max watts. For typical operation as a resistance-coupled amplifier, refer to Chart 9, RESISTANCE-COUPLED AMPLIFIER SECTION. Types 6R7-G and 6R7-GT are DISCONTINUED types listed for reference only. Type 6R7 is used principally for renewal purposes.

# 6S4

## MEDIUM-MU TRIODE

Miniature type having high performance used as vertical deflection amplifier in television receivers. Outline 17, OUTLINES SECTION. Tube requires noval nine-contact socket and may be

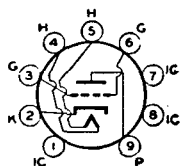

mounted in any position. For heater and cathode considerations, refer to type 6AQ5.

|                             |     |        |
|-----------------------------|-----|--------|
| HEATER VOLTAGE (AC/DC)..... | 6.3 | volts  |
| HEATER CURRENT.....         | 0.6 | ampere |

|                                 |                                      |       |
|---------------------------------|--------------------------------------|-------|
| <b>Characteristics:</b>         | <b>CLASS A<sub>1</sub> AMPLIFIER</b> |       |
| Plate Voltage.....              | 250                                  | volts |
| Grid Voltage.....               | -8                                   | volts |
| Amplification Factor.....       | 16                                   |       |
| Plate Resistance (Approx.)..... | 3600                                 | ohms  |
| Transconductance.....           | 4500                                 | μmhos |
| Plate Current.....              | 26                                   | ma    |

### VERTICAL DEFLECTION AMPLIFIER

For operation in a 525-line, 30-frame system

|  |           |       |
|--|-----------|-------|
| <b>Maximum Ratings:</b>                                    |           |       |
| DC PLATE VOLTAGE.....                                      | 500 max   | volts |
| PEAK POSITIVE-PULSE PLATE VOLTAGE† (Absolute maximum)..... | 2200° max | volts |
| PEAK NEGATIVE-PULSE GRID VOLTAGE.....                      | -250 max  | volts |
| <b>CATHODE CURRENT:</b>                                    |           |       |
| Peak.....  | 105 max   | ma    |
| DC.....  | 30 max    | ma    |
| <b>PLATE DISSIPATION.....</b>                              | 7.5 max   | watts |
| <b>PEAK HEATER-CATHODE VOLTAGE:</b>                        |           |       |
| Heater negative with respect to cathode.....               | 200 max   | volts |
| Heater positive with respect to cathode.....               | 200° max  | volts |

### Maximum Circuit Values:

|                                 |                 |
|---------------------------------|-----------------|
| <b>Grid-Circuit Resistance:</b> |                 |
| For cathode-bias operation..... | 2.2 max megohms |

† The duration of the voltage pulse must not exceed 15 per cent of one vertical scanning cycle. In a 525-line, 30-frame system, 15 per cent of one vertical scanning cycle is 2.5 milliseconds.

° Under no circumstances should this absolute value be exceeded.

■ The dc component must not exceed 100 volts.

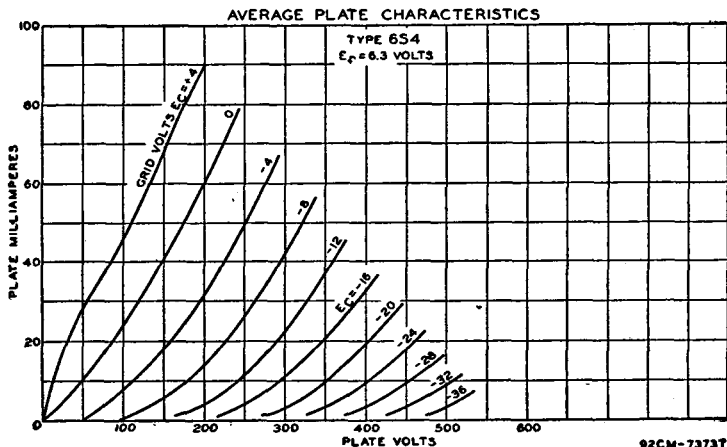

92CM-7373T

### REMOTE-CUTOFF PENTODE

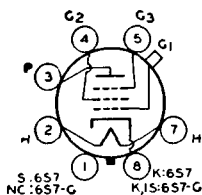

Metal type 6S7 and glass-octal type 6S7-G used in rf and if stages of automobile receivers employing avc. Outlines 5 and 35, respectively, OUTLINES SECTION. Type 6S7 is used principally for renewal purposes. Type 6S7-G is a DISCONTINUED type listed for reference only. Tubes require octal socket and may be mounted in any position. Heater volts, 6.3; amperes, 0.15. Typical operation and maximum

6S7  
6S7-G

ratings as Class A<sub>1</sub> amplifier: plate volts, 250 (300 max); grid-No.2 volts, see curve page 64; grid-No.<sub>2</sub> supply volts, 300 max; grid-No.1 volts, -3 (0 min); grid No.3 connected to cathode at socket; late ma., 8.5; grid-No.2 ma., 2; plate resistance, 1.0 megohm; transconductance, 1750 μmhos; grid-No.1 volts for transconductance of 10 μmhos, -38. Plate dissipation, 2.25 max watts; grid-No.2 input: for grid-No.2 voltages up to 150 volts, 0.25 max watt; for grid-No.2 voltages between 150 and 300 volts, see curve page 64. For typical operation as a resistance-coupled amplifier, refer to Chart 15, RESISTANCE-COUPLED AMPLIFIER SECTION.

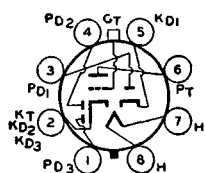

### TRIPLE DIODE—HIGH-MU TRIODE

Glass octal type used as audio amplifier, AM detector, and FM detector in AM/FM receivers. Diode unit No.2 is used for AM detection, and diode units No.1 and No.3 are used for FM detection. The grid of the high-mu triode is brought out to a top cap. Outline 28-OUTLINES SECTION. Tube requires octal socket and may be mounted in any position. For

6S8-GT

heater and cathode considerations, refer to type 6AV6. For typical operation of triode unit as a resistance-coupled amplifier, refer to Chart 4, RESISTANCE-COUPLED AMPLIFIER SECTION. Type 6S8-GT is used principally for renewal purposes.

|   |           |        |
|---|-----------|--------|
| HEATER VOLTAGE (AC/DC) .....                                    | 6.3       | volts  |
| HEATER CURRENT .....  | 0.3       | ampere |
| DIRECT INTERELECTRODE CAPACITANCES (With external shield):      |           |        |
| Triode Unit:  |           |        |
| Grid to Plate .....   | 1.2       | μμf    |
| Grid to Cathode and Heater .....                                | 2.0       | μμf    |
| Plate to Cathode and Heater .....                               | 5.0       | μμf    |
| Triode Grid to any Diode Plate .....                            | 0.005 max | μμf    |
| Diode Plate to Cathode and Heater (Approx. for each unit) ..... | 1.0       | μμf    |

**Maximum Ratings:**

#### TRIODE UNIT AS CLASS A<sub>1</sub> AMPLIFIER

|   |         |       |
|---|---------|-------|
| PLATE VOLTAGE .....                           | 300 max | volts |
| PLATE DISSIPATION .....                       | 0.5 max | watt  |
| PEAK HEATER-CATHODE VOLTAGE:                  |         |       |
| Heater negative with respect to cathode ..... | 90 max  | volts |
| Heater positive with respect to cathode ..... | 90 max  | volts |

**Characteristics:**

|                            |        |        |       |         |
|----------------------------|--------|--------|-------|---------|
| Plate Voltage .....        | 50     | 100    | 250   | volts   |
| Grid Voltage .....         | -      | -1     | -2    | volts   |
| Grid Resistor .....        | 10     | 0      | 0     | megohms |
| Amplification Factor ..... | 85     | 100    | 100   |         |
| Plate Resistance .....     | 285000 | 110000 | 91000 | ohms    |
| Transconductance .....     | 300    | 900    | 1100  | μmhos   |
| Plate Current .....        | 0.07   | 0.4    | 0.9   | ma      |

**Maximum Rating:**

#### DIODE UNITS

|                                 |         |    |
|---------------------------------|---------|----|
| PLATE CURRENT (EACH UNIT) ..... | 1.0 max | ma |
|---------------------------------|---------|----|

Diode units No.2 and No.3 and the triode unit have a common cathode. Diode unit No.1 has a separate cathode. For diode operation curves, refer to type 6AV6.

**PENTAGRID CONVERTER**

Metal type 6SA7 and glass-octal type 6SA7-GT used as converters in superheterodyne circuits. They are similar in performance to type 6BE6. For general discussion of pentagrid types, see *Frequency Conversion* in ELECTRON TUBE APPLICATIONS SECTION. Both tubes have excellent frequency stability. Type 6SA7-GT is used principally for renewal purposes.

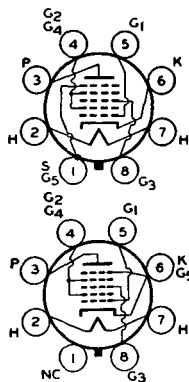

**6SA7**

**6SA7-GT**

|                                  |     |        |
|----------------------------------|-----|--------|
| HEATER VOLTAGE (AC/DC) . . . . . | 6.3 | volts  |
| HEATER CURRENT . . . . .         | 0.3 | ampere |

**DIRECT INTERELECTRODE CAPACITANCES:**

|  | 6SA7      | 6SA7-GT   |                  |
|--|-----------|-----------|------------------|
| Grid No.3 to All Other Electrodes (RF Input) . . . . .                           | 9.5*      | 9.5**     | $\mu\mu\text{f}$ |
| Plate to All Other Electrodes (Mixer Output) . . . . .                           | 9.5*      | 9.5**     | $\mu\mu\text{f}$ |
| Grid No.1 to All Other Electrodes (Osc. Input) . . . . .                         | 7*        | 8**       | $\mu\mu\text{f}$ |
| Grid No.3 to Plate . . . . .   | 0.25 max* | 0.5 max** | $\mu\mu\text{f}$ |
| Grid No.3 to Grid No.1 . . . . .   | 0.15 max* | 0.4 max** | $\mu\mu\text{f}$ |
| Grid No.1 to Plate . . . . .   | 0.06 max* | 0.2 max** | $\mu\mu\text{f}$ |
| Grid No.1 to Shell, Grid No.5, and All Other Electrodes except Cathode . . . . . | 4.4       | -         | $\mu\mu\text{f}$ |
| Grid No.1 to All Other Electrodes except Cathode and Grid No.5 . . . . .         | -         | 5         | $\mu\mu\text{f}$ |
| Grid No.1 to Cathode . . . . .   | 2.6       | -         | $\mu\mu\text{f}$ |
| Grid No.1 to Cathode and Grid No.5 . . . . .                                     | -         | 8         | $\mu\mu\text{f}$ |
| Cathode to Shell, Grid No.5, and All Other Electrodes except Grid No.1 . . . . . | 5         | -         | $\mu\mu\text{f}$ |
| Cathode and Grid No.5 to All Other Electrodes except Grid No.1 . . . . .         | -         | 14        | $\mu\mu\text{f}$ |

\* With shell connected to cathode. \*\* With external shield connected to cathode.

**Maximum Ratings:**

**CONVERTER SERVICE**

|   |         |       |
|---|---------|-------|
| PLATE VOLTAGE . . . . .                           | 300 max | volts |
| GRIDS-NO.2-AND-NO.4 VOLTAGE . . . . .             | 100 max | volts |
| GRIDS-NO.2-AND-NO.4 SUPPLY VOLTAGE . . . . .      | 300 max | volts |
| GRID-NO.3 VOLTAGE:                                |         |       |
| Negative bias value . . . . .                     | -50 max | volts |
| Positive bias value . . . . .                     | 0 max   | volts |
| PLATE DISSIPATION . . . . .                       | 1.0 max | watt  |
| GRIDS-NO.2-AND-NO.4 INPUT . . . . .               | 1.0 max | watt  |
| TOTAL CATHODE CURRENT . . . . .                   | 14 max  | ma    |
| PEAK HEATER-CATHODE VOLTAGE:                      |         |       |
| Heater negative with respect to cathode . . . . . | 90 max  | volts |
| Heater positive with respect to cathode . . . . . | 90 max  | volts |

**Typical Operation:**

|   | Self-Excitation† |       | Separate Excitation |       |                  |
|---|------------------|-------|---------------------|-------|------------------|
|   |                  |       |                     |       |                  |
| Plate Voltage . . . . .   | 100              | 250   | 100                 | 250   | volts            |
| Grids-No.2-and-No.4 Voltage . . . . .   | 100              | 100   | 100                 | 100   | volts            |
| Grid-No.3 (Control-Grid) Voltage . . . . .  | 0                | 0     | -2                  | -2    | volts            |
| Grid-No.1 Resistor . . . . .  | 20000            | 20000 | 20000               | 20000 | ohms             |
| Plate Resistance (Approx.) . . . . .  | 0.5              | 1.0   | 0.5                 | 1.0   | megohm           |
| Conversion Transconductance . . . . .   | 425              | 450   | 425                 | 450   | $\mu\text{mhos}$ |
| Grid-No.3 Voltage (Approx.)   |                  |       |                     |       |                  |
| for transconductance of 10 $\mu\text{mhos}$ . . . . .   | -25              | -25   | -25                 | -25   | volts            |
| Grid-No.3 Voltage (Approx.) for conversion transconductance of 100 $\mu\text{mhos}$ . . . . . | -9               | -9    | -9                  | -9    | volts            |
| Plate Current . . . . .   | 3.3              | 3.5   | 3.3                 | 3.5   | ma               |
| Grids-No.2-and-No.4 Current . . . . .   | 8.5              | 8.5   | 8.5                 | 8.5   | ma               |
| Grid-No.1 Current . . . . .   | 0.5              | 0.5   | 0.5                 | 0.5   | ma               |
| Total Cathode Current . . . . .   | 12.3             | 12.5  | 12.3                | 12.5  | ma               |

NOTE: The transconductance between grid No.1 and grids No.2 and No.4 connected to plate (not oscillating) is approximately 4500  $\mu\text{mhos}$  under the following conditions: grids No.1, No.3, and shell at 0 volts; grids No.2 and No.4 and plate at 100 volts.

† Characteristics are approximate only and are shown for a Hartley circuit with a feedback of approximately 2 volts peak in the cathode circuit.

## INSTALLATION AND APPLICATION

Types 6SA7 and 6SA7-GT require octal socket and may be mounted in any position. Outlines 3 and 23, respectively, OUTLINES SECTION. For heater and cathode considerations, refer to type 6AV6.

Because of the special structural arrangement of the 6SA7 and 6SA7-GT, a change in signal-grid voltage produces little change in cathode current. Consequently, an rf voltage on the signal grid produces little modulation of the electron current flowing in the cathode circuit. This feature is important because it is desirable that the impedance in the cathode circuit should produce little degeneration or regeneration of the signal-frequency input and intermediate-frequency output. Another important feature is that, because signal-grid voltage has little effect on the space charge near the cathode, changes in avc bias produce little change in oscillator transconductance and in the input capacitance of the No.1 grid. There is, therefore, little detuning of the oscillator by avc bias.

A typical self-excited oscillator circuit for use with the 6SA7 will be similar to that for the 6BE6 in the CIRCUIT SECTION. For operation in frequency bands lower than approximately 6 megacycles per second, the circuit should generally be adjusted to provide, with recommended values of plate and grids-No.2-and-No.4 voltage, a cathode voltage of approximately 2 volts peak, and a grid-No.1 current of 0.5 milliampere through a grid resistor of 20000 ohms. In the low- and medium-frequency bands, the recommended oscillator conditions can be readily met. However, in the band covering frequencies higher than approximately 6 megacycles per second, the tank-circuit impedance is generally so low that it is not easy to obtain these oscillator conditions. For optimum performance in this band, it is generally best to adjust the oscillator circuit for maximum conversion gain at the low-frequency end of the band. Maximum conversion gain at this end of the band is usually obtained by adjustment of the oscillator circuit to give a cathode voltage of approximately 2 volts peak and a grid-No.1 current of 0.20 to 0.25 milliampere, with a grid resistor of 20000 ohms.

In the 6SA7 and 6SA7-GT operation characteristics curves with self-excitation,  $E_k$  is the voltage across the oscillator-coil section between cathode and ground;  $E_g$  is the oscillator voltage between cathode and grid.

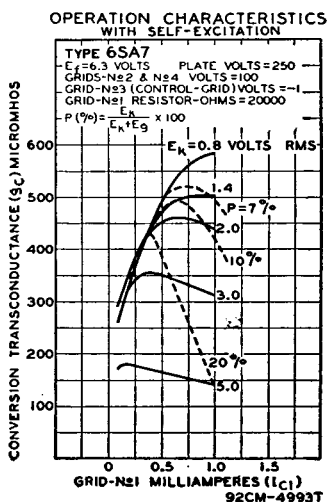
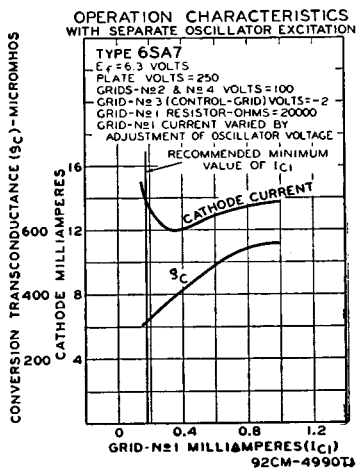

**PENTAGRID CONVERTER**

**6SB7-Y**

Metal type used as converter in super-heterodyne circuits. Because of its high conversion and oscillator transconductance, it is especially useful in FM converter service in the 100-megacycle region. The 6SB7-Y has a micanol base which minimizes drift in oscillator frequency during warm-up period. For general discussion of pentagrid types, see *Frequency Conversion* in ELECTRON TUBE APPLICATIONS SECTION. Outline 3, OUTLINES SECTION. Tube requires octal socket and may be mounted in any position. For heater and cathode considerations, refer to type 6AV6. Type 6SB7-Y is used principally for renewal purposes.

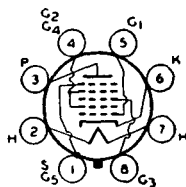

|                              |     |        |
|------------------------------|-----|--------|
| HEATER VOLTAGE (AC/DC) ..... | 6.3 | volts  |
| HEATER CURRENT .....         | 0.3 | ampere |

**CONVERTER SERVICE**

**Maximum Ratings:**

|   |                |       |
|---|----------------|-------|
| PLATE VOLTAGE .....                           | 300 <i>max</i> | volts |
| GRIDS-NO.2-AND-NO.4 VOLTAGE .....             | 100 <i>max</i> | volts |
| GRIDS-NO.2-AND-NO.4 SUPPLY VOLTAGE .....      | 300 <i>max</i> | volts |
| PLATE DISSIPATION .....                       | 2.0 <i>max</i> | watts |
| GRIDS-NO.2-AND-NO.4 INPUT .....               | 1.5 <i>max</i> | watts |
| TOTAL CATHODE CURRENT .....                   | 22 <i>max</i>  | ma    |
| GRID-NO.3 VOLTAGE:                            |                |       |
| Negative bias voltage .....                   | 100 <i>max</i> | volts |
| Positive bias voltage .....                   | 0 <i>max</i>   | volts |
| PEAK HEATER-CATHODE VOLTAGE:                  |                |       |
| Heater negative with respect to cathode ..... | 90 <i>max</i>  | volts |
| Heater positive with respect to cathode ..... | 90 <i>max</i>  | volts |

**Typical Operation (Separate Excitation):\***

|   |      |      |        |
|---|------|------|--------|
| Plate Voltage .....   | 100  | 250  | volts  |
| Grids-No.2-and-No.4 (Screen) Voltage .....                            | 100  | 100  | volts  |
| Grid-No.3 (Control-Grid) Voltage .....                                | -1.0 | -1.0 | volt   |
| Grid-No.1 (Oscillator Grid) Resistor .....                            | 2000 | 2000 | ohms   |
| Plate Resistance (Approx.) .....                                      | 0.5  | 1.0  | megohm |
| Conversion Transconductance .....                                     | 900  | 950  | μmhos  |
| Conversion Transconductance with grid-No.3 bias<br>of -20 volts ..... | 3.5  | 3.5  | μmhos  |
| Plate Current .....   | 3.6  | 3.8  | ma     |
| Grids-No.2-and-No.4 Current .....                                     | 10.2 | 10   | ma     |
| Grid-No.1 Current .....   | 0.35 | 0.35 | ma     |
| Total Cathode Current .....   | 14.2 | 14.2 | ma     |

\* The characteristics shown with separate excitation correspond very closely with those obtained in a self-excited oscillator circuit operating with zero bias.

**Typical Operation in FM Band (88-108 Mc):**

|  |       |       |    |
|--|-------|-------|----|
| Plate Voltage .....                      | 250   | volts |    |
| Grids-No.2-and-No.4 Supply Voltage ..... | 250   | volts |    |
| Grids-No.2-and-No.4 Resistor .....       | 12000 | ohms  |    |
| Grid-No.1 Resistor .....                 | 22000 | ohms  |    |
| Signal Frequency .....                   | 88    | Mc    |    |
| Oscillation Frequency .....              | 98.7  | 118.7 | Mc |
| Plate Current .....                      | 6.8   | 6.5   | ma |
| Grids-No.2-and-No.4 Current .....        | 12.6  | 12.5  | ma |
| Grid-No.1 Current .....                  | 0.130 | 0.140 | ma |

NOTE: The transconductance between grid No.1 and grids No.2 and No.4 connected to plate (not oscillating) is approximately 8000 μmhos under the following conditions: signal applied to grid No.1 at zero bias; grids No.2 and No.4 and plate at 100 volts; grid No.3 grounded. Under the same conditions, the plate current is 32 milliamperes and the amplification factor is 16.5.

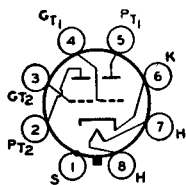

### HIGH-MU TWIN TRIODE

Metal type used as phase inverter or voltage amplifier in radio equipment. Except for common cathode, each triode is independent of the other. Outline 3, OUTLINES SECTION.

# 6SC7

Tube requires octal socket and may be mounted in any position. For heater and cathode considerations, refer to type 6AV6. For typical operation as a resistance-coupled amplifier, refer to Chart 16, RESISTANCE-COUPLED AMPLIFIER SECTION.

|  |     |               |
|--|-----|---------------|
| HEATER VOLTAGE (AC/DC) .....                             | 6.3 | volts         |
| HEATER CURRENT .....                                     | 0.3 | ampere        |
| DIRECT INTERELECTRODE CAPACITANCES (Each Unit, Approx.): |     |               |
| Grid to Plate .....                                      | 2   | $\mu\text{f}$ |
| Grid to Cathode, Heater, and Shell .....                 | 2   | $\mu\text{f}$ |
| Plate to Cathode, Heater, and Shell .....                | 3   | $\mu\text{f}$ |

|   |                                      |       |
|---|--------------------------------------|-------|
| <b>Maximum Ratings:</b>                       | <b>CLASS A<sub>1</sub> AMPLIFIER</b> |       |
| PLATE VOLTAGE .....                           | 250 max                              | volts |
| PEAK HEATER-CATHODE VOLTAGE:                  |                                      |       |
| Heater negative with respect to cathode ..... | 90 max                               | volts |
| Heater positive with respect to cathode ..... | 90 max                               | volts |

|                                       |       |                  |
|---------------------------------------|-------|------------------|
| <b>Typical Operation (Each Unit):</b> |       |                  |
| Plate Voltage .....                   | 250   | volts            |
| Grid Voltage .....                    | -2    | volts            |
| Amplification Factor .....            | 70    |                  |
| Plate Resistance (Approx.) .....      | 53000 | ohms             |
| Transconductance (Approx.) .....      | 1325  | $\mu\text{mhos}$ |
| Plate Current .....                   | 2     | ma               |

AVERAGE PLATE CHARACTERISTICS  
EACH TRIODE UNIT

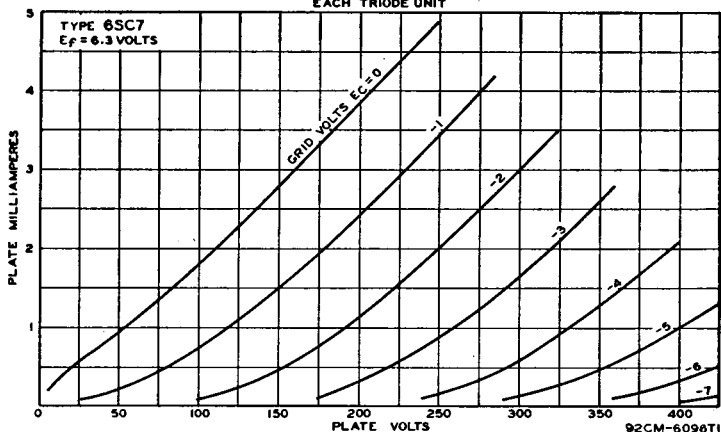

### HIGH-MU TRIODE

Metal type 6SF5 and glass-octal type 6SF5-GT are used in resistance-coupled amplifier circuits. Outlines 3 and 23, respectively, OUTLINES SECTION. Type 6SF5-GT may be supplied with pin No.1 omitted. Tubes require octal socket and may be mounted in any position. Characteristics, application, and references under type 6F5 apply to types 6SF5 and 6SF5-GT. Heater volts (ac/dc), 6.3; amperes, 0.3. Type 6SF5-GT is used principally for renewal purposes.

# 6SF5 6SF5-GT

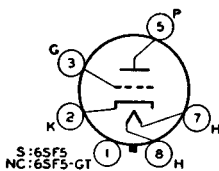

**DIODE—REMOTE-CUTOFF PENTODE**

**6SF7**

Metal type used as combined rf or if amplifier and detector or avc tube in radio receivers. Also used as resistance-coupled amplifier. Outline 3, OUTLINES SECTION. Tube requires octal socket and may be mounted in any position. For heater and cathode considerations, refer to type 6AV6. For typical operation as a resistance-coupled amplifier, refer to Chart 18,

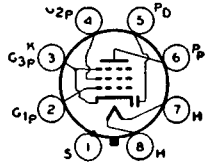

**RESISTANCE-COUPLED AMPLIFIER SECTION.** This type is used principally for renewal purposes.

|                              |     |        |
|------------------------------|-----|--------|
| HEATER VOLTAGE (AC/DC) ..... | 6.3 | volts  |
| HEATER CURRENT .....         | 0.3 | ampere |

**Maximum Ratings: PENTODE UNIT AS CLASS A<sub>1</sub> AMPLIFIER**

|   |         |       |
|---|---------|-------|
| PLATE VOLTAGE .....   | 300 max | volts |
| GRID-NO.2 (SCREEN) VOLTAGE .....                            | 100 max | volts |
| GRID-NO.2 SUPPLY VOLTAGE .....                              | 300 max | volts |
| GRID-NO.1 (CONTROL-GRID) VOLTAGE, Positive Bias Value ..... | 0 max   | volts |
| PLATE DISSIPATION .....                                     | 3.5 max | watts |
| GRID-NO.2 INPUT .....                                       | 0.5 max | watt  |
| PEAK HEATER-CATHODE VOLTAGE:                                |         |       |
| Heater negative with respect to cathode .....               | 90 max  | volts |
| Heater positive with respect to cathode .....               | 90 max  | volts |

**Typical Operation:**

|   |      |      |        |
|---|------|------|--------|
| Plate Voltage .....   | 100  | 250  | volts  |
| Grid-No.2 Voltage .....   | 100  | 100  | volts  |
| Grid-No.1 Voltage .....   | -1   | -1   | volt   |
| Plate Resistance (Approx.) .....                                | 0.2  | 0.7  | megohm |
| Transconductance .....  | 1975 | 2050 | μmhos  |
| Grid-No.1 Bias (Approx.) for transconductance of 10 μmhos ..... | -35  | -35  | volts  |
| Plate Current .....   | 13.5 | 13.9 | ma     |
| Grid-No. 2 Current .....  | 4.3  | 4.1  | ma     |

**DIODE UNIT**

The diode plate is placed around the cathode, the sleeve of which is common to the pentode unit. For diode operation curves, refer to type 6AV6.

**REMOTE-CUTOFF PENTODE**

**6SG7**

Metal type used as rf amplifier in high-frequency and wide-band applications. Features high transconductance with low grid-No.1-to-plate capacitance. Suitable for frequencies

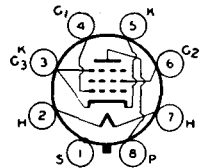

up to 18 megacycles per second (approx.). Two separate cathode terminals enable the input and output circuits to be effectively isolated from each other. Outline 3, OUTLINES SECTION. Tube requires octal socket and may be mounted in any position. For heater and cathode considerations, refer to type 6AV6.

|   |           |        |
|---|-----------|--------|
| HEATER VOLTAGE (AC/DC) .....  | 6.3       | volts  |
| HEATER CURRENT .....  | 0.3       | ampere |
| DIRECT INTERELECTRODE CAPACITANCES:                                 |           |        |
| Grid No.1 to Plate .....  | 0.003 max | μf     |
| Grid No.1 to Cathode, Heater, Grid No.2, Grid No.3, and Shell ..... | 8.5       | μf     |
| Plate to Cathode, Heater, Grid No.2, Grid No.3, and Shell .....     | 7.0       | μf     |

**Maximum Ratings: CLASS A<sub>1</sub> AMPLIFIER**

|   |                   |       |
|---|-------------------|-------|
| PLATE VOLTAGE .....   | 300 max           | volts |
| GRID-NO.2 (SCREEN) VOLTAGE .....                            | See curve page 64 |       |
| GRID-NO.2 SUPPLY VOLTAGE .....                              | 300 max           | volts |
| GRID-NO.1 (CONTROL-GRID) VOLTAGE, Positive Bias Value ..... | 0 max             | volts |
| PLATE DISSIPATION .....                                     | 3 max             | watts |
| GRID-NO.2 INPUT:  |                   |       |
| For grid-No.2 voltages up to 150 volts .....                | 0.6 max           | watt  |
| For grid-No.2 voltages between 150 and 300 volts .....      | See curve page 64 |       |
| PEAK HEATER-CATHODE VOLTAGE:                                |                   |       |
| Heater negative with respect to cathode .....               | 90 max            | volts |
| Heater positive with respect to cathode .....               | 90 max            | volts |



**Typical Operation:**

|   |       |      |       |            |
|---|-------|------|-------|------------|
| Plate Voltage.....  | 100   | 250  | 250   | volts      |
| Grid-No.2 Voltage.....  | 100   | 125  | 150   | volts      |
| Grid-No.1 Voltage.....  | -1    | -1   | -2.5  | volts      |
| Plate Resistance (Approx.).....                                     | 0.25  | 0.9  | *     | megohm     |
| Transconductance.....   | 4100  | 4700 | 4000  | $\mu$ mhos |
| Grid-No.1 Bias (Approx.) for transconductance of 40 $\mu$ mhos..... | -11.5 | -14  | -17.5 | volts      |
| Plate Current.....  | 8.2   | 11.8 | 9.2   | ma         |
| Grid-No.2 Current.....  | 3.2   | 4.4  | 3.4   | ma         |

\* Greater than 1 megohm.

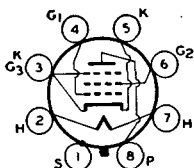

**SHARP-CUTOFF PENTODE**

Metal type used as rf amplifier in high-frequency, wide-band applications and as a limiter tube in FM equipment. Similar electrically to miniature type 6AU6. It features high

**6SH7**

transconductance and low grid-No.1-to-plate capacitance. Outline 3, **OUTLINES SECTION**. Tube requires octal socket and may be mounted in any position. Two separate cathode terminals enable the input and output circuits to be isolated effectively from each other. This type is not recommended for high-gain, audio-amplifier applications because undesirable hum may be encountered. For heater and cathode considerations, refer to type 6AV6. For typical operation as a resistance-coupled amplifier, refer to Chart 8, **RESISTANCE-COUPLED AMPLIFIER SECTION**.

|  |           |          |
|--|-----------|----------|
| HEATER VOLTAGE (AC/DC).....  | 6.3       | volts    |
| HEATER CURRENT.....  | 0.3       | ampere   |
| <b>DIRECT INTERELECTRODE CAPACITANCES:</b>                         |           |          |
| Grid No.1 to Plate.....  | 0.003 max | $\mu$ mf |
| Grid No.1 to Cathode, Heater, Grid No.2, Grid No.3, and Shell..... | 8.5       | $\mu$ mf |
| Plate to Cathode, Heater, Grid No.2, Grid No.3, and Shell.....     | 7.0       | $\mu$ mf |

**Maximum Ratings:**

**CLASS A<sub>1</sub> AMPLIFIER**

|  |                   |       |
|--|-------------------|-------|
| PLATE VOLTAGE.....   | 300 max           | volts |
| GRID NO.2 (SCREEN) VOLTAGE.....                            | See curve page 64 |       |
| GRID-NO.2 SUPPLY VOLTAGE.....                              | 300 max           | volts |
| PLATE DISSIPATION.....                                     | 3 max             | watts |
| GRID-NO.2 INPUT:   |                   |       |
| For grid-No.2 voltages up to 150 volts.....                | 0.7 max           | watt  |
| For grid-No.2 voltages between 150 and 300 volts.....      | See curve page 64 |       |
| GRID-NO.1 (CONTROL-GRID) VOLTAGE, Positive Bias Value..... | 0 max             | volts |
| <b>PEAK HEATER-CATHODE VOLTAGE:</b>                        |                   |       |
| Heater negative with respect to cathode.....               | 90 max            | volts |
| Heater positive with respect to cathode.....               | 90 max            | volts |

**Typical Operation:**

|   |      |      |            |
|---|------|------|------------|
| Plate Voltage.....                                  | 100  | 250  | volts      |
| Grid-No.2 Voltage.....                              | 100  | 150  | volts      |
| Grid-No.1 Voltage.....                              | -1   | -1   | volt       |
| Plate Resistance (Approx.).....                     | 0.35 | 0.9  | megohm     |
| Transconductance.....                               | 4000 | 4900 | $\mu$ mhos |
| Grid-No.1 Bias for plate current of 10 $\mu$ a..... | -4.0 | -5.5 | volts      |
| Plate Current.....                                  | 5.3  | 10.8 | ma         |
| Grid-No.2 Current.....                              | 2.1  | 4.1  | ma         |

**SHARP-CUTOFF PENTODE**

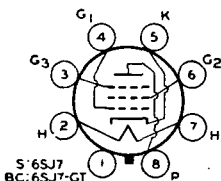

Metal type 6SJ7 and glass-octal type 6SJ7-GT are used as rf amplifiers and biased detectors. As a detector, either type is capable of delivering large audio-frequency output voltage with relatively small input voltage. Type 6SJ7-GT is used principally for renewal purposes.

**6SJ7**  
**6SJ7-GT**

|                             |     |        |
|-----------------------------|-----|--------|
| HEATER VOLTAGE (AC/DC)..... | 6.3 | volts  |
| HEATER CURRENT.....         | 0.3 | ampere |

# RCA Receiving Tube Manual

## DIRECT INTERELECTRODE CAPACITANCES:<sup>o</sup>

| Pentode Connection:                                      | 6SJ7      | 6SJ7-GT   |    |
|--|-----------|-----------|----|
| Grid No.1 to Plate.....                                  | 0.005 max | 0.005 max | μf |
| Grid No.1 to Cathode, Heater, Grid No.2, and Grid No.3.. | 6.0       | 7.0       | μf |
| Plate to Cathode, Heater, Grid No.2, and Grid No.3.....  | 7.0       | 7.0       | μf |
| Triode Connection:■                                      |           |           |    |
| Grid No.1 to Plate.....                                  | 2.8       | 2.8       | μf |
| Grid No.1 to Cathode and Heater.....                     | 3.4       | 3.4       | μf |
| Plate to Cathode and Heater.....                         | 11        | 11        | μf |

<sup>o</sup> With shell or external shield connected to cathode.

■ With grids No.2 and No.3 connected to plate.

## CLASS A<sub>1</sub> AMPLIFIER

| Maximum Ratings:  | Triode Connection | Pentode Connection |       |
|---|-------------------|--------------------|-------|
| PLATE VOLTAGE.....  | 250 max           | 300 max            | volts |
| GRID-NO.2 (SCREEN) VOLTAGE.....                           | -                 | See curve page 64  |       |
| GRID-NO.2 SUPPLY VOLTAGE.....                             | -                 | 300 max            | volts |
| GRID-NO.1 (CONTROL-GRID) VOLTAGE, Positive Bias Value.... | 0 max             | 0 max              | volts |
| PLATE DISSIPATION.....                                    | 2.5 max           | 2.5 max            | watts |
| GRID-NO.2 INPUT:  |                   |                    |       |
| For grid-No.2 voltages up to 150 volts.....               |                   | 0.7 max            | watt  |
| For grid-No.2 voltages between 150 and 300 volts.....     |                   | See curve page 64  |       |
| PEAK HEATER-CATHODE VOLTAGE:                              |                   |                    |       |
| Heater negative with respect to cathode.....              | 90 max            | 90 max             | volts |
| Heater positive with respect to cathode.....              | 90 max            | 90 max             | volts |

### Typical Operation:

|                                     | Triode Connection* |      | Pentode Connection             |      |       |
|-------------------------------------|--------------------|------|--------------------------------|------|-------|
| Plate Voltage.....                  | 180                | 250  | 100                            | 250  | volts |
| Grid-No.2 Voltage.....              | -                  | -    | 100                            | 100  | volts |
| Grid-No.1 Voltage.....              | -6                 | -8.5 | -3                             | -3   | volts |
| Grid No.3 (Suppressor).....         | -                  | -    | Connected to cathode at socket |      |       |
| Amplification Factor.....           | 19                 | 19   | -                              | -    |       |
| Plate Resistance.....               | 8250               | 7600 | 70000                          | †    | ohms  |
| Transconductance.....               | 2300               | 2500 | 1575                           | 1650 | μmhos |
| Grid-No.1 Bias for plate current of |                    |      |                                |      |       |
| 10 μA.....                          | -                  | -    | -8                             | -8   | volts |
| Plate Current.....                  | 6.0                | 9.2  | 2.9                            | 3.0  | ma    |
| Grid-No.2 Current.....              | -                  | -    | 0.9                            | 0.8  | ma    |

\* Grids No.2 and No.3 connected to plate.

† Greater than 1 megohm.

## INSTALLATION AND APPLICATION

Types 6SJ7 and 6SJ7-GT require octal socket and may be mounted in any position. Outlines 3 and 25, respectively, **OUTLINES SECTION**. For heater and cathode considerations, refer to type 6AV6.

As a class A<sub>1</sub> amplifier, the 6SJ7 or 6SJ7-GT may be operated either as a pentode or as a triode, as shown under tabulated data. The grid-No.2 voltage for the 6SJ7 operated as a pentode may be obtained from a potentiometer or bleeder circuit across the B-supply device. Due to the grid-No.2-current characteristics of the 6SJ7, a resistor in series with the high-voltage supply may be employed for obtaining the grid-No.2 voltage, provided the cathode-resistor method of bias control is used. This method, however, is not recommended if the high-voltage B-supply exceeds 300 volts.

As a radio-frequency amplifier, the 6SJ7 or 6SJ7-GT may be used particularly in applications where the rf signal applied to grid No.1 is relatively low, that is, of the order of a few volts. In such cases either grid-No.2 or grid-No.1 voltage (or both) may be varied to control the receiver volume. When larger signals are involved, a remote-cutoff amplifier tube should be employed to prevent the occurrence of excessive cross-modulation and modulation-distortion.

As an audio-frequency amplifier in resistance-coupled circuits, the 6SJ7 or 6SJ7-GT may be operated under conditions shown in Chart 19, **RESISTANCE-COUPLED AMPLIFIER SECTION**.

### AVERAGE PLATE CHARACTERISTICS

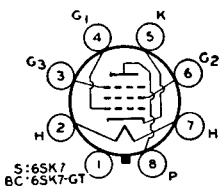
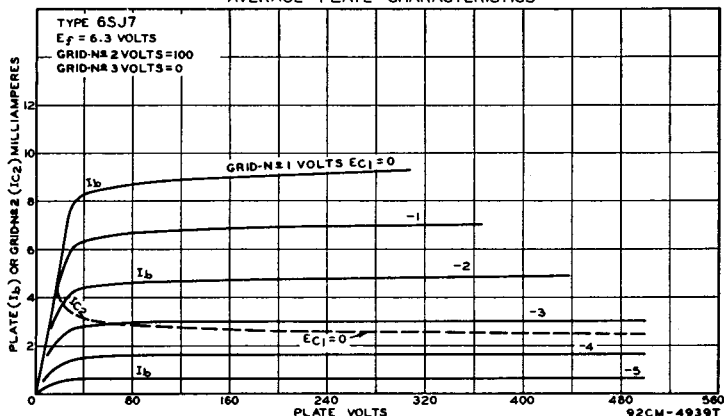

## REMOTE-CUTOFF PENTODE

Metal type 6SK7 and glass-octal type 6SK7-GT are used as rf or if amplifiers in radio receivers. They feature single-ended construction and inter-lead shields. Because of remote-cutoff

# 6SK7 6SK7-GT

characteristic, these types are able to handle large signal voltages without cross-modulation or modulation-distortion and are often used in receivers with avc. Type 6SK7-GT is used principally for renewal purposes.

|   |           |           |
|---|-----------|-----------|
| HEATER VOLTAGE (AC/DC).....                                 | 6.3       | volts     |
| HEATER CURRENT.....   | 0.3       | ampere    |
| <b>DIRECT INTERELECTRODE CAPACITANCES:</b>                  |           |           |
| Grid No.1 to Plate.....                                     | 0.003 max | 0.005 max |
| Grid No.1 to Cathode, Heater, Grid No.2, and Grid No.3..... | 6.0       | 6.5       |
| Plate to Cathode, Heater, Grid No.2, and Grid No.3.....     | 7.0       | 7.5       |

\* With shell connected to cathode.

\*\* With external shield connected to cathode.

### Maximum Ratings:

### CLASS A<sub>1</sub> AMPLIFIER

|  |                   |       |
|--|-------------------|-------|
| PLATE VOLTAGE.....   | 300 max           | volts |
| GRID-NO.2 (SCREEN) VOLTAGE.....                            | See curve page 64 |       |
| GRID-NO.2 SUPPLY VOLTAGE.....                              | 300 max           | volts |
| GRID-NO.1 (CONTROL-GRID) VOLTAGE, Positive Bias Value..... | 0 max             | volts |
| PLATE DISSIPATION.....                                     | 4.0 max           | watts |
| GRID-NO.2 INPUT:   |                   |       |
| For grid-No.2 voltages up to 150 volts.....                | 0.4 max           | watt  |
| For grid-No.2 voltages between 150 and 300 volts.....      | See curve page 64 |       |
| PEAK HEATER-CATHODE VOLTAGE:                               |                   |       |
| Heater negative with respect to cathode.....               | 90 max            | volts |
| Heater positive with respect to cathode.....               | 90 max            | volts |

### Typical Operation:

|  |                                |      |        |
|--|--------------------------------|------|--------|
| Plate Voltage.....                                   | 100                            | 250  | volts  |
| Grid-No.2 Voltage.....                               | 100                            | 100  | volts  |
| Grid-No.1 Voltage.....                               | -1                             | -3   | volts  |
| Grid No.3 (Suppressor).....                          | Connected to cathode at socket |      |        |
| Plate Resistance (Approx.).....                      | 0.12                           | 0.8  | megohm |
| Transconductance.....                                | 2350                           | 2000 | μmhos  |
| Grid-No.1 Bias for transconductance of 10 μmhos..... | -35                            | -35  | volts  |
| Plate Current.....                                   | 13                             | 9.2  | ma     |
| Grid-No.2 Current.....                               | 4.0                            | 2.6  | ma     |

### INSTALLATION AND APPLICATION

Types 6SK7 and 6SK7-GT require octal socket and may be mounted in any position. Outlines 3 and 25, respectively, OUTLINES SECTION. For heater and cathode considerations, refer to type 6AV6.

Control-grid bias variation will be found effective in changing the volume of the receiver. In order to obtain adequate volume control, an available grid-bias voltage of approximately 50 volts will be required. The exact value will depend upon the circuit design and operating conditions. This voltage may be obtained, depending on the receiver requirements, from a potentiometer across a fixed supply voltage, from a variable cathode-bias resistor, from the avc system, or from a combination of these methods.

The grid-No.2 (screen) voltage may be obtained from a potentiometer or bleeder circuit across the B-supply source, or through a dropping resistor from the plate supply. The use of series resistors for obtaining satisfactory control of grid-No.2 voltage in the case of four-electrode tubes is usually impossible because of secondary-emission phenomena. In the 6SK7, however, because grid No.3 practically removes these effects, it is possible to obtain grid-No.2 voltage through a series-dropping resistor from the plate supply or from some high intermediate voltage, provided the source does not exceed the plate-supply voltage. With this method, the grid-No.2-to-cathode voltage will fall off very little from minimum to maximum value of the resistor controlling cathode bias. In some cases, it may actually rise. This rise of grid-No.2-to-cathode voltage above the normal maximum value is allowable because both the grid-No.2 current and the plate current are reduced simultaneously by a sufficient amount to prevent damage to the tube. It should be recognized that, in general, the series-resistor method of obtaining grid-No.2 voltage from a higher voltage supply necessitates the use of the variable cathode-resistor method of controlling volume in order to prevent too high a voltage on grid No.2. When grid-No.2 and control-grid voltage are obtained in this manner, the remote "cutoff" advantage of the 6SK7 and 6SK7-GT can be fully realized. However, it should be noted that the use of a resistor in the grid-No.2 circuit will have an effect on the change in plate resistance with variation in grid-No.3 (suppressor) voltage in case grid No.3 is utilized for control purposes.

Grid No.3 (suppressor) may be connected directly to the cathode or it may be made negative with respect to the cathode. For the latter condition, the grid-No.3 voltage may be obtained from a potentiometer or bleeder circuit, or from the avc system.

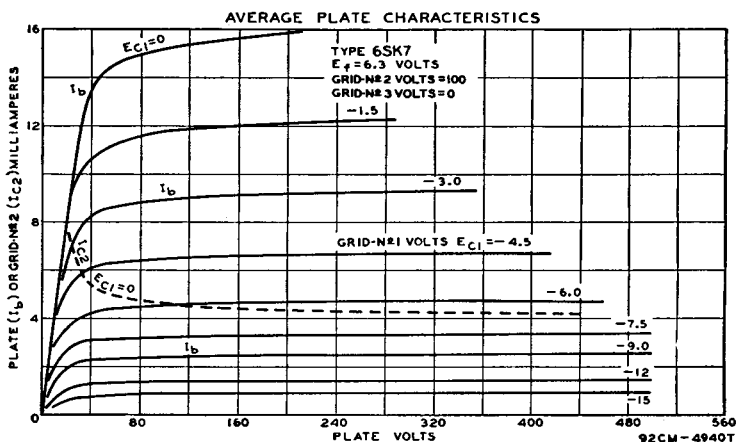

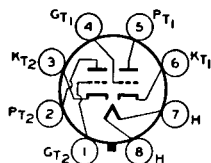

### HIGH-MU TWIN TRIODE

## 6SL7-GT

Glass octal type used as phase inverter or resistance-coupled amplifier in radio equipment. Outline 23, OUT-LINES SECTION. Tube requires octal socket and may be mounted in

any position. Except for the common heater, each triode unit is independent of the other. For typical operation as phase inverter or resistance-coupled amplifier, refer to Chart 7, RESISTANCE-COUPLED AMPLIFIER SECTION. For heater and cathode considerations, refer to type 6AV6.

|  |                   |                   |
|--|-------------------|-------------------|
| HEATER VOLTAGE (AC/DC).....                    | 6.3               | volts             |
| HEATER CURRENT.....                            | 0.3               | ampere            |
| DIRECT INTERELECTRODE CAPACITANCES (Approx.):* |                   |                   |
|  | <i>Unit No. 1</i> | <i>Unit No. 2</i> |
| Grid to Plate.....                             | 2.8               | 2.8               |
| Grid to Cathode and Heater.....                | 3.0               | 3.4               |
| Plate to Cathode and Heater.....               | 3.8               | 3.2               |

\* With close-fitting shield connected to cathode.

#### Maximum Ratings:

#### CLASS A<sub>1</sub> AMPLIFIER (Each Unit)

|  |                |       |
|--|----------------|-------|
| PLATE VOLTAGE.....                           | 300 <i>max</i> | volts |
| GRID VOLTAGE, Positive Bias Value.....       | 0 <i>max</i>   | volts |
| PLATE DISSIPATION.....                       | 1 <i>max</i>   | watt  |
| PEAK HEATER-CATHODE VOLTAGE:                 |                |       |
| Heater negative with respect to cathode..... | 90 <i>max</i>  | volts |
| Heater positive with respect to cathode..... | 90 <i>max</i>  | volts |

#### Typical Operation:

|                           |       |       |
|---------------------------|-------|-------|
| Plate Voltage.....        | 250   | volts |
| Grid Voltage.....         | -2    | volts |
| Amplification Factor..... | 70    |       |
| Plate Resistance.....     | 44000 | ohms  |
| Transconductance.....     | 1600  | μmhos |
| Plate Current.....        | 2.3   | ma    |

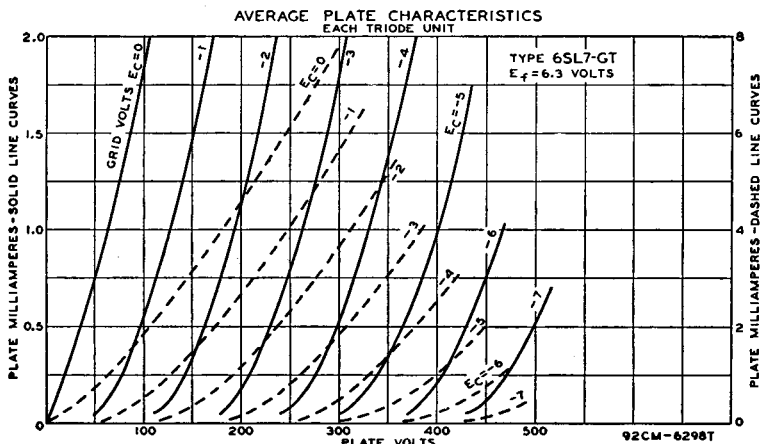

# 6SN7-GT 6SN7-GTA

## MEDIUM-MU TWIN TRIODE

Glass octal types used as combined vertical oscillator and vertical deflection amplifiers, and as horizontal deflection oscillators, in television receivers. Also used as phase inverters,

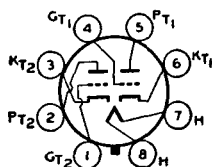

multivibrators, or resistance-coupled amplifiers in radio equipment. Outline 22, **OUTLINES SECTION**. Tubes require octal socket and may be mounted in any position. Except for the common heater, each triode unit is independent of the other. For typical operation as phase inverter or resistance-coupled amplifier, refer to Chart 13, **RESISTANCE-COUPLED AMPLIFIER SECTION**. For heater and cathode considerations, refer to type 6AQ5.

|   |     |        |
|---|-----|--------|
| HEATER VOLTAGE (AC/DC).....                   | 6.3 | volts  |
| HEATER CURRENT.....                           | 0.6 | ampere |
| DIRECT INTERELECTRODE CAPACITANCES (Approx.): |     |        |

|                                  | Unit No. 1 |          | Unit No. 2 |          |                  |
|----------------------------------|------------|----------|------------|----------|------------------|
|                                  | 6SN7-GT    | 6SN7-GTA | 6SN7-GT    | 6SN7-GTA |                  |
| Grid to Plate.....               | 3.8        | 4.0      | 4.0        | 3.8      | $\mu\mu\text{f}$ |
| Grid to Cathode and Heater.....  | 2.8        | 2.2      | 3.0        | 2.6      | $\mu\mu\text{f}$ |
| Plate to Cathode and Heater..... | 0.8        | 0.7      | 1.2        | 0.7      | $\mu\mu\text{f}$ |

### CLASS A<sub>1</sub> AMPLIFIER

Values are for Each Unit

|  | 6SN7-GT  | 6SN7-GTA |       |
|--|----------|----------|-------|
| <b>Maximum Ratings:</b>                        |          |          |       |
| PLATE VOLTAGE.....                             | 300 max  | 450 max  | volts |
| CATHODE CURRENT.....                           | 20 max   | 20 max   | ma    |
| PLATE DISSIPATION:                             |          |          |       |
| For either plate.....                          | 3.5 max  | 5 max    | watts |
| For both plates with both units operating..... | 5.0 max  | 7.5 max  | watts |
| PEAK HEATER-CATHODE VOLTAGE:                   |          |          |       |
| Heater negative with respect to cathode.....   | 200 max  | 200 max  | volts |
| Heater positive with respect to cathode.....   | 200° max | 200° max | volts |

### Characteristics:

|   |      |      |                  |
|---|------|------|------------------|
| Plate Voltage.....  | 90   | 250  | volts            |
| Grid Voltage.....   | 0    | -8   | volts            |
| Amplification Factor.....                                   | 20   | 20   |                  |
| Plate Resistance.....                                       | 6700 | 7700 | ohms             |
| Transconductance.....                                       | 3000 | 2600 | $\mu\text{mhos}$ |
| Plate Current.....  | 10   | 9    | ma               |
| Plate Current for grid voltage of -12.5 volts.....          | -    | 1.3  | ma               |
| Grid Bias Voltage (Approx.) for plate current of 10 ua..... | -7   | -18  | volts            |

### Maximum Circuit Value:

|                               |                |
|-------------------------------|----------------|
| Grid-Circuit Resistance:      |                |
| For fixed-bias operation..... | 1.0 max megohm |

° The dc component must not exceed 100 volts.

### OSCILLATOR

For operation in a 525-line, 30-frame system

|  | Vertical Deflection Oscillator | Horizontal Deflection Oscillator |         |
|--|--------------------------------|----------------------------------|---------|
| <b>Maximum Ratings (Each Unit):</b>            |                                |                                  |         |
| DC PLATE VOLTAGE.....                          | 450 • max                      | 450 • max                        | volts   |
| PEAK NEGATIVE-PULSE GRID VOLTAGE.....          | -400 # max                     | -600* max                        | volts   |
| CATHODE CURRENT:                               |                                |                                  |         |
| Peak.....                                      | 70 max                         | 300 max                          | ma      |
| Average.....                                   | 20 max                         | 20 max                           | ma      |
| PLATE DISSIPATION:                             |                                |                                  |         |
| For either plate.....                          | 5 • max                        | 5 • max                          | watts   |
| For both plates with both units operating..... | 7.5 • max                      | 7.5 • max                        | watts   |
| PEAK HEATER-CATHODE VOLTAGE:                   |                                |                                  |         |
| Heater negative with respect to cathode.....   | 200 max                        | 200 max                          | volts   |
| Heater positive with respect to cathode.....   | 200° max                       | 200° max                         | volts   |
| <b>Maximum Circuit Value:</b>                  |                                |                                  |         |
| Grid-Circuit Resistance.....                   | 2.2 max                        | 2.2 max                          | megohms |

## VERTICAL DEFLECTION AMPLIFIER

For operation in a 525-line, 30-frame system

| Maximum Ratings (Each Unit):                               | 6SN7-GT  | 6SN7-GTA |       |
|--|----------|----------|-------|
| DC PLATE VOLTAGE.....                                      | 300 max  | 450 max  | volts |
| PEAK POSITIVE-PULSE PLATE VOLTAGE # (Absolute maximum).... | 1200 max | 1500 max | volts |
| PEAK NEGATIVE-PULSE GRID VOLTAGE.....                      | -250 max | -250 max | volts |
| CATHODE CURRENT:   |          |          |       |
| Peak.....  | 70 max   | 70 max   | ma    |
| Average.....   | 20 max   | 20 max   | ma    |
| PLATE DISSIPATION:   |          |          |       |
| For either plate.....                                      | 3.5 max  | 5 max    | watts |
| For both plates with both units operating.....             | 5 max    | 7.5 max  | watts |
| PEAK HEATER-CATHODE VOLTAGE:                               |          |          |       |
| Heater negative with respect to cathode.....               | 200 max  | 200 max  | volts |
| Heater positive with respect to cathode.....               | 200 max  | 200 max  | volts |

### Maximum Circuit Value:

#### Grid-Circuit Resistance:

For cathode-bias operation..... 2.2 max megohms

# The duration of the voltage pulse must not exceed 15 per cent of one vertical scanning cycle. In a 525-line, 30-frame system, 15 per cent of one vertical scanning cycle is 2.5 milliseconds.

\* The duration of the voltage pulse must not exceed 15 per cent of one horizontal scanning cycle. In a 525-line, 30-frame system, 15 per cent of one horizontal scanning cycle is 10 milliseconds.

• For the 6SN7-GT in oscillator service, the dc plate voltage is 300 max volts, and the plate dissipation is 3.5 max watts for either plate or 5.0 max watts for both plates.

■ Under no circumstances should this absolute value be exceeded.

• The dc component must not exceed 100 volts.

**AVERAGE PLATE CHARACTERISTICS**  
EACH TRIODE UNIT

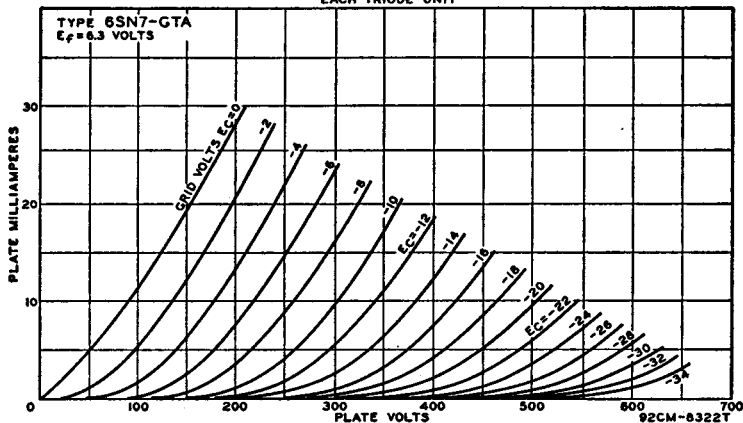

### TWIN DIODE—HIGH-MU TRIODE

Metal type 6SQ7 and glass-octal type 6SQ7-GT used as combined detector, amplifier, and avc tube in radio receivers. These types are similar electrically to type 6Q7 in many respects, but they have a higher-mu triode. Type

# 6SQ7 6SQ7-GT

6SQ7-GT is used principally for renewal purposes.

|   |       |   |
|---|-------|---|
| HEATER VOLTAGE (AC/DC).....                   | 6.3   | volts   |
| HEATER CURRENT.....                           | 0.3   | ampere  |
| DIRECT INTERELECTRODE CAPACITANCES (Approx.): | 6SQ7° | 6SQ7-GT                                       |
| Triode Unit:                                  |       |   |
| Grid to Plate.....                            | 1.6   | 1.8 <span style="float: right;">μf</span>     |
| Grid to Cathode and Heater.....               | 3.2   | 4.2 <span style="float: right;">μf</span>     |
| Plate to Cathode and Heater.....              | 3.0   | 3.4 <span style="float: right;">μf</span>     |
| Diode Plate to Cathode and Heater.....        | 0.4   | 1.8 <span style="float: right;">μf</span>     |
| Triode Grid to Plate of Diode No. 1.....      | 0.03  | 0.1 max <span style="float: right;">μf</span> |

° With shell connected to cathode.

## Maximum Ratings:

### TRIODE UNIT AS CLASS A<sub>1</sub> AMPLIFIER

|  |                |       |
|--|----------------|-------|
| PLATE VOLTAGE.....                           | 300 <i>max</i> | volts |
| GRID VOLTAGE, Positive Bias Value.....       | 0 <i>max</i>   | volts |
| PLATE DISSIPATION.....                       | 0.5 <i>max</i> | watt  |
| <b>PEAK HEATER-CATHODE VOLTAGE:</b>          |                |       |
| Heater negative with respect to cathode..... | 90 <i>max</i>  | volts |
| Heater positive with respect to cathode..... | 90 <i>max</i>  | volts |

## Characteristics:

|                           |        |       |            |
|---------------------------|--------|-------|------------|
| Plate Voltage.....        | 100    | 250   | volts      |
| Grid Voltage.....         | -1     | -2    | volts      |
| Amplification Factor..... | 100    | 100   |            |
| Plate Resistance.....     | 110000 | 85000 | ohms       |
| Transconductance.....     | 925    | 1175  | $\mu$ mhos |
| Plate Current.....        | 0.5    | 1.1   | ma         |

## Maximum Rating:

### DIODE UNITS

PLATE CURRENT (Each Unit)..... 1.0 *max* ma  
 Two diode plates are placed around a cathode, the sleeve of which is common to the triode unit. Each diode plate has its own base pin. For diode operation curves, refer to type 6AV6.

## INSTALLATION AND APPLICATION

Types 6SQ7 and 6SQ7-GT require octal socket and may be mounted in any position. Outlines 3 and 25, respectively, OUTLINES SECTION. For heater and cathode considerations, refer to type 6AV6.

The triode unit of the 6SQ7 and 6SQ7-GT is recommended for use only in resistance-coupled circuits; refer to Chart 4, RESISTANCE-COUPLED AMPLIFIER SECTION. Diode-biasing of the triode unit is not suitable because of the probability of triode plate-current cutoff even with relatively small signal voltages applied to the diode circuit.

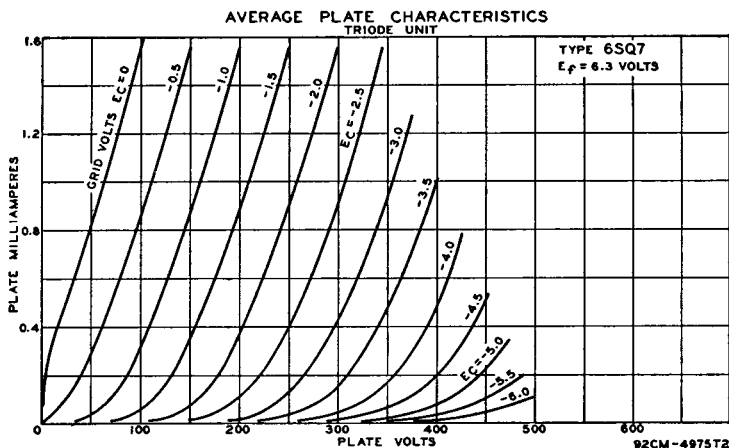

### TWIN DIODE— MEDIUM-MU TRIODE

# 6SR7

Metal type used as combined detector, amplifier, and avc tube. It is equivalent in performance to miniature type 6BF6. Outline 3, OUTLINES SECTION. Tube requires octal socket

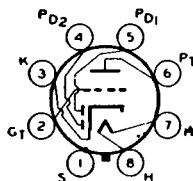

and may be mounted in any position. For typical operation as a resistance-coupled amplifier, refer to Chart 9, RESISTANCE-COUPLED AMPLIFIER SECTION. For heater and cathode considerations, refer to type 6AV6.



|  |     |               |
|--|-----|---------------|
| HEATER VOLTAGE (AC/DC).....                                      | 6.3 | volts         |
| HEATER CURRENT.....  | 0.3 | ampere        |
| <b>DIRECT INTERELECTRODE CAPACITANCES (Approx.)—Triode Unit:</b> |     |               |
| Grid to Plate.....   | 2.4 | $\mu\text{f}$ |
| Grid to Cathode, Heater, and Shell.....                          | 3.0 | $\mu\text{f}$ |
| Plate to Cathode, Heater, and Shell.....                         | 2.8 | $\mu\text{f}$ |

|   |                |   |
|---|----------------|---|
| <b>Maximum Ratings:</b>                             |                | <b>TRIODE UNIT AS CLASS A<sub>1</sub> AMPLIFIER</b> |
| PLATE VOLTAGE.....                                  | 250 <i>max</i> | volts   |
| PLATE DISSIPATION.....                              | 2.5 <i>max</i> | watts   |
| <b>PEAK HEATER-CATHODE VOLTAGE:</b>                 |                |   |
| Heater negative with respect to cathode.....        | 90 <i>max</i>  | volts   |
| Heater positive with respect to cathode.....        | 90 <i>max</i>  | volts   |
| <b>Typical Operation with Transformer Coupling:</b> |                |   |
| Plate Voltage.....                                  | 250            | volts   |
| Grid Voltage.....                                   | -9             | volts   |
| Amplification Factor.....                           | 16             |   |
| Plate Resistance.....                               | 8500           | ohms  |
| Transconductance.....                               | 1900           | $\mu\text{mhos}$                                    |
| Plate Current.....                                  | 9.5            | ma  |
| Load Resistance.....                                | 10000          | ohms  |
| Power Output.....                                   | 300            | mw  |

### DIODE UNITS

Two diode plates are placed around a cathode, the sleeve of which is common to the triode unit. Each diode plate has its own base pin. For diode operation curves, refer to type 6AV6.

### REMOTE-CUTOFF PENTODE

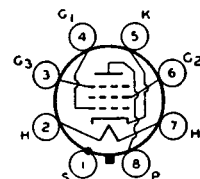

Metal type used in rf or if stages of radio receivers particularly those employing avc. Outline 3, OUTLINES SECTION. Tube requires octal socket and may be mounted in any position. For heater and cathode considerations, refer to type 6AV6. Heater volts (ac/dc), 6.3; amperes, 0.15. Typical operation and maximum ratings as class A<sub>1</sub> amplifiers: plate volts, 250 (300 *max*), grid-No.2 supply volts, 300 *max*;

## 6SS7

grid-No.2 volts, 100; grid-No.1 volts, -3; grid No.3 connected to cathode at socket; plate resistance (approx.), 1 megohm; transconductance, 1850  $\mu\text{mhos}$ ; plate ma., 9; grid-No.2 ma., 2; plate dissipation, 2.25 *max* watts; grid-No.2 input, 0.35 *max* watts. Type 6SS7 is used principally for renewal purposes.

### TWIN DIODE—MEDIUM-MU TRIODE

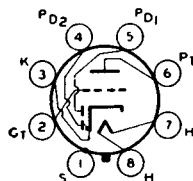

Metal type used as combined detector, amplifier, and avc tube. Within maximum ratings this type is electrically identical to type 6BF6 except for interelectrode capacitances and heater current. Outline 3, OUTLINES SECTION. Tube requires octal socket and may be mounted in any position. Heater volts (ac/dc), 6.3; amperes, 0.15. Maximum ratings of triode

## 6ST7

unit as class A<sub>1</sub> amplifier: plate volts, 250 *max*; plate dissipation, 2.5 *max* watts. For diode operation curves, refer to type 6AV6. Type 6ST7 is used principally for renewal purposes.

### TWIN DIODE—HIGH-MU TRIODE

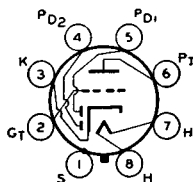

Metal type used as combined detector, amplifier, and avc tube in radio receivers. Except for heater-current rating and interelectrode capacitances, this type is essentially the same electrically as type 6AT6. Outline 3, OUTLINES SECTION. Tube requires octal socket and may be mounted in any position. Heater volts (ac/dc), 6.3; amperes, 0.15. Direct interelectrode capacitances of triode unit (shell connected to cathode):

## 6SZ7

grid to plate, 1.1  $\mu\text{f}$ ; input, 2.4  $\mu\text{f}$ ; output, 2.8  $\mu\text{f}$ . For diode operation curves, refer to type 6AV6. Type 6SZ7 is used principally for renewal purposes.

**TWIN DIODE—HIGH-MU TRIODE**

**6T7-G**

Glass octal type used as combined detector, amplifier, and avc tube in radio receivers. Outline 35, **OUTLINES SECTION**. For heater and cathode considerations, refer to type 6AV6. Heater volts (ac/dc), 6.3; amperes, 0.15. Typical operation as class A<sub>1</sub> amplifier: plate volts, 250 *max*; grid volts, -3; plate ma., 1.2; plate resistance, 62000 ohms; amplification factor,

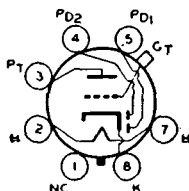

65; transconductance, 1050  $\mu$ mhos. For diode operation curves, refer to type 6AV6. Type 6T7-G is a **DISCONTINUED** type listed for reference only.

**TRIPLE DIODE—HIGH-MU TRIODE**

**6T8**

Miniature type used as combined audio amplifier, AM detector, and FM detector in AM/FM radio receivers. Diode unit No.1 is used for AM detection, and diode units No.2 and No.3

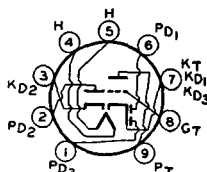

are used for FM detection. Outline 14, **OUTLINES SECTION**. Tube requires novel nine-contact socket and may be mounted in any position. For typical operation as a resistance-coupled amplifier, refer to Chart 7, **RESISTANCE-COUPLED AMPLIFIER SECTION**. For heater and cathode considerations, refer to type 6AQ5.

|  |                  |         |
|--|------------------|---------|
| <b>HEATER VOLTAGE (AC/DC)</b> .....                  | 6.3              | volts   |
| <b>HEATER CURRENT</b> .....                          | 0.45             | ampere  |
| <b>DIRECT INTERELECTRODE CAPACITANCES (Approx.):</b> |                  |         |
| Triode Grid to Triode Plate .....                    | 2.2              | $\mu$ f |
| Triode Grid to Cathode and Heater .....              | 1.6              | $\mu$ f |
| Triode Plate to Cathode and Heater .....             | 1.0              | $\mu$ f |
| Diode-No.1 Plate to Cathode and Heater .....         | 3.8              | $\mu$ f |
| Diode-No.2 Plate to Cathode and Heater .....         | 4.5              | $\mu$ f |
| Diode-No.3 Plate to Cathode and Heater .....         | 3.8              | $\mu$ f |
| Diode-No.2 Cathode to All Other Electrodes .....     | 8.5              | $\mu$ f |
| Triode Grid to Any Diode Plate .....                 | 0.035 <i>max</i> | $\mu$ f |

**TRIODE UNIT AS CLASS A<sub>1</sub> AMPLIFIER**

**Maximum Ratings:**

|  |                |       |
|--|----------------|-------|
| <b>PLATE VOLTAGE</b> .....                     | 300 <i>max</i> | volts |
| <b>GRID VOLTAGE, Positive Bias Value</b> ..... | 0 <i>max</i>   | volts |
| <b>PLATE DISSIPATION</b> .....                 | 1 <i>max</i>   | watt  |
| <b>PEAK HEATER-CATHODE VOLTAGE:</b>            |                |       |
| Heater negative with respect to cathode .....  | 90 <i>max</i>  | volts |
| Heater positive with respect to cathode .....  | 90 <i>max</i>  | volts |

**Characteristics:**

|                                   |       |       |            |
|-----------------------------------|-------|-------|------------|
| <b>Plate Voltage</b> .....        | 100   | 250   | volts      |
| <b>Grid Voltage</b> .....         | -1    | -3    | volts      |
| <b>Amplification Factor</b> ..... | 70    | 70    |            |
| <b>Plate Resistance</b> .....     | 54000 | 58000 | ohms       |
| <b>Transconductance</b> .....     | 1300  | 1200  | $\mu$ mhos |
| <b>Plate Current</b> .....        | 0.8   | 1.0   | ma         |

**DIODE UNITS**

**Maximum Rating:**

|  |              |    |
|--|--------------|----|
| <b>PLATE CURRENT (Each Unit)</b> ..... | 5 <i>max</i> | ma |
|--|--------------|----|

Diode units No.1 and No.3 have a common cathode. Diode unit No.2 has a separate cathode.

## AVERAGE PLATE CHARACTERISTICS

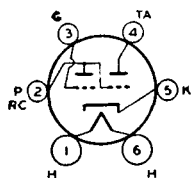
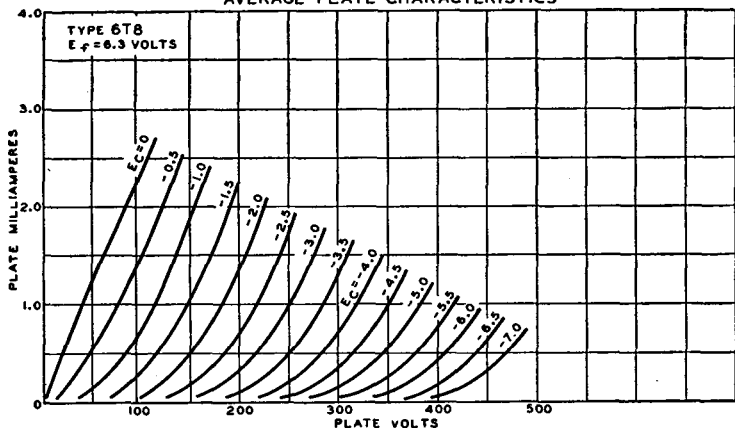

### ELECTRON-RAY TUBE

Glass type used to indicate visually, by means of a fluorescent target, the effects of a change in a controlling voltage. It is used as a convenient, non-mechanical means of indicating accurate radio-receiver tuning. Outline 31, OUTLINES SECTION. Tube requires six-contact socket and may be mounted in any position. For heater and cathode considerations,

## 6U5

refer to type 6AV6. Type 6U5 has a remote plate-current cutoff characteristic. For a discussion of electron-ray tube considerations, refer to ELECTRON TUBE APPLICATION SECTION. This type is used principally for renewal purposes.

|                             |     |        |
|-----------------------------|-----|--------|
| HEATER VOLTAGE (AC/DC)..... | 6.3 | volts  |
| HEATER CURRENT.....         | 0.3 | ampere |

### INDICATOR SERVICE

|  |  |                |       |
|--|--|----------------|-------|
| <b>Maximum Ratings:</b>                      |  |                |       |
| PLATE-SUPPLY VOLTAGE.....                    |  | 285 <i>max</i> | volts |
| TARGET VOLTAGE.....                          |  | 285 <i>max</i> | volts |
|  |  | 125 <i>min</i> | volts |
|  |  | 1 <i>max</i>   | watt  |
| PLATE DISSIPATION.....                       |  |                |       |
| PEAK HEATER-CATHODE VOLTAGE:                 |  |                |       |
| Heater negative with respect to cathode..... |  | 90 <i>max</i>  | volts |
| Heater positive with respect to cathode..... |  | 90 <i>max</i>  | volts |

### Typical Operation:

|   |       |      |        |
|---|-------|------|--------|
| Plate- and Target-Supply Voltage.....                   | 200   | 250  | volts  |
| Series Triode-Plate Resistor.....                       | 1     | 1    | megohm |
| Target Current (For zero grid voltage).....             | 3.0   | 4.0  | ma     |
| Triode Plate Current (For zero grid voltage).....       | 0.19  | 0.24 | ma     |
| Triode Grid Voltage (Approx. for 0° shadow angle).....  | -18.5 | -22  | volts  |
| Triode Grid Voltage (Approx. for 90° shadow angle)..... | 0     | 0    | volts  |

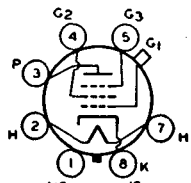

### REMOTE-CUTOFF PENTODE

Glass octal type used in rf and if stages of radio receivers employing avc. It is also used as a mixer in superheterodyne circuits. Outline 39, OUTLINES SECTION. Tube requires octal socket. Refer to type 6SK7 for general application information. Heater volts (ac/dc), 6.3; amperes, 0.3. Typical operation and maximum ratings as class A<sub>1</sub> amplifier: plate volts, 250

## 6U7-G

(300 *max*); grid-No.2 supply volts, 300 *max*; grid-No.2 volts, 100; grid No.3 connected to cathode at socket; grid-No.1 volts, -3; plate resistance (approx.), 0.8 megohm; transconductance, 1600  $\mu$ mhos; plate *ma.*, 8.2; grid-No.2 *ma.*, 2; plate dissipation, 2.25 *max* watts; grid-No.2 input, 0.25 *max* watt. This is a DISCONTINUED type listed for reference only.

## TRIODE—PENTODE CONVERTER

# 6U8

Miniature type used as combined oscillator and mixer tube in television receivers utilizing an intermediate frequency in the order of 40 megacycles per second. In such service, the 6U8

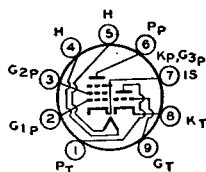

gives performance comparable to that obtainable with a 6AG5 mixer and an oscillator consisting of one unit of a type 6J6. When used in an AM/FM receiver, the triode unit is used as an oscillator for both sections. In the AM section, the pentode unit is used as a high-gain pentode mixer; in the FM section, the pentode unit is used either as a pentode mixer or as a triode-connected mixer depending on signal-to-noise consideration. Outline 14, OUTLINES SECTION. Tube requires noval nine-contact socket and may be mounted in any position.

|                     |      |        |
|---------------------|------|--------|
| HEATER VOLTAGE..... | 6.3  | volts  |
| HEATER CURRENT..... | 0.45 | ampere |

|  |  |                                     |               |
|--|--|-------------------------------------|---------------|
| <b>DIRECT INTERELECTRODE CAPACITANCES:</b>                                   |  |                                     |               |
|  | <i>Without<br/>External<br/>Shield</i> | <i>With<br/>External<br/>Shield</i> |               |
| <b>Triode Unit:</b>  |  |                                     |               |
| Grid to Plate.....   | 1.8                                    | 1.8                                 | $\mu\text{f}$ |
| Grid to Cathode and Heater.....  | 2.5                                    | 2.5                                 | $\mu\text{f}$ |
| Plate to Cathode and Heater.....   | 0.4                                    | 1.0                                 | $\mu\text{f}$ |
| <b>Pentode Unit:</b>   |  |                                     |               |
| Grid No.1 to Plate.....  | 0.010 max                              | 0.006 max                           | $\mu\text{f}$ |
| Grid No.1 to Cathode, Heater, Grid No.2, Grid No.3, and Internal Shield..... | 5.0                                    | 5.0                                 | $\mu\text{f}$ |
| Plate to Cathode, Heater, Grid No.2, Grid No.3, and Internal Shield.....     | 2.6                                    | 3.5                                 |               |
| Heater to Cathode (Approx., Each Unit).....                                  | 3.0                                    | 3.0                                 | $\mu\text{f}$ |

|  |                    |                     |                  |
|--|--------------------|---------------------|------------------|
| <b>Characteristics:</b>                                    |                    |                     |                  |
|  | <i>Triode Unit</i> | <i>Pentode Unit</i> |                  |
| Plate Voltage.....   | 150                | 250                 | volts            |
| Grid-No.2 Voltage.....                                     | —                  | 110                 | volts            |
| Cathode-Bias Resistor.....                                 | 56                 | 68                  | ohms             |
| Amplification Factor.....                                  | 40                 | —                   |                  |
| Plate Resistance (Approx.).....                            | 5000               | 400000              | ohms             |
| Transconductance.....                                      | 8500               | 5200                | $\mu\text{mhos}$ |
| Grid-No.1 Bias for plate current of 10 $\mu\text{a}$ ..... | -12                | -10                 | volts            |
| Plate Current.....   | 18                 | 10                  | ma               |
| Grid-No.2 Current.....                                     | —                  | 3.5                 | ma               |

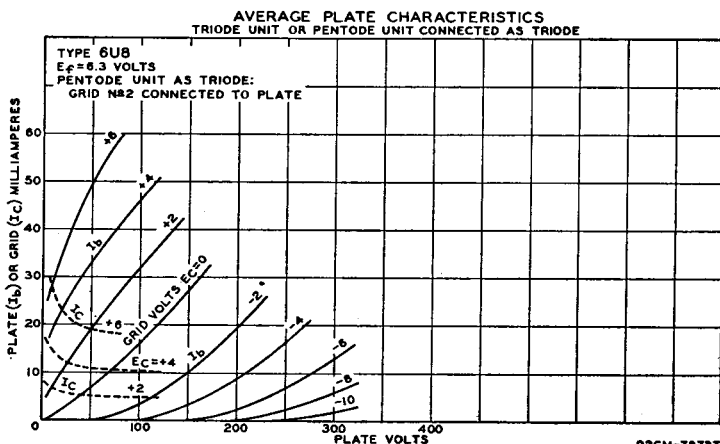

## CONVERTER SERVICE

|   |                    |                     |       |
|---|--------------------|---------------------|-------|
| <b>Maximum Ratings:</b>                               | <i>Triode Unit</i> | <i>Pentode Unit</i> |       |
| PLATE VOLTAGE.....                                    | 300 max            | 300 max             | volts |
| GRID-NO.2 (SCREEN) SUPPLY VOLTAGE.....                | -                  | 300 max             | volts |
| GRID-NO.2 VOLTAGE.....                                | -                  | See curve page 64   |       |
| <b>GRID-NO.1 (CONTROL-GRID) VOLTAGE:</b>              |                    |                     |       |
| Positive bias value.....                              | 0 max              | 0 max               | volts |
| PLATE DISSIPATION.....                                | 2.7 max            | 2.8 max             | watts |
| <b>GRID-NO.2 INPUT:</b>                               |                    |                     |       |
| For grid-No.2 voltages up to 150 volts.....           | -                  | 0.5 max             | watt  |
| For grid-No.2 voltages between 150 and 300 volts..... | -                  | See curve page 64   |       |
| <b>PEAK HEATER-CATHODE VOLTAGE:</b>                   |                    |                     |       |
| Heater negative with respect to cathode.....          | 90 max             | 90 max              | volts |
| Heater positive with respect to cathode.....          | 90 max             | 90 max              | volts |

**AVERAGE PLATE CHARACTERISTICS  
PENTODE UNIT**

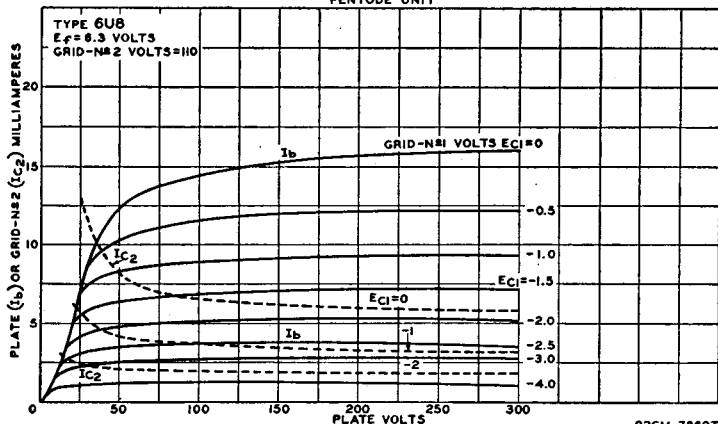

## BEAM POWER TUBE

Metal type 6V6 and glass-octal type 6V6-GT are used as output amplifiers in automobile, battery-operated, and other receivers in which reduced plate-current drain is desirable. Out-

# 6V6 6V6-GT

lines 6 and 23, respectively, **OUTLINES SECTION**. Type 6V6-GT may be supplied with pin No.1 omitted. Tubes require octal socket and may be mounted in any position. The 6V6 and 6V6-GT are equivalent in performance to type 6AQ5. Refer to type 6AQ5 for heater and cathode considerations, application information, and characteristic curves.

|  |                         |                   |
|--|-------------------------|-------------------|
| HEATER VOLTAGE (AC/DC).....                                | 6.3                     | volts             |
| HEATER CURRENT.....  | 0.45                    | ampere            |
| <b>DIRECT INTERELECTRODE CAPACITANCES (Approx.):</b>       |                         |                   |
| Grid No.1 to Plate.....                                    | 6V6 <sup>o</sup><br>0.3 | 6V6-GT<br>0.7 μμf |
| Grid No.1 to Cathode, Heater, Grid No.2, and Grid No.3.... | 10                      | 9.0 μμf           |
| Plate to Cathode, Heater, Grid No.2, and Grid No.3.....    | 11                      | 7.5 μμf           |

<sup>o</sup> With shell connected to cathode.

## SINGLE-TUBE CLASS A<sub>1</sub> AMPLIFIER

|  |         |       |  |
|--|---------|-------|--|
| <b>Maximum Ratings:</b>                      |         |       |  |
| PLATE VOLTAGE.....                           | 315 max | volts |  |
| GRID-NO.2 (SCREEN) VOLTAGE.....              | 285 max | volts |  |
| PLATE DISSIPATION.....                       | 12 max  | watts |  |
| GRID-NO.2 INPUT.....                         | 2 max   | watts |  |
| <b>PEAK HEATER-CATHODE VOLTAGE:</b>          |         |       |  |
| Heater negative with respect to cathode..... | 90 max  | volts |  |
| Heater positive with respect to cathode..... | 90 max  | volts |  |

### Typical Operation:

|                                       |      |       |     |       |
|---------------------------------------|------|-------|-----|-------|
| Plate Voltage.....                    | 180  | 250   | 315 | volts |
| Grid-No.2 Voltage.....                | 180  | 250   | 225 | volts |
| Grid-No.1 (Control-Grid) Voltage..... | -8.5 | -12.5 | -13 | volts |
| Peak AF Grid-No.1 Voltage.....        | 8.5  | 12.5  | 13  | volts |

|  |       |       |       |          |
|--|-------|-------|-------|----------|
| Zero-Signal Plate Current.....               | 29    | 45    | 34    | ma       |
| Maximum-Signal Plate Current.....            | 30    | 47    | 35    | ma       |
| Zero-Signal Grid-No.2 Current (Approx.)..... | 3     | 4.5   | 2.2   | ma       |
| Maximum-Signal Grid-No.2 Current (Approx.).. | 4     | 7     | 6     | ma       |
| Plate Resistance.....                        | 50000 | 50000 | 80000 | ohms     |
| Transconductance.....                        | 3700  | 4100  | 3750  | μmhos    |
| Load Resistance.....                         | 5500  | 5000  | 8500  | ohms     |
| Total Harmonic Distortion.....               | 8     | 8     | 12    | per cent |
| Maximum-Signal Power Output.....             | 2     | 4.5   | 5.5   | watts    |

### Maximum Ratings: PUSH-PULL CLASS AB<sub>1</sub> AMPLIFIER

(Same as for single-tube class A<sub>1</sub> amplifier)

#### Typical Operation (Values are for two tubes):

|  |       |       |          |
|--|-------|-------|----------|
| Plate Voltage.....                           | 250   | 285   | volts    |
| Grid-No.2 Voltage.....                       | 250   | 285   | volts    |
| Grid-No.1 (Control-Grid) Voltage.....        | -15   | -19   | volts    |
| Peak AF Grid-No.1-to-Grid-No.1 Voltage.....  | 30    | 38    | volts    |
| Zero-Signal Plate Current.....               | 70    | 70    | ma       |
| Maximum-Signal Plate Current.....            | 79    | 92    | ma       |
| Zero-Signal Grid-No.2 Current (Approx.)..... | 5     | 4     | ma       |
| Maximum-Signal Grid-No.2 Current (Approx.).. | 13    | 13.5  | ma       |
| Plate Resistance (Approx.).....              | 60000 | 70000 | ohms     |
| Transconductance.....                        | 3750  | 3600  | μmhos    |
| Effective Load Resistance.....               | 10000 | 8000  | ohms     |
| Total Harmonic Distortion.....               | 5     | 3.5   | per cent |
| Maximum-Signal Power Output.....             | 10    | 14    | watts    |

#### Maximum Circuit Values:

|                                 |         |        |
|---------------------------------|---------|--------|
| Grid-No.1-Circuit Resistance:   |         |        |
| For fixed-bias operation.....   | 0.1 max | megohm |
| For cathode-bias operation..... | 0.5 max | megohm |

### TWIN DIODE—MEDIUM-MU TRIODE

Glass octal type used as combined detector, amplifier, and avc tube. Outline 35, OUTLINES SECTION. Except for interelectrode capacitances, this type is identical electrically with type 85. Heater volts (ac/dc), 6.3; amperes, 0.3. For diode operation curves, refer to type 6AV6. Type 6V7-G is a DISCONTINUED type listed for reference only.

## 6V7-G

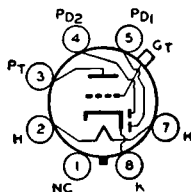

### HALF-WAVE VACUUM RECTIFIER

Glass octal type used as damper diode in magnetic deflection circuit of television receivers and as a rectifier in conventional power-supply applications. Outline 23, OUTLINES SECTION.

## 6W4-GT

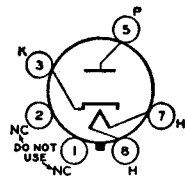

This type may be supplied with pin No.1 omitted. Tube requires octal socket and may be mounted in any position. It is especially important that this tube, like other power-handling tubes, be adequately ventilated. For curve of average plate characteristics, see page 61.

|                          |     |         |
|--------------------------|-----|---------|
| HEATER VOLTAGE (AC)..... | 6.3 | volts   |
| HEATER CURRENT.....      | 1.2 | amperes |

#### Maximum Ratings: DAMPER SERVICE

|   |          |       |
|---|----------|-------|
| PEAK INVERSE PLATE VOLTAGE*.....              | 3500 max | volts |
| PEAK PLATE CURRENT.....                       | 600 max  | ma    |
| DC PLATE CURRENT.....                         | 125 max  | ma    |
| PEAK HEATER-CATHODE VOLTAGE:                  |          |       |
| Heater negative with respect to cathode*..... | 2100 max | volts |
| Heater positive with respect to cathode.....  | 100 max  | volts |

\* The duration of the voltage pulse must not exceed 15% of one horizontal scanning cycle. In a 525-line, 30-frame system, 15% of one horizontal scanning cycle is 10 microseconds.

#### Maximum Ratings: RECTIFIER SERVICE

|  |          |         |
|--|----------|---------|
| PEAK INVERSE PLATE VOLTAGE.....  | 1250 max | volts   |
| PEAK PLATE CURRENT.....  | 600 max  | ma      |
| HOT-SWITCHING TRANSIENT PLATE CURRENT (For duration of 0.2 second max) | 3.5 max  | amperes |
| DC OUTPUT CURRENT.....   | 125 max  | ma      |

**PEAK HEATER-CATHODE VOLTAGE:**

|   |         |       |
|---|---------|-------|
| Heater negative with respect to cathode ..... | 450 max | volts |
| Heater positive with respect to cathode ..... | 100 max | volts |

**Typical Operation (Capacitor-Input Filter):**

|   | Half-Wave<br>Rectifier<br>(One Tube) | Full-Wave<br>Rectifier<br>(Two Tubes) |         |
|---|--------------------------------------|---------------------------------------|---------|
| AC Plate-to-Plate Supply Voltage (rms) .....                | —                                    | 700                                   | volts   |
| AC Plate-Supply Voltage (rms) .....                         | 350                                  | —                                     | volts   |
| Filter-Input Capacitor .....                                | 20                                   | 20                                    | $\mu$ f |
| Minimum Total Effective Plate-Supply Impedance per Plate .. | 145                                  | 145                                   | ohms    |
| DC Output Current .....                                     | 125                                  | 250                                   | ma      |
| <b>DC Output Voltage at Input to Filter (Approx.):</b>      |                                      |                                       |         |
| At half-load current of { 62.5 ma .....                     | 390                                  | —                                     | volts   |
| { 125 ma .....  | —                                    | 395                                   | volts   |
| At full-load current of { 125 ma .....                      | 335                                  | —                                     | volts   |
| { 250 ma .....  | —                                    | 350                                   | volts   |
| <b>Voltage Regulation (Approx.):</b>                        |                                      |                                       |         |
| Half-load to full-load current .....                        | 55                                   | 45                                    | volts   |

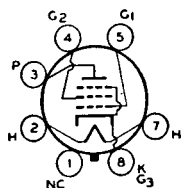

## BEAM POWER TUBE

Glass octal type used in the audio output stage of radio and television receivers. Triode-connected, it is used as a vertical deflection amplifier in television receivers. Outline 22 or 23,

# 6W6-GT

**OUTLINES SECTION.** This type may be supplied with pin No.1 omitted. Tube requires octal socket and may be mounted in any position.

|  |      |         |
|--|------|---------|
| HEATER VOLTAGE (AC/DC) .....                                 | 6.3  | volts   |
| HEATER CURRENT .....   | 1.2  | amperes |
| <b>DIRECT INTERELECTRODE CAPACITANCES:</b>                   |      |         |
| Grid No.1 to Plate .....                                     | 0.5  | $\mu$ f |
| Grid No.1 to Cathode, Heater, Grid No.2, and Grid No.3 ..... | 15.0 | $\mu$ f |
| Plate to Cathode, Heater, Grid No.2, and Grid No.3 .....     | 9.0  | $\mu$ f |

**Maximum Ratings:**

|   | CLASS A <sub>1</sub> AMPLIFIER |       |
|---|--------------------------------|-------|
| DC PLATE VOLTAGE .....                        | 300 max                        | volts |
| GRID-NO.2 (SCREEN) VOLTAGE .....              | 150 max                        | volts |
| PLATE DISSIPATION .....                       | 10 max                         | watts |
| GRID-NO.2 INPUT .....                         | 1.25 max                       | watts |
| <b>PEAK HEATER-CATHODE VOLTAGE:</b>           |                                |       |
| Heater negative with respect to cathode ..... | 200 max                        | volts |
| Heater positive with respect to cathode ..... | 200 max                        | volts |

■ The dc component must not exceed 100 volts.

AVERAGE PLATE CHARACTERISTICS  
PENTODE CONNECTION

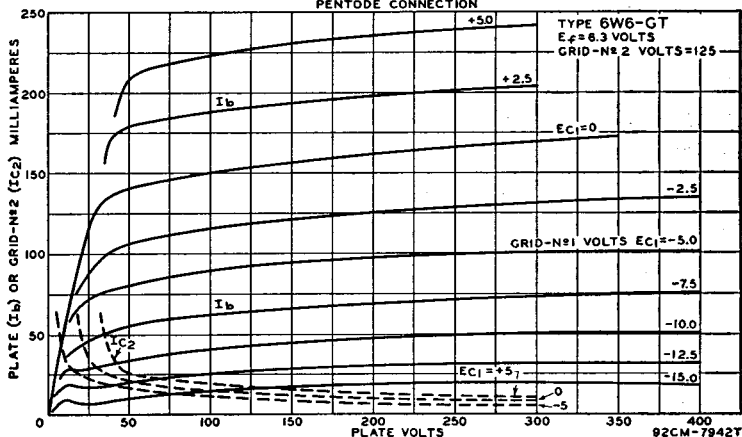

### Characteristics:

|                                     |       |       |            |
|-------------------------------------|-------|-------|------------|
| Plate Voltage                       | 110   | 200   | volts      |
| Grid-No.2 Voltage                   | 110   | 125   | volts      |
| Grid-No.1 (Control-Grid) Voltage    | -7.5  | -     | volts      |
| Cathode-Bias Resistor               | -     | 180   | ohms       |
| Peak AF Grid-No.1 Voltage           | 7.5   | 8.5   | volts      |
| Zero-Signal Plate Current           | 49    | 46    | ma         |
| Maximum-Signal Plate Current        | 50    | 47    | ma         |
| Zero-Signal Grid-No.2 Current       | 4     | 2.2   | ma         |
| Maximum-Signal Grid-No.2 Current    | 10    | 8.5   | ma         |
| Plate Resistance (Approx.)          | 13000 | 28000 | ohms       |
| Transconductance                    | 8000  | 8000  | $\mu$ mhos |
| Plate Load Resistance               | 2000  | 4000  | ohms       |
| Total Harmonic Distortion (Approx.) | 10    | 10    | per cent   |
| Maximum-Signal Power Output         | 2.1   | 3.8   | watts      |

### Maximum Circuit Values (For maximum rated conditions):

|                               |         |        |
|-------------------------------|---------|--------|
| Grid-No.1 Circuit Resistance: |         |        |
| For fixed-bias operation      | 0.1 max | megohm |
| For cathode-bias operation    | 0.5 max | megohm |

### Characteristics (Triode Connection)\*:

|   |      |            |
|---|------|------------|
| Plate Voltage   | 225  | volts      |
| Grid-No.1 Voltage   | -30  | volts      |
| Amplification Factor  | 6.2  |            |
| Plate Resistance  | 1600 | ohms       |
| Transconductance  | 3800 | $\mu$ mhos |
| Plate Current   | 22   | ma         |
| Grid-No.1 Voltage (Approx.) for Plate Current of 50 $\mu$ a | -42  | volts      |

\*Grid-No. 2 connected to plate.

### VERTICAL DEFLECTION AMPLIFIER (Triode Connection)\*

*For operation in a 525-line, 30-frame system*

#### Maximum Ratings:

|   |          |       |
|---|----------|-------|
| DC PLATE VOLTAGE                                      | 300 max  | volts |
| PEAK POSITIVE-PULSE PLATE VOLTAGE† (Absolute maximum) | 1200 max | volts |
| PEAK NEGATIVE-PULSE GRID-NO.1 VOLTAGE                 | -250 max | volts |
| <b>CATHODE CURRENT:</b>                               |          |       |
| Peak  | 140 max  | ma    |
| DC  | 40 max   | ma    |
| PLATE DISSIPATION                                     | 7.5 max  | watts |
| <b>PEAK HEATER-CATHODE VOLTAGE:</b>                   |          |       |
| Heater negative with respect to cathode               | 200 max  | volts |
| Heater positive with respect to cathode               | 200 max  | volts |

#### Maximum Circuit Value:

|                               |                 |
|-------------------------------|-----------------|
| Grid-No.1-Circuit Resistance: |                 |
| For cathode-bias operation    | 2.2 max megohms |

\* Grid No.2 connected to plate.

† The duration of the voltage pulse must not exceed 15 per cent of one vertical scanning cycle. In a 525-line, 30-frame system, 15 per cent of one vertical scanning cycle is 2.5 milliseconds.

° Under no circumstances should this absolute value be exceeded.

■ The dc component must not exceed 100 volts.

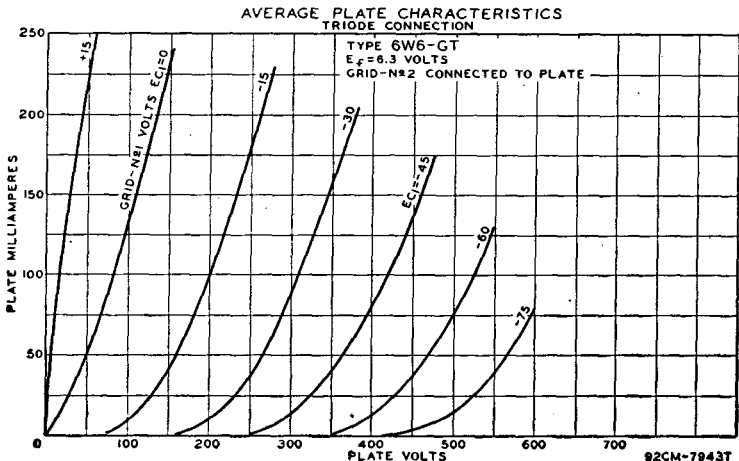



## SHARP-CUTOFF PENTODE

Glass octal type used as biased detector or high-gain amplifier in radio receivers. Outline 35, OUTLINES SECTION. Tube requires octal socket. Heater volts (ac/dc), 6.3; amperes, 0.15. Maximum ratings: plate volts, 300 *max*; grid-No.2 (screen) volts, 100 *max*; grid-No.2 supply volts, 300 *max*; grid-No.1 (control-grid) volts, 0 *min*; plate dissipation, 0.5 *max* watt; grid-No.2 input, 0.1 *max* watt. Within its maximum ratings, this type is identical electrically with type 6J7. Type 6W7-G is a DISCONTINUED type listed for reference only.

# 6W7-G

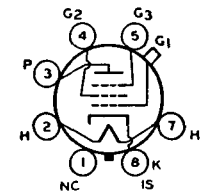

## FULL-WAVE VACUUM RECTIFIER

Miniature type used in power supply of automobile and ac-operated radio receivers. Equivalent in performance to larger types 6X5 and 6X5-GT. Type 6X4 requires miniature seven-contact socket and may be mounted in any position. Outline 16, OUTLINES SECTION. It is especially important that this tube, like other power-handling tubes, be adequately ventilated. For discussion of Rating Chart and Operation Characteristics, refer to type 6AX5-GT.

# 6X4

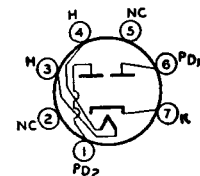

|                              |     |        |
|------------------------------|-----|--------|
| HEATER VOLTAGE (AC/DC) ..... | 6.3 | volts  |
| HEATER CURRENT .....         | 0.6 | ampere |

### Maximum Ratings:

### FULL-WAVE RECTIFIER

|   |                  |       |
|---|------------------|-------|
| PEAK INVERSE PLATE VOLTAGE .....              | 1250 <i>max</i>  | volts |
| PEAK PLATE CURRENT PER PLATE .....            | 210 <i>max</i>   | ma    |
| AC PLATE SUPPLY VOLTAGE (RMS) PER PLATE ..... | See Rating Chart |       |
| DC OUTPUT CURRENT PER PLATE .....             | See Rating Chart |       |
| HOT-SWITCHING TRANSIENT PLATE CURRENT .....   | #                |       |
| <b>PEAK HEATER-CATHODE VOLTAGE:</b>           |                  |       |
| Heater negative with respect to cathode ..... | 450 <i>max</i>   | volts |
| Heater positive with respect to cathode ..... | 450 <i>max</i>   | volts |

RATING CHART

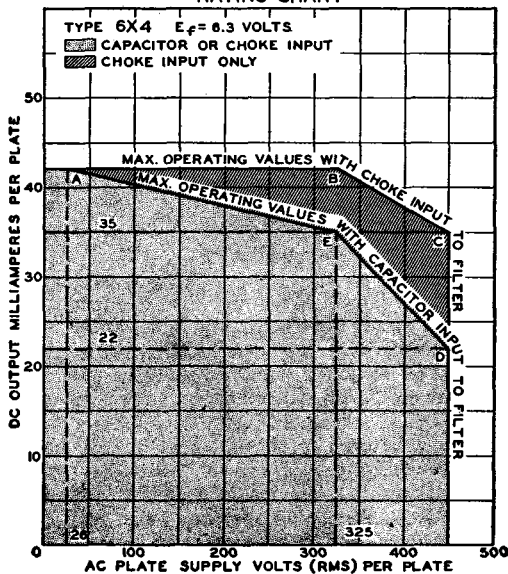

## Typical Operation:

| Filter Input                                    | Capacitor | Choke |         |
|---|-----------|-------|---------|
| AC Plate-to-Plate Supply Voltage (rms).....     | 650       | 900   | volts   |
| Filter Input Capacitor.....                     | 10*       | -     | $\mu$ f |
| Effective Plate Supply Impedance per Plate..... | 520       | -     | ohms    |
| Minimum Filter Input Choke.....                 | -         | 10    | henries |
| DC Output Voltage at Input to Filter (Approx.): |           |       |         |
| At half-load current of 35 ma.....              | 360       | 385   | volts   |
| At full-load current of 70 ma.....              | 300       | 370   | volts   |

# If hot-switching is regularly required in operation, the use of choke-input circuits is recommended. Such circuits limit the hot-switching current to a value no higher than that of the peak plate current. When capacitor-input circuits are used, a maximum peak current value per plate of 1 ampere during the initial cycles of the hot-switching transient should not be exceeded.

\* Higher values of capacitance than indicated may be used, but the effective plate-supply impedance should be increased to prevent exceeding the maximum rating for peak plate current.

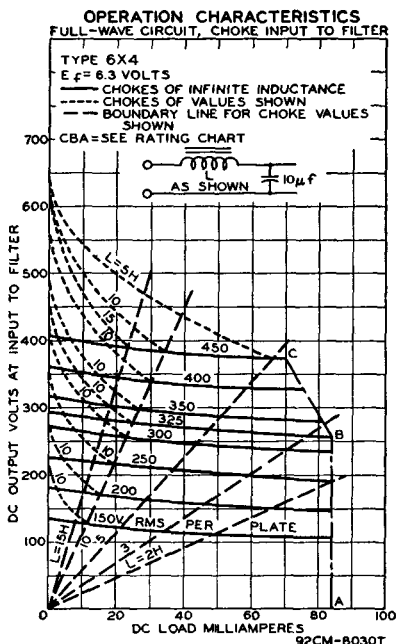
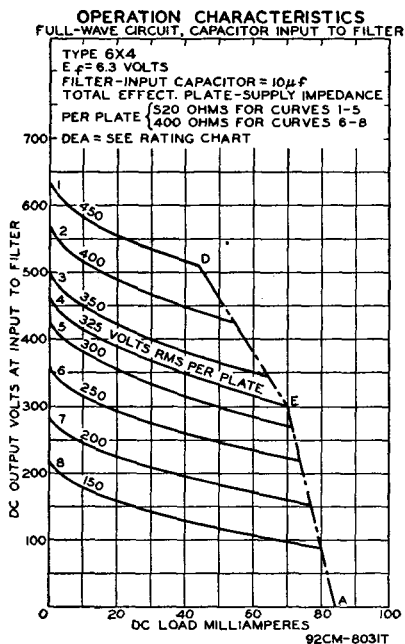

## 6X5 6X5-GT

### FULL-WAVE VACUUM RECTIFIER

Metal type 6X5 and glass-octal type 6X5-GT are used in power supply of automobile and ac-operated receivers. Outlines 6 and 23, respectively, OUTLINES SECTION. Type 6X5 is

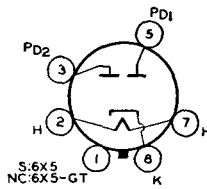

used principally for renewal purposes. Type 6X5-GT may be supplied with pin No.1 omitted. Both types require octal socket. Type 6X5 should be mounted in vertical position, but horizontal operation is permissible if pins 3 and 5 are in horizontal plane. Type 6X5-GT may be operated in any position. For maximum ratings, typical operation data, and curves, refer to type 6X4. Type 6X5 is used principally for renewal purposes.

**TRIODE-PENTODE CONVERTER**

**6X8**

Miniature type used as combined oscillator and mixer tube in television receivers utilizing an intermediate frequency in the order of 40 megacycles per second. In such service, the 6X8

gives performance comparable to that obtainable with a 6AG5 mixer and an oscillator consisting of one unit of a type 6J6. When used in an AM/FM receiver, the triode unit is used as an oscillator for both sections. In the AM section, the pentode unit is used as a high-gain pentode mixer; in the FM section, the pentode unit is used either as a pentode mixer or as a triode-connected mixer depending on signal-to-noise considerations. Outline 14, OUTLINES SECTION. Tube requires noval nine-contact socket and may be mounted in any position.

|                     |      |        |
|---------------------|------|--------|
| HEATER VOLTAGE..... | 6.3  | volts  |
| HEATER CURRENT..... | 0.45 | ampere |

**DIRECT INTERELECTRODE CAPACITANCES (Approx.):**

|   | <i>Without External Shield</i> | <i>With External Shield</i> |               |
|---|--------------------------------|-----------------------------|---------------|
| <b>TRIODE UNIT:</b>   |                                |                             |               |
| Grid to Plate.....  | 1.4                            | 1.4                         | $\mu\text{f}$ |
| Grid to Cathode and Heater.....                             | 2.0                            | 2.6                         | $\mu\text{f}$ |
| Plate to Cathode and Heater.....                            | 0.5                            | 1.0                         | $\mu\text{f}$ |
| <b>PENTODE UNIT:</b>  |                                |                             |               |
| Grid No.1 to Plate.....                                     | 0.09 max                       | 0.06 max                    | $\mu\text{f}$ |
| Grid No.1 to Cathode, Heater, Grid No.2, and Grid No.3..... | 4.3                            | 4.5                         | $\mu\text{f}$ |
| Plate to Cathode, Heater, Grid No.2, and Grid No.3.....     | 0.7                            | 1.4                         | $\mu\text{f}$ |
| Pentode Grid No.1 to Triode Plate.....                      | 0.045 max                      | 0.035 max                   | $\mu\text{f}$ |
| Pentode Plate to Triode Plate.....                          | 0.040 max                      | 0.008 max                   | $\mu\text{f}$ |

| <b>Characteristics:</b>                                    | <i>Triode Unit</i> | <i>Pentode Unit</i>            |                  |
|--|--------------------|--------------------------------|------------------|
| Plate Voltage.....   | 100                | 250                            | volts            |
| Grid No.3 (Suppressor).....                                | -                  | Connected to cathode at socket |                  |
| Grid-No.2 Voltage.....                                     | -                  | 150                            | volts            |
| Cathode-Bias Resistor.....                                 | 100                | 200                            | ohms             |
| Amplification Factor.....                                  | 40                 | -                              |                  |
| Plate Resistance (Approx.).....                            | 6900               | 750000                         | ohms             |
| Transconductance.....                                      | 5800               | 4600                           | $\mu\text{mhos}$ |
| Grid-No.1 Bias for plate current of 10 $\mu\text{a}$ ..... | -10                | -10                            | volts            |
| Plate Current.....   | 8.5                | 7.7                            | ma               |
| Grid-No.2 Current.....                                     | -                  | 1.6                            | ma               |

**AVERAGE PLATE CHARACTERISTICS TRIODE UNIT**

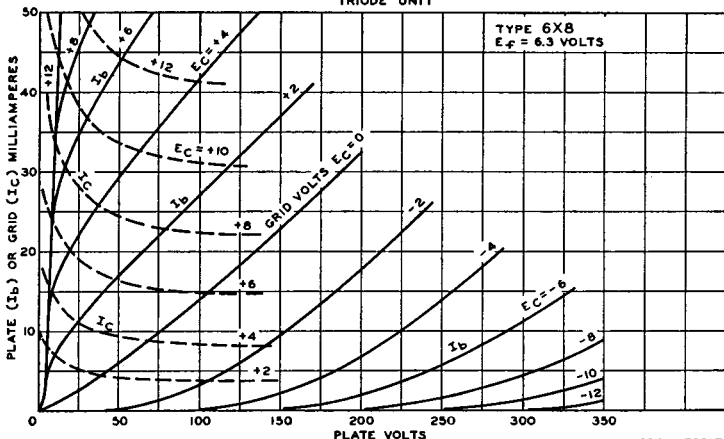

92CM-7531T

## CONVERTER SERVICE

| Maximum Ratings:                                      | <i>Triode Unit<br/>as Osc.</i> | <i>Pentode Unit<br/>as Mixer</i> |       |
|---|--------------------------------|----------------------------------|-------|
| PLATE VOLTAGE.....                                    | 250 max                        | 250 max                          | volts |
| GRID-NO.2 SUPPLY VOLTAGE.....                         | -                              | 250 max                          | volts |
| GRID-NO.2 (SCREEN) VOLTAGE.....                       | -                              | See curve page 64                |       |
| GRID-NO.1 (CONTROL-GRID) VOLTAGE:                     |                                |                                  |       |
| Negative bias value.....                              | 40 max                         | 40 max                           | volts |
| Positive bias value.....                              | 0 max                          | 0 max                            | volts |
| PLATE DISSIPATION.....                                | 1.5 max                        | 2.0 max                          | watts |
| GRID-NO.2 INPUT:                                      |                                |                                  |       |
| For grid-No.2 voltages up to 125 volts.....           | -                              | 0.4 max                          | watt  |
| For grid-No.2 voltages between 125 and 250 volts..... | -                              | See curve page 64                |       |
| GRID-NO.1 INPUT.....                                  | 0.5 max                        | -                                | watt  |
| PEAK HEATER-CATHODE VOLTAGE:                          |                                |                                  |       |
| Heater negative with respect to cathode.....          | 100 max                        | 100 max                          | volts |
| Heater positive with respect to cathode.....          | 100 max                        | 100 max                          | volts |

| Typical Operation:                         | <i>Triode Unit<br/>as 250-Mc Osc.</i> | <i>Pentode Unit<br/>as Mixer*</i> |            |
|--|---------------------------------------|-----------------------------------|------------|
| Plate Voltage.....                         | 150                                   | 150                               | volts      |
| Grid No.3.....                             | -                                     | Connected to cathode at socket    |            |
| Grid-No.2 Voltage.....                     | -                                     | 150                               | volts      |
| Mixer Grid-No.1 Supply Voltage.....        | -                                     | -3.5                              | volts      |
| Oscillator Voltage at Mixer Grid No.1..... | -                                     | 2.6 rms                           | volts      |
| Mixer Grid-No.1-Circuit Resistance.....    | -                                     | 120000                            | ohms       |
| Oscillator Grid Resistor.....              | 2700                                  | -                                 | ohms       |
| Conversion Transconductance.....           | -                                     | 2100                              | $\mu$ mhos |
| Plate Current.....                         | 13                                    | 6.2                               | ma         |
| Grid-No.2 Current.....                     | -                                     | 1.8                               | ma         |
| Grid-No.1 Current.....                     | -                                     | 2.0                               | ma         |
| Oscillator Power Output (Approx.).....     | 0.5†                                  | -                                 | watt       |

### Maximum Circuit Values:

|                                 |         |        |
|---------------------------------|---------|--------|
| Grid-No.1-Circuit Resistance:   |         |        |
| For fixed-bias operation.....   | 0.1 max | megohm |
| For cathode-bias operation..... | 0.5 max | megohm |

\*With separate excitation and triode unit grounded.

†In TV or FM receivers, it is generally desirable to operate the oscillator with less power input than shown in the tabulated data in order to avoid over-excitation and excessive oscillator radiation.

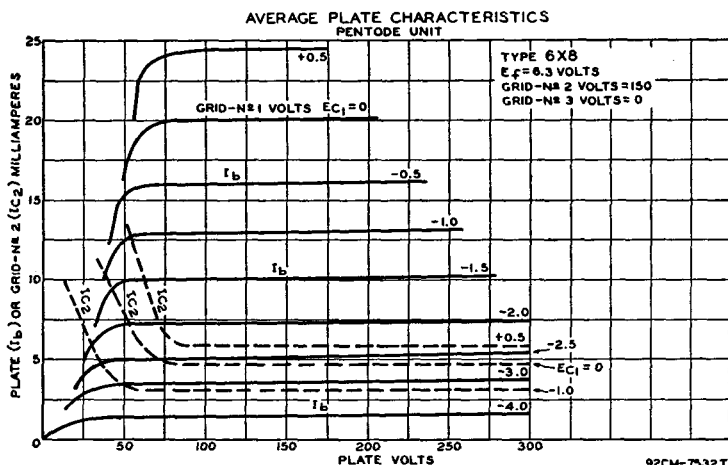

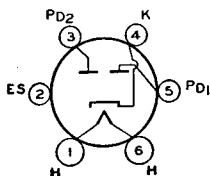

**FULL-WAVE VACUUM RECTIFIER**

Glass type used in power supply of radio receivers. Outline 31 or 34, OUTLINES SECTION. Heater volts (ac/dc), 6.3; amperes, 0.8. The maximum ac plate voltage per plate is 350 volts (rms), and the dc output current is 50 ma. This is a DISCONTINUED type listed for reference only.

**6Y5**

**BEAM POWER TUBE**

Glass octal type used as output amplifier in radio receivers in which the plate voltage available for the output stage is relatively low. It is also used in rf-operated, high-voltage power

**6Y6-G**

supplies in television equipment. Outline 37, OUTLINES SECTION. Tube requires octal socket and may be mounted in any position. Heater volts (ac/dc), 6.3; amperes, 1.25. Typical operation and maximum ratings as class A<sub>1</sub> amplifier: plate volts, 135 (200 max); grid-No.2 (screen) volts, 135 max; plate dissipation, 12.5 max watts; grid-No.2 input, 1.75 max watts; grid-No.1 (control-grid) volts, -13.5; plate ma., 58; grid-No.2 ma., 3.5; plate resistance, 9300 ohms; transconductance, 7000 μmhos; load resistance, 2000 ohms; maximum-signal output watts, 3.6. At maximum ratings, the 6Y6-G can deliver 6 watts output with load resistance of 2600 ohms.

**RF POWER AMPLIFIER AND OSCILLATOR—Class C Telegraphy**

**Maximum Ratings:**

|                           |         |       |
|---------------------------|---------|-------|
| DC PLATE VOLTAGE.....     | 350 max | volts |
| DC GRID-NO.2 VOLTAGE..... | 135 max | volts |
| DC GRID-NO.1 VOLTAGE..... | -90 max | volts |
| DC PLATE CURRENT.....     | 80 max  | ma    |
| DC GRID-NO.1 CURRENT..... | 1.5 max | ma    |
| PLATE INPUT.....          | 23 max  | watts |
| GRID-NO.2 INPUT.....      | 0.6 max | watt  |
| PLATE DISSIPATION.....    | 8.0 max | watts |

**Typical Operation:**

|                                     |     |       |
|-------------------------------------|-----|-------|
| DC Plate Voltage.....               | 350 | volts |
| DC Grid-No.2 Voltage*.....          | 115 | volts |
| DC Grid-No.1 Voltage.....           | -40 | volts |
| Peak RF Grid-No.1 Voltage.....      | 48  | volts |
| DC Plate Current.....               | 60  | ma    |
| DC Grid-No.2 Current.....           | 5.1 | ma    |
| DC Grid-No.1 Current (Approx.)..... | 1.4 | ma    |
| Driving Power (Approx.).....        | 0.1 | watt  |
| Power Output (Approx.).....         | 14  | watts |

\* Obtained from a separate source, from a potentiometer, or from plate supply through a series resistor of 45000 ohms.

† Obtained from fixed supply, by grid-No.1 resistor of 30000 ohms, by cathode resistor of 600 ohms, or by a combination of methods.

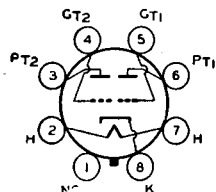

**HIGH-MU TWIN POWER TRIODE**

Glass octal type used as class B amplifier in output stage of radio receivers. Outline 33, OUTLINES SECTION. For electrical characteristics, refer to type 79. Heater volts (ac/dc), 6.3; amperes, 0.6. This is a DISCONTINUED type listed for reference only

**6Y7-G**

**FULL-WAVE VACUUM RECTIFIER**

Glass type used in power supply of radio receivers. Outline 34, OUTLINES SECTION. Heater volts (ac/dc), 12.6 in series heater arrangement and 6.3 in parallel arrangement; amperes, 0.4 (series), 0.8 (parallel). Maximum ac plate voltage per plate is 230 volts, and maximum dc output current is 60 ma. This is a DISCONTINUED type listed for reference only.

**6Z5**

**6Z7-G**

**HIGH-MU TWIN POWER TRIODE**

Glass octal type used as class B amplifier in output stage of radio receivers. Outline 33, OUTLINES SECTION. Tube requires octal socket. Heater volts (ac/dc), 6.3; amperes, 0.3. Typical operation and maximum ratings as class B power amplifier: plate volts, 180 *max*; grid volts, 0; peak plate ma. per plate, 60 *max*; average plate dissipation, 8 *max* watts; zero-signal plate ma. per plate, 4.2; plate-to-plate load resistance, 12000 ohms; output watts, 4.2 with average input of 320 milliwatts applied between grids. This is a DISCONTINUED type listed for reference only.

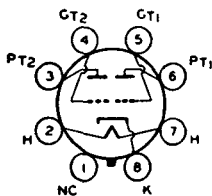

**6ZY5-G**

**FULL-WAVE VACUUM RECTIFIER**

Glass octal type used in power supply of radio equipment where economy of power is important. Outline 33, OUTLINES SECTION. Tube requires octal socket and may be mounted in any position. Heater volts (ac/dc), 6.3; amperes, 0.3. Maximum ratings: peak inverse plate volts, 1250; peak plate ma. per plate, 120; dc output ma., 40; peak heater-cathode volts, 450. This is a DISCONTINUED type listed for reference only.

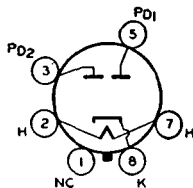

**7A4**

**MEDIUM-MU TRIODE**

Glass lock-in type used as detector, amplifier, or oscillator in radio equipment. Outline 15, OUTLINES SECTION. Tube requires lock-in socket. Heater volts (ac/dc), 6.3; amperes, 0.3. Maximum ratings, typical operating conditions, and curves for type 7A4 are the same as for metal type 6J5.

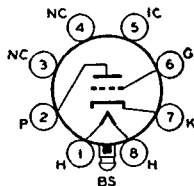

**7A5**

**BEAM POWER TUBE**

Glass lock-in type used as output amplifier in radio receivers in which the plate voltage available for the output stage is relatively low. Outline 20, OUTLINES SECTION. Tube requires lock-in socket. Heater volts (ac/dc), 6.3; amperes, 0.75. Typical operation and maximum ratings as class A<sub>1</sub> amplifier: plate volts, 110 (125 *max*); grid-No.2 volts, 110 (125 *max*); plate dissipation, 5.5 *max* watts; grid-No.2 input, 1.2 *max* watts; grid-No.1 volts, 7.5; plate ma., 40; grid-No.2 ma., 3; plate resistance, 16000 ohms; transconductance, 5800  $\mu$ mhos; load resistance, 2500 ohms; maximum-signal output watts, 1.5.

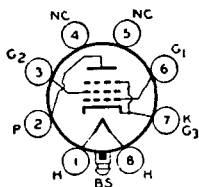

**7A6**

**TWIN DIODE**

Glass lock-in type used as detector, low-voltage rectifier, or avc tube. Outline 15, OUTLINES SECTION. Tube requires lock-in socket. Heater volts (ac/dc), 6.3; amperes, 0.15. Maximum ratings as rectifier: ac plate volts per plate (rms), 150; dc output ma. per plate, 8; peak ma. per plate, 45; peak heater-cathode volts, 330. The application of this type is similar to that of metal type 6H6

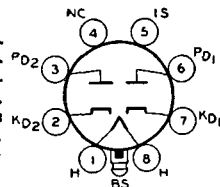

**7A7**

**REMOTE-CUTOFF PENTODE**

Glass lock-in type used as rf or if amplifier in radio receivers. Outline 15, OUTLINES SECTION. Tube requires lock-in socket. Heater volts (ac/dc), 6.3; amperes, 0.3. For maximum ratings, typical operation, and curves, refer to metal type 6SK7.

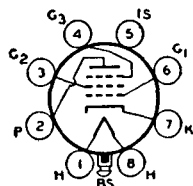

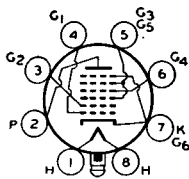

**OCTODE CONVERTER**

**7A8**

Glass lock-in type used as converter in superheterodyne circuits. Outline 15, OUTLINES SECTION. Tube requires lock-in socket. Heater volts (ac/dc), 6.3; amperes, 0.15. Typical operation and maximum ratings as frequency converter: plate volts, 250 (300 *max*); grids-No.3-and-No.5 volts, 100 *max*; grid-No.2 supply volts, 250 (300 *max*) applied through

20000-ohm dropping resistor properly bypassed; grid-No.2 volts, 165 (200 *max*); plate dissipation, 1 *max* watt; grids-No.3-and-No.5 input, 0.3 *max* watt; grid-No.2 input, 0.75 *max* watt; grid-No.4 volts, -3 (0 *min*); grid-No.1 resistor, 50000 ohms; plate ma., 3; grids-No.3-and-No.5 ma., 3.2; grid-No.2 ma., 4.2; grid-No.1 ma., 0.4; plate resistance, 0.7 megohm; conversion transconductance, 550  $\mu$ mhos; conversion transconductance with grid-No.1 bias of -30 volts, 2  $\mu$ mhos. The application of this type is similar to that of metal type 6A8 and glass-octal type 6D8-G.

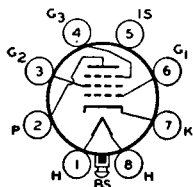

**POWER PENTODE**

**7AD7**

Lock-in type used in output stage of video amplifier of television receivers. Outline 20, OUTLINES SECTION. Tube requires lock-in socket. Heater volts (ac/dc), 6.3; amperes, 0.6. Typical operation and ratings as class A<sub>1</sub> video amplifier: plate volts, 300 *max*; grid-No.2 volts, 150 *max*; plate dissipation, 10 *max* watts; grid-No.2 input, 1.2 *max* watts; cathode resistor, 68

ohms; plate ma., 28; grid-No.2 ma., 7; plate resistance, 300000 ohms; transconductance, 9500  $\mu$ mhos.

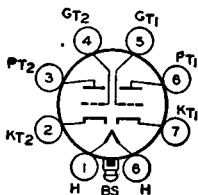

**MEDIUM-MU TWIN TRIODE**

**7AF7**

Glass lock-in type used as voltage amplifier or phase inverter in radio equipment. Outline 15, OUTLINES SECTION. Tube requires lock-in socket. Heater volts (ac/dc), 6.3; amperes, 0.3. Ratings and characteristics as class A<sub>1</sub> amplifier (each section): plate volts, 250 (300 *max*); cathode resistor, 1100 ohms; plate ma., 9; transconductance, 2100  $\mu$ mhos; amplification factor, 16; plate resistance, 7600 ohms.

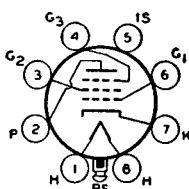

**SHARP-CUTOFF PENTODE**

**7AG7**

Glass lock-in type used as rf amplifier in ac/dc receivers or in mobile equipment where low heater-current drain is important. Outline 15, OUTLINES SECTION. Tube requires lock-in socket. Heater volts (ac/dc), 6.3; amperes, 0.15. Maximum ratings and characteristics as class A<sub>1</sub> amplifier: plate and grid-No.2 volts, 250 (300 *max*); plate dissipation, 2 *max* watts; grid-No.2 input, 0.75 *max* watt; grid

No.3 and internal shield connected to cathode at socket; plate resistance (approx.), 0.75 megohm; transconductance, 4200  $\mu$ mhos; grid-No.1 bias for plate current of 10  $\mu$ a., -10; cathode resistor, 250 ohms; plate ma., 6; grid-No.2 ma., 2. The application of this type is similar to that of miniature type 6BH6.

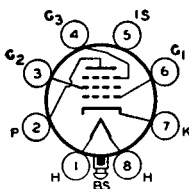

**REMOTE-CUTOFF PENTODE**

**7AH7**

Glass lock-in type used as rf amplifier in high-frequency and wide-band applications. Outline 15, OUTLINES SECTION. Tube requires lock-in socket. Heater volts (ac/dc), 6.3; amperes, 0.15. Maximum ratings and characteristics as class A<sub>1</sub> amplifier: plate and grid-No.2 volts, 250 (300 *max*); plate dissipation, 2 *max* watts; grid-No.2 input, 0.7 *max* watt; cathode resistor, 250 ohms; grid No.3 and internal shield

connected to cathode at socket; plate resistance (approx.), 1 megohm; transconductance, 3300  $\mu$ mhos; grid-No.1 bias for transconductance of 35  $\mu$ mhos, -20 volts; plate ma., 6.8; grid-No.2 ma., 1.9. The application of this type is similar to that of miniature type 6BJ6.

**7B4**

**HIGH-MU TRIODE**

Glass lock-in type used in resistance-coupled amplifier circuits. Outline 15, OUTLINES SECTION. Tube requires lock-in socket. Heater volts (ac/dc), 6.3; amperes, 0.3. Except for interelectrode capacitances, this type has the same maximum ratings and characteristics as metal types 6F5 and 6SF5.

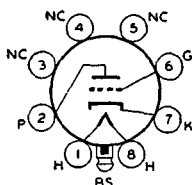

**7B5**

**POWER PENTODE**

Glass lock-in type used in output stage of radio receivers. Outline 20, OUTLINES SECTION. Tube requires lock-in socket. Heater volts (ac/dc), 6.3; amperes, 0.4. Except for interelectrode capacitances, this type is the same electrically as glass-octal type 6K6-GT.

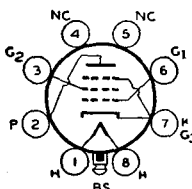

**7B6**

**TWIN DIODE—HIGH-MU TRIODE**

Glass lock-in type used as combined detector, amplifier, and avc tube. Outline 15, OUTLINES SECTION. Tube requires lock-in socket. Heater volts (ac/dc), 6.3; amperes, 0.3. Except for interelectrode capacitances, this type is the same electrically as metal type 6SQ7.

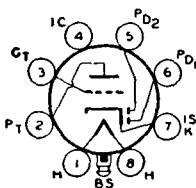

**7B7**

**REMOTE-CUTOFF PENTODE**

Glass lock-in type used as rf or if amplifier in radio receivers employing avc. Outline 15, OUTLINES SECTION. Tube requires lock-in socket. Heater volts (ac/dc), 6.3; amperes, 0.15. Typical operation as class A<sub>1</sub> amplifier: plate volts, 250 (300 max); grid-No.2 volts, 100; grid-No.1 volts, -3; grid No.3 connected to cathode at socket; plate ma., 8.5; grid-No.2

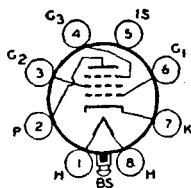

ma., 1.7; plate resistance, 0.75 megohm; transconductance, 1750  $\mu$ mhos; transconductance at bias of -40 volts, 10  $\mu$ mhos. The application of this type is similar to that of metal types 6SK7 and 6SS7.

**7B8**

**PENTAGRID CONVERTER**

Glass lock-in type used as frequency converter in superheterodyne circuits. Outline 15, OUTLINES SECTION. Tube requires lock-in socket. Heater volts (ac/dc), 6.3; amperes, 0.3. Except for interelectrode capacitances, this type is the same electrically as metal type 6A8.

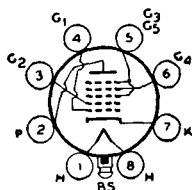

**7C5**

**BEAM POWER TUBE**

Glass lock-in type used as output amplifier in radio receivers. Outline 20, OUTLINES SECTION. Tube requires lock-in socket. Heater volts (ac/dc), 6.3; amperes, 0.45. Refer to metal type 6V6 for maximum ratings and typical operation as single-tube class A<sub>1</sub> amplifier and as push-pull amplifier, and for curves, to miniature type 6AQ5.

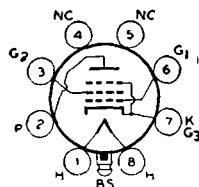



**TWIN DIODE—HIGH-MU TRIODE**

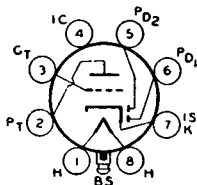

**7C6**

Glass lock-in type used as combined detector, amplifier, and avc tube. Outline 15, OUTLINES SECTION. Tube requires lock-in socket. Heater volts (ac/dc), 6.3; amperes, 0.15. Typical operation of triode unit as class A<sub>1</sub> amplifier: plate volts, 250 (300 max); grid volts, -1; plate ma., 1.3; plate resistance, 0.1 megohm; transconductance, 1000 μmhos. For diode operation curves and triode application, refer to metal type 6AV6.

**SHARP-CUTOFF PENTODE**

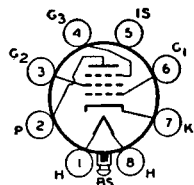

**7C7**

Glass lock-in type used as biased detector or rf amplifier. Outline 15, OUTLINES SECTION. Tube requires lock-in socket. Heater volts (ac/dc), 6.3; amperes, 0.15. Typical operation as class A<sub>1</sub> amplifier: plate volts, 250 (300 max); grid-No.2 volts, 100; grid-No.1 volts, -3 (0 min); grid No.3 and internal shield connected to cathode at socket; plate resistance (approx.), 2 megohms; plate ma., 2; grid-No.2 ma., 0.5; transconductance, 1300 μmhos. The application of this type is similar to that of metal type 6SJ7 and glass-octal type 6W7-G.

**TWIN DIODE—MEDIUM-MU TRIODE**

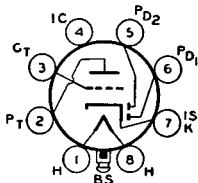

**7E6**

Glass lock-in type used as combined detector, amplifier, and avc tube. Outline 15, OUTLINES SECTION. Tube requires lock-in socket. Heater volts (ac/dc), 6.3; amperes, 0.3. For maximum ratings, typical operation, and curves, refer to miniature type 6BF6. Type 7E6 is a DISCONTINUED type listed for reference only.

**TWIN DIODE—REMOTE-CUTOFF PENTODE**

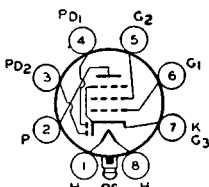

**7E7**

Glass lock-in type used as combined detector, amplifier, and avc tube. Outline 15, OUTLINES SECTION. Tube requires lock-in socket. Heater volts (ac/dc), 6.3; amperes, 0.3. Typical operation and maximum ratings of pentode unit as class A<sub>1</sub> amplifier: plate volts, 250 (300 max); grid-No.2 volts, 100 max; plate dissipation, 2 max watts; grid-No.2 input, 0.3 max watt; cathode-bias resistor, 330 ohms; plate resistance (approx.), 0.7 megohm; transconductance, 1300 μmhos; grid-No.1 bias for transconductance of 2 μmhos, -42.5; plate ma., 7.5; grid-No.2 ma., 1.6. For diode operation curves, refer to type 6AV6. Type 7E7 is used principally for renewal purposes.

**HIGH-MU TWIN TRIODE**

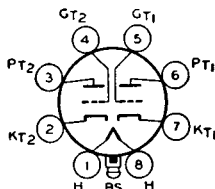

**7F7**

Glass lock-in type used as phase inverter or resistance-coupled amplifier. Outline 15, OUTLINES SECTION. Tube requires lock-in socket. Heater volts (ac/dc), 6.3; amperes, 0.3. For maximum ratings, typical operation as class A<sub>1</sub> amplifier, and curves, refer to glass-octal type 6SL7-GT.

**MEDIUM-MU TWIN TRIODE**

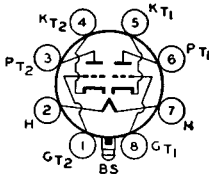

**7F8**

Glass lock-in type used as amplifier or oscillator in radio equipment. Outline 11, OUTLINES SECTION. Tube requires lock-in socket. Heater volts (ac/dc), 6.3; amperes, 0.3. Typical operation and maximum ratings as class A<sub>1</sub> amplifier (per unit): plate volts, 250 (300 max); cathode resistor, 500 ohms; plate ma., 6.0; transconductance, 3300 μmhos; amplification factor, 48; grid bias for plate current of 10 μa., -11; grid-circuit resistor, 0.5 max megohm.

**SHARP-CUTOFF PENTODE**

**7G7**

Glass lock-in type used in video amplifiers of television receivers and in other applications requiring high transconductance. Outline 15, OUTLINES SECTION. Tube requires lock-in socket. Heater volts (ac/dc), 6.3; amperes, 0.45. Typical operation and maximum ratings as class A<sub>1</sub> amplifier: plate volts, 250 (300 *max*); grid-No.2 volts, 100; plate dissipation, 1.5

*max* watts; grid-No.2 input, 0.3 *max* watt; grid-No.1 volts, -2; grid No.3 and internal shield connected to cathode at socket; plate resistance (approx.), 0.8 megohm; transconductance, 4500  $\mu$ mhos; grid-No.1 bias for cathode-current cutoff, -7; plate ma., 6; grid-No.2 ma., 2.0. The application of this type is similar to that of miniature type 6AU6.

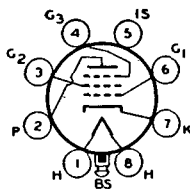

**REMOTE-CUTOFF PENTODE**

**7H7**

Glass lock-in type used as rf or if amplifier in radio receivers. Outline 15, OUTLINES SECTION. Tube requires lock-in socket. Heater volts (ac/dc), 6.3; amperes, 0.3. Typical operation and maximum ratings as class A<sub>1</sub> amplifier: plate volts, 250 (300 *max*); grid-No.2 volts, 150; plate dissipation, 2.5 *max* watts; grid-No.2 input, 0.5 *max* watt; grid No.3 and internal shield connected to cathode at socket; cathode resistor, 180 ohms; plate resistance (approx.), 0.8 megohm; transconductance, 4000  $\mu$ mhos; grid-No.1 volts for transconductance of 35  $\mu$ mhos, -19; plate ma., 10; grid-No.2 ma., 3.2. The application of this type is similar to that of miniature type 6BA6.

internal shield connected to cathode at socket; cathode resistor, 180 ohms; plate resistance (approx.), 0.8 megohm; transconductance, 4000  $\mu$ mhos; grid-No.1 volts for transconductance of 35  $\mu$ mhos, -19; plate ma., 10; grid-No.2 ma., 3.2. The application of this type is similar to that of miniature type 6BA6.

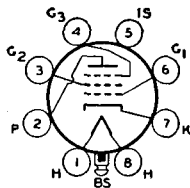

**TRIODE—HEPTODE CONVERTER**

**7J7**

Glass lock-in type used as combined oscillator and heptode mixer in radio receivers. Outline 15, OUTLINES SECTION. Tube requires lock-in socket. Heater volts (ac/dc), 6.3; amperes, 0.3. For maximum ratings and typical operation, refer to glass-octal type 6J8-G.

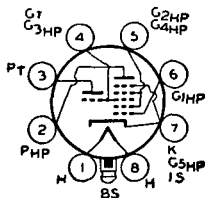

**TWIN DIODE—HIGH-MU TRIODE**

**7K7**

Glass lock-in type used as FM detector and audio amplifier in circuits which require diode and triode units with separate cathodes. Outline 15, OUTLINES SECTION. Tube requires lock-in socket. Heater volts (ac/dc), 6.3; amperes, 0.3. For ratings and typical operation, refer to glass-octal type 6AQ7-GT.

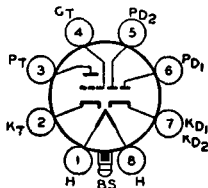

**SHARP-CUTOFF PENTODE**

**7L7**

Glass lock-in type used as rf and if amplifier in radio equipment. Outline 15, OUTLINES SECTION. Tube requires lock-in socket. Heater volts (ac/dc), 6.3; amperes, 0.3. Typical operation as class A<sub>1</sub> amplifier: plate volts, 250 (300 *max*); grid-No.2 volts, 100; grid-No.1 volts, -1.5; grid No.3 tied to cathode at socket; cathode resistor, 250 ohms; plate ma., 4.5;

grid-No.2 ma., 1.5; plate resistance (approx.), 1 megohm; transconductance, 3100  $\mu$ mhos. The application of this type is similar to that of miniature type 6AU6.

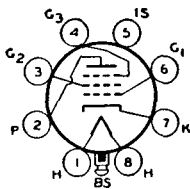

**MEDIUM-MU TWIN TRIODE**

**7N7**

Glass lock-in type used as voltage amplifier or phase inverter in radio equipment. Outline 20, OUTLINES SECTION. Tube requires lock-in socket. Heater volts (ac/dc), 6.3; amperes, 0.6. For maximum ratings and typical operation of each triode unit, refer to metal type 6J5. The application of this type is similar to that of glass-octal type 6SN7-GT.

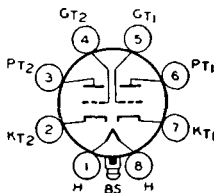

**PENTAGRID CONVERTER**

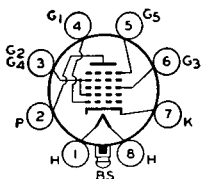

Glass lock-in type used as converter in superheterodyne circuits. Outline 15, OUTLINESSECTION. Tube requires lock-in socket. Heater volts (ac/dc), 6.3; amperes, 0.3. For maximum ratings, typical operation in converter service, and curves, refer to metal type 6SA7.

**7Q7**

**TWIN DIODE—REMOTE-CUTOFF PENTODE**

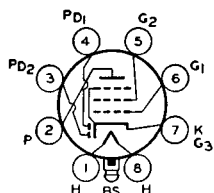

Glass lock-in type used as combined detector, amplifier, and avc tube. Outline 15, OUTLINESSECTION. Tube requires lock-in socket. Heater volts (ac/dc), 6.3; amperes, 0.3. Typical operation and ratings of pentode unit as class A<sub>1</sub> amplifier: plate volts, 250 *max*; grid-No.2 volts, 100; plate dissipation, 2 *max* watts; grid-No.2 input, 0.25 *max* watt; grid-No.1

**7R7**

volts, -1 (0 *min*); plate resistance (approx.), 1.0 megohm; transconductance, 3200  $\mu$ mhos; plate ma., 5.7; grid-No.2 ma., 2.1, grid-No.1 volts for transconductance of 10  $\mu$ mhos, -20. Refer to type 6AV6 for diode operation curves.

**TRIODE—HEPTODE CONVERTER**

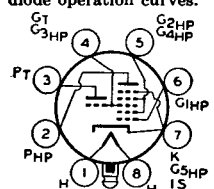

Glass lock-in type used as combined triode oscillator and heptode mixer in radio receivers. Outline 15, OUTLINESSECTION. Tube requires lock-in socket. Heater volts (ac/dc), 6.3; amperes, 0.3. Typical operation of heptode unit: plate volts, 250 (300 *max*); grids-No.2-and-No.4 volts, 100; grid-No.1 volts, -2; plate resistance, 1.25 megohms; conversion transconductance,

**7S7**

525  $\mu$ mhos; plate ma., 1.8; grids-No.2-and-No.4 ma., 3.0. Typical operation of triode unit: plate supply volts, 250 (300 *max*) applied through a 20000-ohm dropping resistor bypassed by a 0.1- $\mu$ f capacitor; grid resistor, 50000 ohms; plate ma., 5.0; total cathode ma. (both units), 10.2. This is a DISCONTINUED type listed for reference only.

**SHARP-CUTOFF PENTODE**

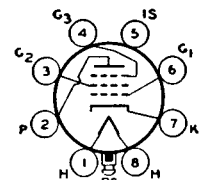

Glass lock-in type used as rf or if amplifier in radio receivers. Outline 15, OUTLINESSECTION. Tube requires lock-in socket. Heater volts (ac/dc), 6.3; amperes, 0.45. Typical operation and maximum ratings as class A<sub>1</sub> amplifier: plate volts and grid-No.2 supply volts, 300 *max*; grid-No.2 series resistor, 40000 ohms; plate dissipation, 4 *max* watts; grid-No.2 input,

**7V7**

0.8 *max* watt; grid No.3 connected to cathode at socket; cathode-bias resistor, 160 *min* ohms; plate resistance, 0.3 megohm; transconductance, 5800  $\mu$ mhos; plate ma., 10; grid-No.2 ma., 3.9; grid-No.1 bias for plate current of 10  $\mu$ a., -16. The application of this type is similar to that of miniature type 6AU6.

**SHARP-CUTOFF PENTODE**

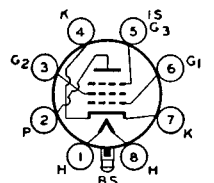

Glass lock-in type used as rf or if amplifier in radio receivers. Outline 15, OUTLINESSECTION. Tube requires lock-in socket. Heater volts (ac/dc), 6.3; amperes, 0.45. This type is the same as type 7V7 except for socket connections.

**7W7**

**TWIN DIODE—HIGH-MU TRIODE**

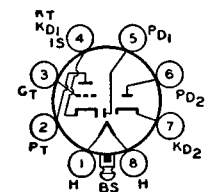

Glass lock-in type used as combined detector, amplifier, and avc tube in circuits which require diodes with separate cathodes. Outline 20, OUTLINESSECTION. Tube requires lock-in socket. Heater volts (ac/dc), 6.3; amperes, 0.3. Ratings and characteristics of triode unit as class A<sub>1</sub> amplifier: plate volts, 250 (300 *max*); grid volts, -1; amplification factor, 100; plate resistance, 67000 ohms; transconductance, 1500  $\mu$ mhos; plate ma., 1.9.

**7X7**

**FULL-WAVE VACUUM RECTIFIER**

Glass lock-in type used in power supply of automobile radio receivers and compact ac-operated receivers. Outline 15, **OUTLINES SECTION**. Tube requires lock-in socket. Heater volts (ac/dc), 6.3; amperes, 0.5. Maximum ratings: peak inverse plate volts, 1250; peak plate ma. per plate, 180; dc output ma., 70; peak heater-cathode volts, 450. For typical operation, refer to miniature type 6X4.

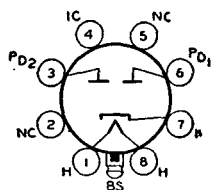

**7Y4**

**FULL-WAVE VACUUM RECTIFIER**

Glass lock-in type used in power supply of automobile and ac-operated radio receivers. Outline 20, **OUTLINES SECTION**. Tube requires lock-in socket. Heater volts (ac/dc), 6.3; amperes, 0.9. Maximum ratings: peak inverse plate volts, 1250; peak plate ma. per plate, 300; dc output ma., 100; peak heater-cathode volts, 450.

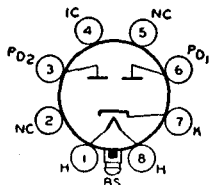

**7Z4**

**Typical Operation:**

**FULL-WAVE RECTIFIER**

| Filter Input   | Capacitor | Choke |         |
|--|-----------|-------|---------|
| AC Plate-to-Plate Supply Voltage (rms) . . . . .                 | 650       | 900   | volts   |
| Filter-Input Capacitor . . . . .                                 | 4         | -     | $\mu$ f |
| Min. Total Effective Plate-Supply Impedance per Plate† . . . . . | 75        | -     | ohms    |
| Min. Filter-Input Choke . . . . .                                | -         | 6     | henries |
| DC Output Current . . . . .                                      | 100       | 100   | ma      |

† When a filter capacitor larger than 40 $\mu$ f is used, it may be necessary to use more plate-supply impedance than the minimum value shown to limit the peak plate current to the rated value.

**POWER TRIODE**

Glass type used as an audio-frequency amplifier. Outline 43, **OUTLINES SECTION**. Tube requires four-contact socket and should be operated in vertical position with base down. Filament volts (ac/dc), 7.5; amperes, 1.25. Typical operation as class A<sub>1</sub> af power amplifier: plate volts, 425 max; grid volts, -40; peak af grid volts, 35; plate ma., 18; plate resistance,

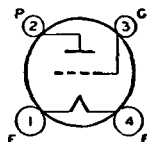

**10**

5000 ohms; transconductance, 1600  $\mu$ mhos; load resistance, 10200 ohms; undistorted output watts, 1.6. This is a **DISCONTINUED** type listed for reference only. Replace by transmitting type 10-Y.

**DETECTOR AMPLIFIER**

Glass types used as detectors and amplifiers in battery-operated receivers. Filament volts (dc), 1.1; amperes, 0.25. Typical operation as class A<sub>1</sub> amplifier: plate volts, 135 max; grid volts, -10.5; plate resistance, 15500 ohms; transconductance, 440  $\mu$ mhos; plate ma., 8. These are **DISCONTINUED** types listed for reference only.

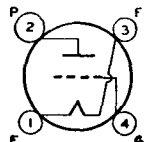

**11**

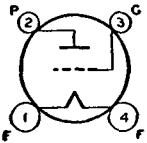

**12**

**POWER PENTODE**

Glass type used as output amplifier in ac/dc radio receivers. Outline 31 or 34, **OUTLINES SECTION**. Heater volts (ac/dc), 12.6 in series heater arrangement and 6.3 in parallel arrangement; amperes, 0.8 (series), 0.6 (parallel). Typical operation as class A<sub>1</sub> amplifier: plate volts and grid-No.2 volts, 180 max; grid-No.1 volts, -25; plate ma., 45; grid-No.2 ma., 8; plate resistance, 35000 ohms; transconductance, 2400  $\mu$ mhos; load resistance, 3300 ohms; output watts, 8.4. This is a **DISCONTINUED** type listed for reference only.

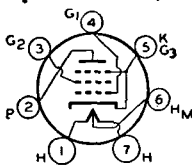

**12A5**

This is a **DISCONTINUED** type listed for reference only.

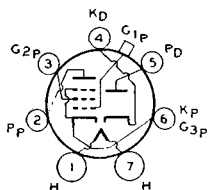

**RECTIFIER—POWER PENTODE**

Glass type used as combined half-wave rectifier and power amplifier. Outline 36, OUTLINES SECTION. Tube requires small seven-contact (0.75-inch, pin-circle diameter) socket. Heater volts (ac/dc), 12.6; amperes, 0.3. Typical operation of pentode unit as class A<sub>1</sub> amplifier: plate volts and grid-No.2 volts, 135 *max*; grid-No.1 volts, -13.5; load resistance, 13500

**12A7**

ohms; plate resistance, 100000 ohms; transconductance, 975  $\mu$ mhos; cathode resistance, 1175 ohms; plate ma., 9; grid-No.2 ma., 2.5; output watts, 0.55. Maximum ratings of rectifier unit with capacitor-input filter: ac plate volts (rms), 125; dc output ma., 30. This is a DISCONTINUED type listed for reference only.

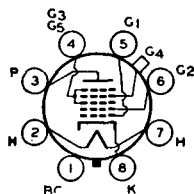

**PENTAGRID CONVERTER**

Glass octal type used as converter in ac/dc receivers. Outline 24, OUTLINES SECTION. Heater volts (ac/dc), 12.6; amperes, 0.15. Except for heater rating, this type is identical with glass-octal type 6A8-GT. This type is used principally for renewal purposes.

**12A8-GT**

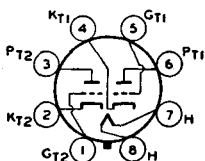

**MEDIUM-MU TWIN TRIODE**

Glass octal tube used as audio amplifier in radio equipment. Outline 18, OUTLINES SECTION. Tube requires octal socket. Heater volts (ac/dc), 12.6; amperes, 0.15. Typical operation as class A<sub>1</sub> amplifier: plate volts, 180 *max*; grid volts, -6.5; amplification factor, 16; transconductance, 1900  $\mu$ mhos; plate resistance, 8400 ohms; plate ma., 7.6; grid-bias volts for plate current of 10  $\mu$ a., -16. This type is used principally for renewal purposes.

**12AH7-GT**

**TWIN DIODE**

Miniature, high-perveance type used as detector in FM and television circuits. It is especially useful as a ratio detector in ac/dc FM receivers. Outline 9, OUTLINES SECTION. Heater volts (ac/dc), 12.6; amperes, 0.15. Except for heater rating, this type is identical with miniature type 6AL5.

**12AL5**

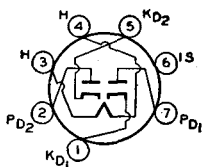

**BEAM POWER TUBE**

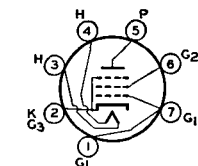

(ac/dc), 12.6; amperes, 0.225. Except for heater rating, this type is identical with miniature type 6AQ5. Within its maximum ratings, the performance of the 12AQ5 is equivalent to that of the larger type 12V6-GT.

**12AQ5**

### TWIN DIODE— HIGH-MU TRIODE

## 12AT6

Miniature type used as a combined detector, amplifier, and avc tube in compact ac/dc radio receivers. Outline 13, OUTLINES SECTION. Heater volts (ac/dc), 12.6; amperes, 0.15. Except for the heater rating, this type is identical with miniature type 6AT6.

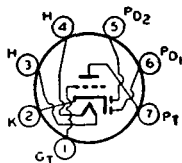

### HIGH-MU TWIN TRIODE

## 12AT7

Miniature type used as cathode-drive amplifier or frequency converter in the FM and television broadcast bands. Outline 14, OUTLINES SECTION. Tube requires noval nine-contact socket and may be mounted in any position. Each triode unit is independent of the other except for the common heater.

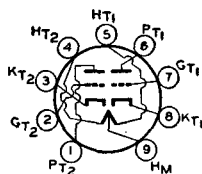

Each triode unit is independent of the other except for the common heater.

| HEATER ARRANGEMENT                           | Series | Parallel  |               |
|--|--------|-----------|---------------|
| HEATER VOLTAGE (AC/DC).....                  | 12.6   | 6.3       | volts         |
| HEATER CURRENT.....                          | 0.15   | 0.8       | ampere        |
| <b>DIRECT INTERELECTRODE CAPACITANCES:</b>   |        |           |               |
| Grid to Grid.....                            |        | 0.005 max | $\mu\text{f}$ |
| Plate to Plate.....                          |        | 0.4 max   | $\mu\text{f}$ |
| Grid to Plate (Each Unit).....               |        | 1.5       | $\mu\text{f}$ |
| Grid to Cathode and Heater (Each Unit).....  |        | 2.2       | $\mu\text{f}$ |
| Plate to Cathode and Heater (Unit No.1)..... |        | 0.5       | $\mu\text{f}$ |
| Plate to Cathode and Heater (Unit No.2)..... |        | 0.4       | $\mu\text{f}$ |
| Heater to Cathode (Each Unit).....           |        | 2.4       | $\mu\text{f}$ |
| Plate to Cathode (Each Unit).....            |        | 0.2       | $\mu\text{f}$ |
| Cathode to Heater and Grid (Each Unit).....  |        | 4.6       | $\mu\text{f}$ |
| Plate to Heater and Grid (Each Unit).....    |        | 1.8       | $\mu\text{f}$ |

| Maximum Ratings:                       | CLASS A <sub>1</sub> AMPLIFIER (Each Unit) |       |
|--|--|-------|
| PLATE VOLTAGE.....                     | 300 max                                    | volts |
| GRID VOLTAGE, Negative Bias Value..... | -50 max                                    | volts |
| PLATE DISSIPATION.....                 | 2.5 max                                    | watts |

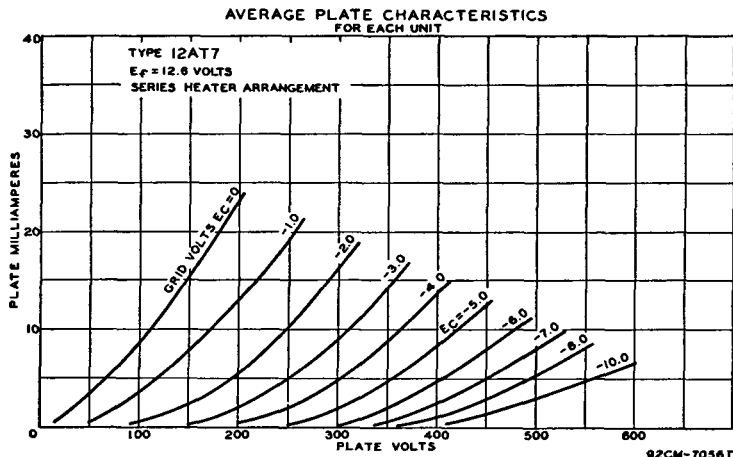

**PEAK HEATER-CATHODE VOLTAGE:**

|  |               |       |
|--|---------------|-------|
| Heater negative with respect to cathode..... | 90 <i>max</i> | volts |
| Heater positive with respect to cathode..... | 90 <i>max</i> | volts |

**Characteristics:**

|  |       |       |           |
|--|-------|-------|-----------|
| Plate Voltage.....                                       | 100   | 250   | volts     |
| Cathode Resistor.....                                    | 270   | 200   | ohms      |
| Amplification Factor.....                                | 60    | 60    |           |
| Plate Resistance (Approx.).....                          | 15000 | 10900 | ohms      |
| Transconductance.....                                    | 4000  | 5500  | $\mu$ hos |
| Grid Bias (Approx.) for plate current of 10 $\mu$ a..... | -5    | -12   | volts     |
| Plate Current.....                                       | 3.7   | 10    | ma        |

## SHARP-CUTOFF PENTODE

Miniature type used in compact ac/dc radio equipment as an rf amplifier especially in high-frequency, wide-band applications. Outline 13, **OUTLINES SECTION**. Heater volts (ac/dc), 12.6; amperes, 0.15. Except for heater rating, this type is identical with miniature type 6AU6.

# 12AU6

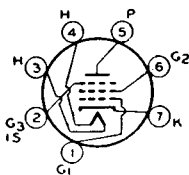

## MEDIUM-MU TWIN TRIODE

Miniature type used as phase inverter or amplifier in ac/dc radio equipment and in many diversified applications such as multivibrators or oscillators in industrial control de-

# 12AU7

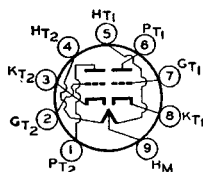

VICES. Outline 14, **OUTLINES SECTION**. Tube requires noval nine-contact socket and may be mounted in any position. Its characteristics are similar to glass-octal type 6SN7-GT. Each triode unit is independent of the other except for the common heater. For typical operation as a resistance-coupled amplifier, refer to Chart 10, **RESISTANCE-COUPLED AMPLIFIER SECTION**.

| HEATER ARRANGEMENT                                   | <i>Series</i>     | <i>Parallel</i>   |         |
|--|-------------------|-------------------|---------|
| HEATER VOLTAGE (AC/DC).....                          | 12.6              | 6.3               | volts   |
| HEATER CURRENT.....                                  | 0.15              | 0.3               | ampere  |
| <b>DIRECT INTERELECTRODE CAPACITANCES (Approx.):</b> |                   |                   |         |
|  | <i>Unit No. 1</i> | <i>Unit No. 2</i> |         |
| Grid to Plate.....                                   | 1.5               | 1.5               | $\mu$ f |
| Grid to Cathode and Heater.....                      | 1.6               | 1.6               | $\mu$ f |
| Plate to Cathode and Heater.....                     | 0.50              | 0.35              | $\mu$ f |

**Maximum Ratings:**

### CLASS A<sub>1</sub> AMPLIFIER (Each Unit)

|  |                 |       |
|--|-----------------|-------|
| PLATE VOLTAGE.....                           | 300 <i>max</i>  | volts |
| PLATE DISSIPATION.....                       | 2.75 <i>max</i> | watts |
| CATHODE CURRENT.....                         | 20 <i>max</i>   | ma    |
| <b>GRID VOLTAGE:</b>                         |                 |       |
| Negative bias value.....                     | 50 <i>max</i>   | volts |
| Positive bias value.....                     | 0 <i>max</i>    | volts |
| <b>PEAK HEATER-CATHODE VOLTAGE:</b>          |                 |       |
| Heater negative with respect to cathode..... | 180 <i>max</i>  | volts |
| Heater positive with respect to cathode..... | 180 <i>max</i>  | volts |

**Characteristics:**

|  |      |      |           |
|--|------|------|-----------|
| Plate Voltage.....                                       | 100  | 250  | volts     |
| Grid Voltage.....  | 0    | -8.5 | volts     |
| Amplification Factor.....                                | 20   | 17   |           |
| Plate Resistance (Approx.).....                          | 6500 | 7700 | ohms      |
| Transconductance.....                                    | 3100 | 2200 | $\mu$ hos |
| Grid Bias (Approx.) for plate current of 10 $\mu$ a..... | -    | -24  | volts     |
| Plate Current.....                                       | 11.8 | 10.5 | ma        |

## Maximum Circuit Values (For maximum rated conditions):

### Grid-Circuit Resistance:

|                                 |          |        |
|---------------------------------|----------|--------|
| For fixed-bias operation.....   | 0.25 max | megohm |
| For cathode-bias operation..... | 1.0 max  | megohm |

**AVERAGE PLATE CHARACTERISTICS**  
EACH TRIODE UNIT

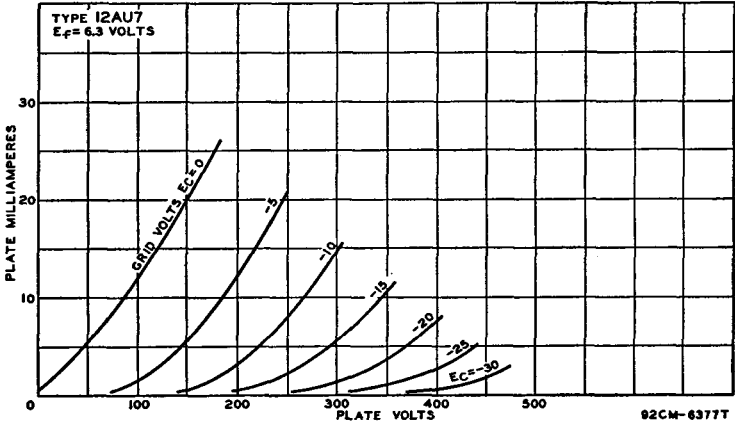

## 12AV6

### TWIN DIODE— HIGH-MU TRIODE

Miniature type used as combined detector, amplifier, and avc tube in automobile and ac-operated receivers. Outline 13, OUTLINES SECTION.

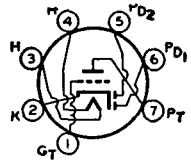

Heater volts (ac/dc), 12.6; amperes, 0.15. Except for heater rating, this type is identical with miniature type 6AV6.

## 12AV7

### MEDIUM-MU TWIN TRIODE

Miniature type used as frequency converter in vhf tuners of television receivers. Also used as rf amplifier, oscillator, or mixer. Outline 14, OUTLINES SECTION. Tube requires

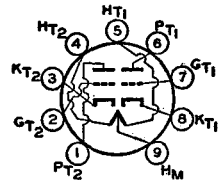

noval nine-contact socket and may be mounted in any position. Each triode unit is independent of the other except for the common heater.

|                                     |               |                 |         |
|-------------------------------------|---------------|-----------------|---------|
| <b>HEATER ARRANGEMENT</b> .....     | <i>Series</i> | <i>Parallel</i> |         |
| <b>HEATER VOLTAGE (AC/DC)</b> ..... | 12.6          | 6.3             | volts   |
| <b>HEATER CURRENT</b> .....         | 0.225         | 0.45            | amperes |

### DIRECT INTERELECTRODE CAPACITANCES:

|  | <i>Without<br/>External<br/>Shield</i> | <i>With<br/>External<br/>Shield</i> |         |
|--|--|-------------------------------------|---------|
| Grid to Plate (Each Unit).....               | 1.9                                    | 1.9                                 | $\mu$ f |
| Grid to Cathode and Heater (Each Unit).....  | 3.1                                    | 3.2                                 | $\mu$ f |
| Plate to Cathode and Heater (Unit No.1)..... | 0.5                                    | 1.3                                 | $\mu$ f |
| Plate to Cathode and Heater (Unit No.2)..... | 0.4                                    | 1.6                                 | $\mu$ f |
| Heater to Cathode (Each Unit).....           | 3.8                                    | 4.0                                 | $\mu$ f |
| Plate to Cathode (Each Unit).....            | 0.24                                   | 0.23                                | $\mu$ f |
| Cathode to Heater and Grid (Each Unit).....  | 6.9                                    | 7.0                                 | $\mu$ f |
| Plate to Heater and Grid (Unit No.1).....    | 2.0                                    | 2.8                                 | $\mu$ f |
| Plate to Heater and Grid (Unit No.2).....    | 2.0                                    | 3.2                                 | $\mu$ f |



## CLASS A<sub>1</sub> AMPLIFIER (Each Unit)

### Maximum Ratings:

|  |         |       |
|--|---------|-------|
| PLATE VOLTAGE.....                           | 300 max | volts |
| DC GRID VOLTAGE:                             |         |       |
| Negative Bias Value.....                     | 50 max  | volts |
| PLATE DISSIPATION.....                       | 2.7 max | watts |
| PEAK HEATER-CATHODE VOLTAGE:                 |         |       |
| Heater negative with respect to cathode..... | 90 max  | volts |
| Heater positive with respect to cathode..... | 90 max  | volts |

### Characteristics:

|  |      |      |            |
|--|------|------|------------|
| Plate Voltage.....                                       | 100  | 150  | volts      |
| Cathode-Bias Resistor.....                               | 120  | 56   | ohms       |
| Amplification Factor.....                                | 37   | 41   |            |
| Plate Resistance (Approx.).....                          | 6100 | 4800 | ohms       |
| Transconductance.....                                    | 6100 | 8500 | $\mu$ mhos |
| Plate Current.....                                       | 9    | 18   | ma         |
| Grid Bias (Approx.) for plate current of 10 $\mu$ a..... | -9   | -12  | volts      |

## SHARP-CUTOFF PENTODE

Miniature type used as an rf or if amplifier up to 400 megacycles in compact ac/dc FM receivers. Outline 13, OUTLINES SECTION. Tube requires miniature seven-contact socket and may be mounted in any position. Heater volts (ac/dc), 12.6; amperes, 0.15. Except for heater ratings and terminal connections, this type is identical with miniature type 6AG5. Type 12AW6 is used principally for renewal purposes.

# 12AW6

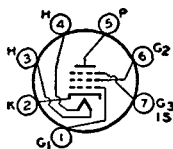

## HALF-WAVE VACUUM RECTIFIER

Glass octal type used as a damper tube in horizontal deflection circuits of television receivers utilizing series-heater strings. Outline 22, OUTLINES SECTION. Tube requires octal socket

# 12AX4-GT

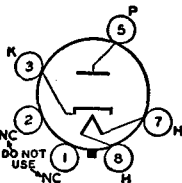

and may be mounted in any position. This type may be supplied with pin No.1 omitted. Heater volts (ac/dc), 12.6; amperes, 0.6. Except for heater rating, this type is identical with glass octal type 6AX4-GT.

## HIGH-MU TWIN TRIODE

Miniature type used as phase inverter or resistance-coupled amplifier in radio equipment and in many diversified applications such as multivibrators or oscillators in industrial control

# 12AX7

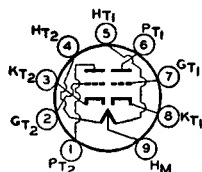

devices. Outline 14, OUTLINES SECTION. Tube requires noval nine-contact socket and may be mounted in any position. Its characteristics are similar to glass-octal type 6SL7-GT. Each triode unit is independent of the other except for the common heater. For characteristics and curves, refer to type 6AV6. For typical operation as a resistance-coupled amplifier, refer to Chart 20, RESISTANCE-COUPLED AMPLIFIER SECTION.

| HEATER ARRANGEMENT                         | <i>Series</i>     | <i>Parallel</i>   |         |
|--|-------------------|-------------------|---------|
| HEATER VOLTAGE (AC/DC).....                | 12.6              | 6.3               | volts   |
| HEATER CURRENT.....                        | 0.15              | 0.3               | ampere  |
| <b>DIRECT INTERELECTRODE CAPACITANCES:</b> |                   |                   |         |
|  | <i>Unit No. 1</i> | <i>Unit No. 2</i> |         |
| Grid to Plate.....                         | 1.7               | 1.7               | $\mu$ i |
| Grid to Cathode and Heater.....            | 1.6               | 1.6               | $\mu$ i |
| Plate to Cathode and Heater.....           | 0.46              | 0.34              | $\mu$ i |

**Maximum Ratings:**
**CLASS A<sub>1</sub> AMPLIFIER (Each Unit)**

|  |         |       |
|--|---------|-------|
| PLATE VOLTAGE.....                           | 300 max | volts |
| PLATE DISSIPATION.....                       | 1 max   | watt  |
| <b>GRID VOLTAGE:</b>                         |         |       |
| Negative bias value.....                     | 50 max  | volts |
| Positive bias value.....                     | 0 max   | volts |
| <b>PEAK HEATER-CATHODE VOLTAGE:</b>          |         |       |
| Heater negative with respect to cathode..... | 180 max | volts |
| Heater positive with respect to cathode..... | 180 max | volts |

### TRIODE—PENTODE

Glass octal type used as combined detector and rf or if amplifier in ac/dc receivers. Heater volts (ac/dc), 12.6; amperes, 0.3. Characteristics of triode unit: plate volts, 90; grid volts, 0; amplification factor, 90; plate resistance, 37000 ohms; transconductance, 2400  $\mu$ mhos; plate ma., 2.8. Characteristics of pentode unit: plate volts, 90; grid-No.2 volts, 90; grid-No.1 volts, 90; grid-No.2 ma., 2. This is a DISCONTINUED type listed for reference only.

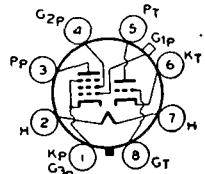

## 12B8-GT

-3; plate resistance, 20000 ohms; transconductance, 1800  $\mu$ mhos; grid-No.1 volts for transconductance of 2  $\mu$ mhos, -42.5; plate ma., 7; grid-No.2 ma., 2. This is a DISCONTINUED type listed for reference only.

### REMOTE-CUTOFF PENTODE

Miniature type used as rf amplifier in ac/dc standard broadcast receivers, in FM receivers, and in other wide-band, high-frequency applications. Outline 13, OUTLINES SECTION. Heater volts (ac/dc), 12.6; amperes, 0.15. Except for heater ratings, this type is identical with miniature type 6BA6.

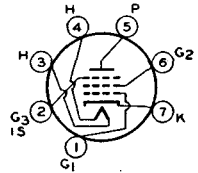

## 12BA6

### PENTAGRID CONVERTER

Miniature type used as converter in ac/dc superheterodyne circuits especially those for the FM broadcast band. Outline 17, OUTLINES SECTION. Heater volts (ac/dc), 12.6; amperes, 0.15. Except for heater rating, this type is identical with miniature type 6BA7.

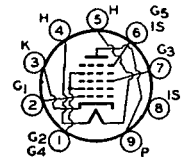

## 12BA7

peres, 0.15. Except for heater rating, this type is identical with miniature type 6BA7.

### REMOTE-CUTOFF PENTODE

Miniature type used as rf or if amplifier in radio receivers. Outline 13, OUTLINES SECTION. Heater volts (ac/dc), 12.6; amperes, 0.15. Except for heater rating, this type is identical with miniature type 6BD6.

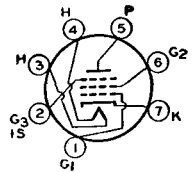

## 12BD6

### PENTAGRID CONVERTER

Miniature type used as converter in ac/dc receivers for both standard broadcast and FM bands, Outline 13, OUTLINES SECTION. Heater volts (ac/dc), 12.6; amperes, 0.15. Except for heater rating, this type is identical with miniature type 6BE6.

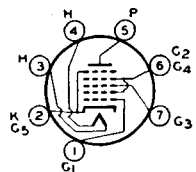

## 12BE6

**TWIN DIODE—  
MEDIUM-MU TRIODE**

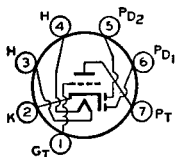

**12BF6**

Miniature type used as combined detector, amplifier, and avc tube primarily in automobile radio receivers operating from a 12-volt storage battery. The triode unit is particularly

useful as a driver for impedance- or transformer-coupled output stages in automobile receivers. It is equivalent in performance to metal type 12SR7. Outline 13, OUTLINES SECTION. Tube requires miniature seven-contact socket and may be mounted in any position. Heater volts (ac/dc), 12.6; amperes, 0.15. Except for heater rating, this type is identical with miniature type 6BF6.

**MEDIUM-MU TWIN TRIODE**

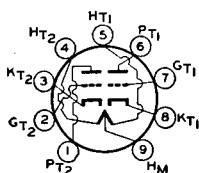

**12BH7**

Miniature type used as a combined vertical deflection amplifier and vertical oscillator, and as a horizontal deflection oscillator, in television receivers. It is also used in other appli-

cations including phase-inverter circuits and multivibrator circuits. Outline 17, OUTLINES SECTION. Tube requires noval nine-contact socket and may be mounted in any position. Each triode unit is independent of the other except for the common heater.

|  |                  |                  |               |
|--|------------------|------------------|---------------|
| <b>HEATER ARRANGEMENT</b>                            | <i>Series</i>    | <i>Parallel</i>  |               |
| HEATER VOLTAGE (AC/DC) .....                         | 12.6             | 6.3              | volts         |
| HEATER CURRENT .....                                 | 0.3              | 0.6              | ampere        |
| <b>DIRECT INTERELECTRODE CAPACITANCES (Approx.):</b> |                  |                  |               |
|  | <i>Unit No.1</i> | <i>Unit No.2</i> |               |
| Grid to Plate .....                                  | 2.6              | 2.6              | $\mu\text{f}$ |
| Grid to Cathode and Heater .....                     | 3.2              | 3.2              | $\mu\text{f}$ |
| Plate to Cathode and Heater .....                    | 0.5              | 0.4              | $\mu\text{f}$ |
| Plate of Unit No.1 to Plate of Unit No.2 .....       |                  | 0.8              | $\mu\text{f}$ |

**CLASS A<sub>1</sub> AMPLIFIER (Each Unit)**

**Maximum Ratings:**

|   |                |       |
|---|----------------|-------|
| PLATE VOLTAGE .....                           | 300 <i>max</i> | volts |
| <b>GRID VOLTAGE:</b>                          |                |       |
| Negative Bias Value .....                     | 50 <i>max</i>  | volts |
| Positive Bias Value .....                     | 0 <i>max</i>   | volts |
| CATHODE CURRENT .....                         | 20 <i>max</i>  | ma    |
| PLATE DISSIPATION .....                       | 3.5 <i>max</i> | watts |
| <b>PEAK HEATER-CATHODE VOLTAGE:</b>           |                |       |
| Heater negative with respect to cathode ..... | 200 <i>max</i> | volts |
| Heater positive with respect to cathode ..... | 200 <i>max</i> | volts |

■ The dc component must not exceed 100 volts.

**Characteristics:**

|  |       |                  |
|--|-------|------------------|
| Plate Voltage .....  | 250   | volts            |
| Grid Voltage .....   | -10.5 | volts            |
| Amplification Factor .....   | 16.5  |                  |
| Plate Resistance (Approx.) .....                                   | 5300  | ohms             |
| Transconductance .....   | 3100  | $\mu\text{mhos}$ |
| Grid Voltage (Approx.) for plate current of 50 $\mu\text{a}$ ..... | -23   | volts            |
| Plate Current .....  | 11.5  | ma               |

**Maximum Circuit Values (For maximum rated conditions):**

|                                  |                 |        |
|----------------------------------|-----------------|--------|
| <b>Grid-Circuit Resistance:</b>  |                 |        |
| For fixed-bias operation .....   | 0.25 <i>max</i> | megohm |
| For cathode-bias operation ..... | 1.0 <i>max</i>  | megohm |

## OSCILLATOR

For operation in a 525-line, 30-frame system

|  | Vertical<br>Deflection<br>Oscillator | Horizontal<br>Deflection<br>Oscillator |       |
|--|--------------------------------------|--|-------|
| <b>Maximum Ratings (Each Unit):</b>            |                                      |  |       |
| DC PLATE VOLTAGE.....                          | 450 max                              | 450 max                                | volts |
| PEAK NEGATIVE-PULSE GRID VOLTAGE.....          | -400# max                            | -600# max                              | volts |
| <b>CATHODE CURRENT:</b>                        |                                      |  |       |
| Peak.....                                      | 70 max                               | 300 max                                | ma    |
| Average.....                                   | 20 max                               | 20 max                                 | ma    |
| <b>PLATE DISSIPATION:</b>                      |                                      |  |       |
| For either plate.....                          | 3.5 max                              | 3.5 max                                | watts |
| For both plates with both units operating..... | 7.0 max                              | 7.0 max                                | watts |
| <b>PEAK HEATER-CATHODE VOLTAGE:</b>            |                                      |  |       |
| Heater negative with respect to cathode.....   | 200 max                              | 200 max                                | volts |
| Heater positive with respect to cathode.....   | 200° max                             | 200° max                               | volts |

**Maximum Circuit Value:**

|                              |         |         |         |
|------------------------------|---------|---------|---------|
| Grid-Circuit Resistance..... | 2.2 max | 2.2 max | megohms |
|------------------------------|---------|---------|---------|

## VERTICAL DEFLECTION AMPLIFIER

For operation in a 525-line, 30-frame system

**Maximum Ratings (Each Unit):**

|  |           |       |
|--|-----------|-------|
| DC PLATE VOLTAGE.....                                      | 450 max   | volts |
| PEAK POSITIVE-PULSE PLATE VOLTAGE# (Absolute maximum)..... | 1500° max | volts |
| PEAK NEGATIVE-PULSE GRID VOLTAGE.....                      | -250 max  | volts |
| <b>CATHODE CURRENT:</b>                                    |           |       |
| Peak.....  | 70 max    | ma    |
| Average.....   | 20 max    | ma    |
| <b>PLATE DISSIPATION:</b>                                  |           |       |
| For either plate.....                                      | 3.5 max   | watts |
| For both plates with both units operating.....             | 7.0 max   | watts |
| <b>PEAK HEATER-CATHODE VOLTAGE:</b>                        |           |       |
| Heater negative with respect to cathode.....               | 200 max   | volts |
| Heater positive with respect to cathode.....               | 200° max  | volts |

**Maximum Circuit Value:**

|                                 |         |         |  |
|---------------------------------|---------|---------|--|
| Grid-Circuit Resistance:        |         |         |  |
| For cathode-bias operation..... | 2.2 max | megohms |  |

# The duration of the voltage pulse must not exceed 15 per cent of one vertical scanning cycle. In a 525-line, 30-frame system, 15 per cent of one vertical scanning cycle is 2.5 milliseconds.

\* The duration of the voltage pulse must not exceed 15 per cent of one horizontal scanning cycle. In a 525-line, 30-frame system, 15 per cent of one horizontal scanning cycle is 10 milliseconds.

■ Under no circumstances should this absolute value be exceeded.

° The dc component must not exceed 100 volts.

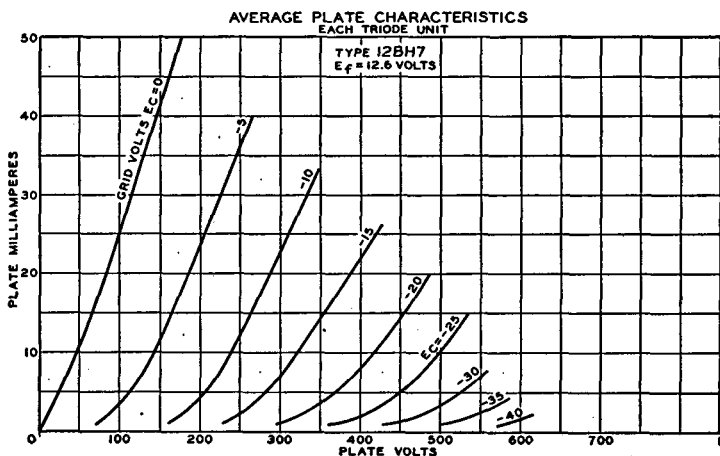

82CM-7742T

**SHARP-CUTOFF PENTODE**

Miniature type used as video amplifier in television receivers utilizing series-heater strings. Outline 17, OUTLINES SECTION. Tube requires noval nine-contact socket and may be mounted in any position.

**12BY7**

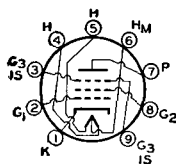

|   |        |          |               |
|---|--------|----------|---------------|
| HEATER ARRANGEMENT  | Series | Parallel |               |
| HEATER VOLTAGE (AC/DC)  | 12.6   | 6.3      | volts         |
| HEATER CURRENT  | 0.3    | 0.6      | ampere        |
| DIRECT INTERELECTRODE CAPACITANCES:                                     |        |          |               |
| Grid No.1 to Plate  |        | 0.055    | $\mu\text{f}$ |
| Grid No.1 to Cathode, Heater, Grid No.2, Grid No.3, and Internal Shield |        | 11.1     | $\mu\text{f}$ |
| Plate to Cathode, Heater, Grid No.2, Grid No.3, and Internal Shield     |        | 3.0      | $\mu\text{f}$ |

**CLASS A<sub>1</sub> AMPLIFIER**

**Maximum Ratings:**

|   |          |       |
|---|----------|-------|
| PLATE SUPPLY VOLTAGE                    | 300 max  | volts |
| GRID No.3 (SUPPRESSOR) VOLTAGE          | 0 max    | volts |
| GRID No.2 (SCREEN) VOLTAGE              | 175 max  | volts |
| GRID No.1 (CONTROL-GRID) VOLTAGE:       |          |       |
| Negative Bias Value                     | 50 max   | volts |
| Positive Bias Value                     | 0 max    | volts |
| GRID-No.2 INPUT                         | 1 max    | watt  |
| PLATE DISSIPATION                       | 6.25 max | watts |
| PEAK HEATER-CATHODE VOLTAGE:            |          |       |
| Heater negative with respect to cathode | 180 max  | volts |
| Heater positive with respect to cathode | 180 max  | volts |

**Characteristics:**

|  |                                |                  |
|--|--------------------------------|------------------|
| Plate Voltage  | 250                            | volts            |
| Grid No.3  | Connected to cathode at socket |                  |
| Grid-No.2 Voltage                                      | 150                            | volts            |
| Cathode-Bias Resistor                                  | 68                             | ohms             |
| Plate Resistance (Approx.)                             | 90000                          | ohms             |
| Transconductance                                       | 12000                          | $\mu\text{mhos}$ |
| Plate Current  | 25                             | ma               |
| Grid-No.2 Current                                      | 6                              | ma               |
| Grid-No.1 Bias for plate current of 20 $\mu\text{a}$ . | -10                            | volts            |

**Maximum Circuit Value:**

|                               |          |        |
|-------------------------------|----------|--------|
| Grid-No.1-Circuit Resistance: |          |        |
| For cathode-bias operation    | 1 max    | megohm |
| For fixed-bias operation      | 0.25 max | megohm |

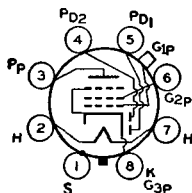

**TWIN DIODE—REMOTE-CUTOFF PENTODE**

Metal type used as combined detector, amplifier, and avc tube in ac/dc receivers. Outline 4, OUTLINES SECTION. Heater volts (ac/dc), 12.6; amperes, 0.15. Except for heater rating, this type is identical with metal type 6B8.

**12C8**

**HIGH-MU TRIODE**

Glass octal type used in resistance-coupled amplifier circuits of ac/dc receivers. Outline 21, OUTLINES SECTION. This type may be supplied with pin No.1 omitted. Heater volts (ac/dc), 12.6; amperes, 0.15. Except for heater rating, this type is identical with glass-octal type 6F5-GT. Type 12F5-GT is a DISCONTINUED type listed for reference only.

**12F5-GT**

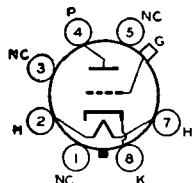

## 12H6

### TWIN DIODE

Metal type used as detector, low-voltage rectifier, or avc tube in ac/dc radio receivers. Outline 1, OUTLINES SECTION. Heater volts (ac/dc), 12.6; amperes, 0.15. Except for heater rating, this type is identical with metal type 6H6.

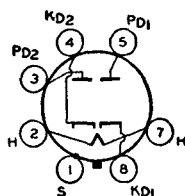

## 12J5-GT

### MEDIUM-MU TRIODE

Glass octal type used as detector, amplifier, or oscillator in ac/dc radio equipment. Outline 25, OUTLINES SECTION. This type may be supplied with pin No.1 omitted. Heater volts (ac/dc), 12.6; amperes, 0.15. Except for heater rating, this type is identical with glass-octal type 6J5-GT. Type 12J5-GT is used principally for renewal purposes.

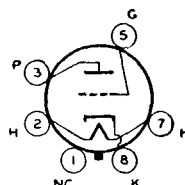

## 12J7-GT

### SHARP-CUTOFF PENTODE

Glass octal type used as biased detector or high-gain audio amplifier in ac/dc radio receivers. Outline 24, OUTLINES SECTION. Heater volts (ac/dc), 12.6; amperes, 0.15. Except for heater rating, this type is identical with glass-octal type 6J7-GT. Type 12J7-GT is used principally for renewal purposes.

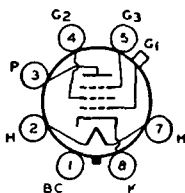

## 12K7-GT

### REMOTE-CUTOFF PENTODE

Glass octal type used as rf or if amplifier in ac/dc radio receivers particularly those employing avc. Outline 24, OUTLINES SECTION. Heater volts (ac/dc), 12.6; amperes, 0.15. Except for heater rating, this type is identical with glass-octal type 6K7-GT. Type 12K7-GT is used principally for renewal purposes.

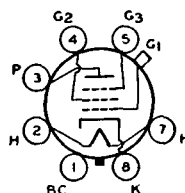

## 12K8

### TRIODE—HEXODE CONVERTER

Metal type used as combined triode oscillator and hexode mixer in ac/dc radio receivers. Outline 5, OUTLINES SECTION. Heater volts (ac/dc), 12.6; amperes, 0.15. Except for heater rating, this type is identical with metal type 6K8.

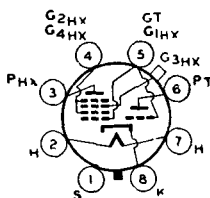

## 12Q7-GT

### TWIN DIODE—HIGH-MU TRIODE

Glass octal type used as combined detector, amplifier, and avc tube in ac/dc radio receivers. Outline 24, OUTLINES SECTION. Heater volts (ac/dc), 12.6; amperes, 0.15. Except for heater rating, this type is identical with glass-octal type 6Q7-GT. Type 12Q7-GT is used principally for renewal purposes.

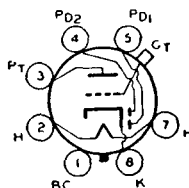

**TRIPLE DIODE—HIGH-MU TRIODE**

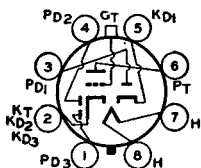

Glass octal type used as audio amplifier, AM detector, and FM detector in AM/FM receivers. Outline 28, OUTLINES SECTION. Heater volts (ac/dc), 12.6; amperes, 0.15. Except for heater rating, this type is identical with glass octal type 6S8-GT. Type 12S8-GT is a DISCONTINUED type listed for reference only.

**12S8-GT**

**PENTAGRID CONVERTER**

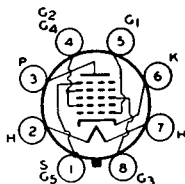

Metal type 12SA7 and glass-octal type 12SA7-GT used as converter in ac/dc receivers. Outlines 3 and 23, respectively, OUTLINES SECTION. Heater volts (ac/dc), 12.6; amperes, 0.15. Except for heater ratings, type 12SA7 is identical with metal type 6SA7, and type 12SA7-GT is identical with glass-octal type 6SA7-GT.

**12SA7**

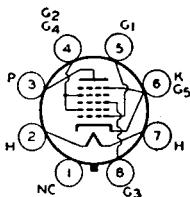

**12SA7-GT**

**HIGH-MU TWIN TRIODE**

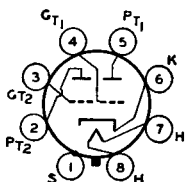

Metal type used as phase inverter or voltage amplifier in ac/dc radio equipment. Outline 3, OUTLINES SECTION. Heater volts (ac/dc), 12.6; amperes, 0.15. Except for heater rating, this type is identical with metal type 6SC7.

**12SC7**

**HIGH-MU TRIODE**

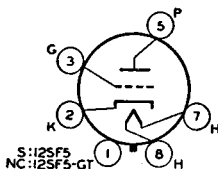

Metal type 12SF5 and glass-octal type 12SF5-GT used in resistance-coupled amplifier circuits of ac/dc radio equipment. Outlines 3 and 23, respectively, OUTLINES SECTION. Type 12SF5-GT may be supplied with pin No. omitted. Heater volts (ac/dc), 12.6; amperes, 0.15. Except for heater rating, type 12SF5 is identical with metal type 6SF5, and type

**12SF5**  
**12SF5-GT**

12SF5-GT is identical with glass-octal type 6SF5-GT. Type 12SF5-GT is a DISCONTINUED type listed for reference only.

**DIODE—  
REMOTE-CUTOFF PENTODE**

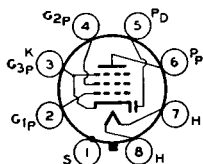

Metal type used as combined rf or if amplifier and detector or avc tube in ac/dc radio receivers. Outline 3, OUTLINES SECTION. Heater volts (ac/dc), 12.6; amperes, 0.15. Except for heater rating, this type is identical with metal type 6SF7.

**12SF7**

**REMOTE-CUTOFF PENTODE**

**12SG7**

Metal type used as rf amplifier in ac/dc receivers involving high-frequency, wide-band applications. Outline 3, OUTLINES SECTION. Heater volts (ac/dc), 12.6; amperes, 0.15. Except for heater rating, this type is identical with metal type 6SG7.

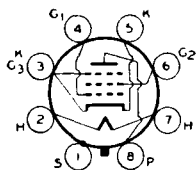

**SHARP-CUTOFF PENTODE**

**12SH7**

Metal type used as rf amplifier in ac/dc receivers involving high-frequency, wide-band applications and as limiter tube in FM equipment. Outline 3, OUTLINES SECTION. Heater volts (ac/dc), 12.6; amperes, 0.15. Except for heater rating, this type is identical with metal type 6SH7.

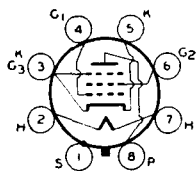

**SHARP-CUTOFF PENTODE**

**12SJ7  
12SJ7-GT**

Metal type 12SJ7 and glass-octal type 12SJ7-GT used as rf amplifiers and biased detectors in ac/dc radio receivers. Outlines 3 and 25, respectively, OUTLINES SECTION.

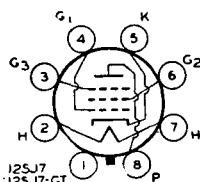

Heater volts (ac/dc), 12.6; amperes, 0.15. Except for heater rating, type 12SJ7 is identical with metal type 6SJ7, and type 12SJ7-GT is identical with glass-octal type 6SJ7-GT. Type 12SJ7-GT is a DISCONTINUED type listed for reference only.

**REMOTE-CUTOFF PENTODE**

**12SK7  
12SK7-GT**

Metal type 12SK7 and glass-octal type 12SK7-GT used as rf and if amplifiers in ac/dc radio receivers. Outlines 3 and 25, respectively, OUTLINES SECTION. Heater volts

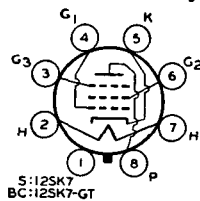

(ac/dc), 12.6; amperes, 0.15. Except for heater rating, type 12SK7 is identical with metal type 6SK7, and type 12SK7-GT is identical with glass-octal type 6SK7-GT. Type 12SK7-GT is used principally for renewal purposes.

**HIGH-MU TWIN TRIODE**

**12SL7-GT**

Glass octal type used as phase inverter or resistance-coupled amplifier in ac/dc radio equipment. Outline 23, OUTLINES SECTION. Heater volts (ac/dc), 12.6; amperes, 0.15. Except for heater rating, this type is identical with glass-octal type 6SL7-GT.

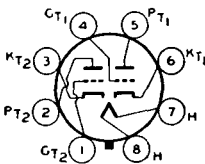

**MEDIUM-MU TWIN TRIODE**

**12SN7-GT**

Glass octal type used as phase inverter or resistance-coupled amplifier in ac/dc radio equipment. Outline 23, OUTLINES SECTION. Heater volts (ac/dc), 12.6; amperes, 0.3. Except for heater rating, this type is identical with glass-octal type 6SN7-GT.

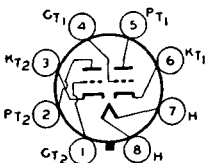



**TWIN DIODE—  
HIGH-MU TRIODE**

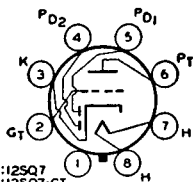

S:12SQ7  
BC:12SQ7-GT

Heater volts (ac/dc), 12.6; amperes, 0.15. Except for heater rating, type 12SQ7 is identical with metal type 6SQ7, and type 12SQ7-GT is identical with glass-octal type 6SQ7-GT.

**12SQ7  
12SQ7-GT**

**TWIN DIODE—MEDIUM-MU TRIODE**

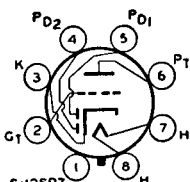

S:12SR7  
BC:12SR7-GT

is a DISCONTINUED type listed for reference only. Both types are similar in performance to miniature type 6BF6.

**12SR7  
12SR7-GT**

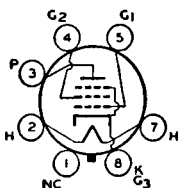

**BEAM POWER TUBE**

Glass octal type used as output amplifier primarily in automobile radio receivers operating from a 12-volt storage battery. Outline 23, OUTLINES SECTION. Tube requires octal socket

**12V6-GT**

and may be mounted in any position. Heater volts (ac/dc), 12.6; amperes, 0.15. Except for heater rating, this type is identical with glass octal type 6V6-GT.

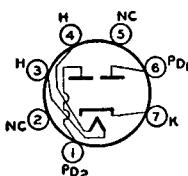

**FULL-WAVE VACUUM RECTIFIER**

Miniature type used in power supply of automobile radio receivers operating from a 12-volt storage battery. Outline 16, OUTLINES SECTION. Heater volts (ac/dc), 12.6; am-

**12X4**

peres, 0.225. Except for heater rating, this type is identical with miniature type 6X4.

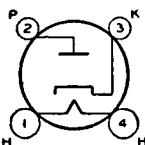

**HALF-WAVE VACUUM RECTIFIER**

Glass types used in power supply of ac/dc receivers. Outline 31 or 34, OUTLINES SECTION. Tube requires four-contact socket and may be mounted in any position. It is especially important that this tube, like other power-handling tubes, should be adequately ventilated. Use of capacitor-input filter recommended in order to obtain as high a dc output voltage as

**12Z3**

possible. Heater volts (ac/dc), 12.6; amperes, 0.3. Maximum ratings as half-wave rectifier: peak in verse plate volts, 700 max; peak plate ma., 330 max; dc output ma., 55 max; peak heater-cathode volts, 350 max. With typical operating ac plate voltages of 117, 150, and 235 volts rms, the minimum total effective plate-supply impedance required is 0, 30, and 75 ohms, respectively. This is a DISCONTINUED type listed for reference only.

**MEDIUM-MU TRIODE**

Glass lock-in type used as detector, amplifier, or oscillator in ac/dc radio receivers. Outline 15, OUTLINES SECTION. Tube requires lock-in socket. Heater volts (ac/dc), 12.6; amperes, 0.15. Except for heater rating and capacitances, this type is electrically identical with lock-in type 7A4 and metal type 6J5. The application of this type is similar to that of glass-octal type 12J5-GT. Type 14A4 is a DISCONTINUED type listed for reference only.

**14A4**

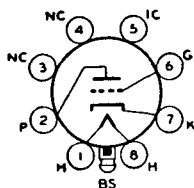

**BEAM POWER TUBE**

Glass lock-in type used as output amplifier in ac/dc radio receivers. Outline 15, OUTLINES SECTION. Tube requires lock-in socket. Heater volts (ac/dc), 12.6; amperes, 0.15. Typical operation and ratings as class A<sub>1</sub> amplifier: plate volts and grid-No.2 volts, 250 (300 max); plate dissipation, 7.5 watts; grid-No.2 input, 1.5 watts; grid-No.1 volts, -12.5; plate ma., 32;

grid-No.2 ma., 5.5; plate resistance, 70000 ohms; transconductance, 3000  $\mu$ mbos; load resistance, 7500 ohms; output watts, 2.8. This is a DISCONTINUED type listed for reference only.

**14A5**

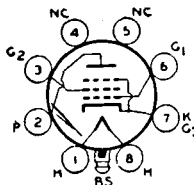

**REMOTE-CUTOFF PENTODE**

Glass lock-in type used as rf or if amplifier in ac/dc radio receivers. Outline 15, OUTLINES SECTION. Tube requires lock-in socket. Heater volts (ac/dc), 12.6; amperes, 0.15. Except for heater rating and capacitances, this type is electrically identical with metal type 6SK7 and lock-in type 7A7. The application of this type is similar to that of metal type 12SK7.

**14A7**

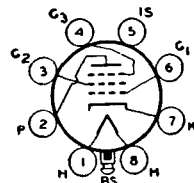

**MEDIUM-MU TWIN TRIODE**

Glass lock-in type used as voltage amplifier or phase inverter in radio equipment. Outline 15, OUTLINES SECTION. Tube requires lock-in socket. Heater volts (ac/dc), 12.6; amperes, 0.15. Except for heater ratings, this type is electrically identical with lock-in type 7AF7.

**14AF7**

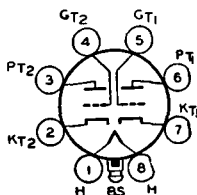

**TWIN DIODE—HIGH-MU TRIODE**

Glass lock-in type used as combined detector, amplifier, and avc tube in ac/dc radio receivers. Outline 15, OUTLINES SECTION. Tube requires lock-in socket. Heater volts (ac/dc), 12.6; amperes, 0.15. Except for heater rating and capacitances, this type is electrically identical with lock-in type 7B6 and metal type 6SQ7. The application of this type is similar to that of metal type 12SQ7.

**14B6**

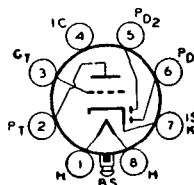

**PENTAGRID CONVERTER**

Glass lock-in type used as converter in ac/dc radio receivers. Outline 15, OUTLINES SECTION. Tube requires lock-in socket. Heater volts (ac/dc), 12.6; amperes, 0.15. Except for heater rating and capacitances, this type is electrically identical with lock-in type 7B8 and metal type 6A8. The application of this type is similar to that of glass-octal type 12A8-GT. Type 14B8 is used principally for renewal purposes.

**14B8**

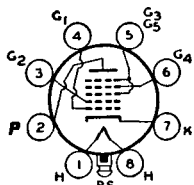

**BEAM POWER TUBE**

Glass lock-in type used as output amplifier in ac/dc radio receivers. Outline 20, OUTLINES SECTION. Tube requires lock-in socket. Heater volts (ac/dc), 12.6; amperes, 0.225. Except for heater rating, this type is electrically identical with lock-in type 7C5 and metal type 6V6. Type 14C5 is used principally for renewal purposes.

**14C5**

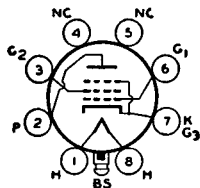

**SHARP-CUTOFF PENTODE**

Glass lock-in type used as rf amplifier and biased detector in ac/dc radio receivers. Outline 15, OUTLINES SECTION. Tube requires lock-in socket. Heater volts (ac/dc), 12.6; amperes, 0.15. Typical operation and maximum ratings as class A<sub>1</sub> amplifier: plate volts, 250 (300 max); grid-No.2 volts, 100; plate dissipation, 1 maz watt; grid-No.2 input, 0.1

**14C7**

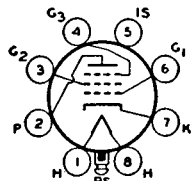

maz watt; grid No.1 volts, -3; grid No.3 connected to cathode at socket; plate resistance, greater than 1 megohm; transconductance, 1575  $\mu$ mhos; plate ma., 2.2; grid-No.2 ma., 0.7. Within the limits of its maximum ratings, this type is similar in performance to metal types 6SJ7 and 12SJ7.

**TWIN DIODE—MEDIUM-MU TRIODE**

Glass lock-in type used as combined detector, amplifier, and avc tube in ac/dc radio receivers. Outline 15, OUTLINES SECTION. Tube requires lock-in socket. Heater volts, (ac/dc), 12.6; amperes, 0.15. Except for heater rating, this type is electrically identical with lock-in type 7E6 and miniature type 6BF6. The application of this type is similar to that of metal type 12SR7. Type 14E6 is a DISCONTINUED type listed for reference only.

**14E6**

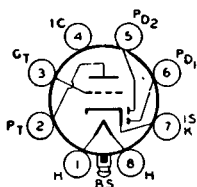

**TWIN DIODE—REMOTE-CUTOFF PENTODE**

Glass lock-in type used as combined detector, amplifier, and avc tube in ac/dc receivers. Outline 15, OUTLINES SECTION. Tube requires lock-in socket. Heater volts (ac/dc), 12.6; amperes, 0.15. Except for heater rating, this type is electrically identical with lock-in type 7E7. Type 14E7 is a DISCONTINUED type listed for reference only.

**14E7**

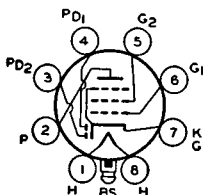

**HIGH-MU TWIN TRIODE**

Glass lock-in type used as phase inverter or resistance-coupled amplifier in ac/dc radio receivers. Outline 15, OUTLINES SECTION. Tube requires lock-in socket. Heater volts (ac/dc), 12.6; amperes, 0.15. Except for heater rating, this type is electrically identical with lock-in type 7F7 and glass-octal type 6SL7-GT. The application of this type is similar to that of glass-octal type 12SL7-GT.

**14F7**

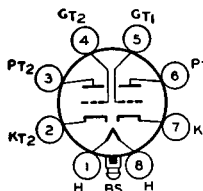

**MEDIUM-MU TWIN TRIODE**

Glass lock-in type used as amplifier or oscillator in ac/dc radio equipment. Outline 11, OUTLINES SECTION. Tube requires lock-in socket. Heater volts (ac/dc), 12.6; amperes, 0.15. Except for heater rating, this type is electrically identical with lock-in type 7F8.

**14F8**

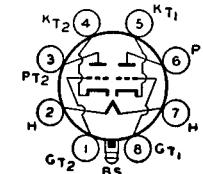

**REMOTE-CUTOFF PENTODE**

**14H7**

Glass lock-in type used as rf or if amplifier in ac/dc radio receivers. Outline 15, OUTLINES SECTION. Tube requires lock-in socket. Heater volts (ac/dc), 12.6; amperes, 0.15. Except for heater rating, this type is electrically identical with lock-in type 7H7. The application of this type is similar to that of miniature type 12BA6. Type 14H7 is used principally for renewal purposes.

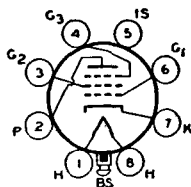

**TRIODE—HEPTODE CONVERTER**

**14J7**

Glass lock-in type used as combined triode oscillator and heptode mixer in ac/dc radio receivers. Outline 15, OUTLINES SECTION. Tube requires lock-in socket. Heater volts (ac/dc), 12.6; amperes, 0.15. Except for heater rating, this type is electrically identical with lock-in type 7J7. Type 14J7 is a DISCONTINUED type listed for reference only.

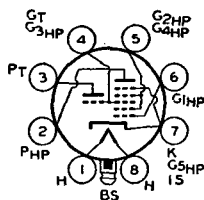

**MEDIUM-MU TWIN TRIODE**

**14N7**

Glass lock-in type used as voltage amplifier or phase inverter in ac/dc radio equipment. Outline 20, OUTLINES SECTION. Tube requires lock-in socket. Heater volts (ac/dc), 12.6; amperes, 0.3. Except for heater rating and capacitances, this type is electrically identical with lock-in type 7N7 and glass-octal type 6SN7-GT. The application of this type is similar

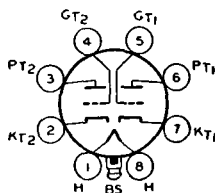

lar to that of glass-octal type 12SN7-GT. Type 14N7 is a DISCONTINUED type listed for reference only.

**PENTAGRID CONVERTER**

**14Q7**

Glass lock-in type used as converter in ac/dc radio receivers. Outline 15, OUTLINES SECTION. Tube requires lock-in socket. Heater volts (ac/dc), 12.6; amperes, 0.15. Except for heater ratings and capacitances, this type is electrically identical with metal type 6SA7 and lock-in type 7Q7. The application of this type is similar to that of metal type 12SA7.

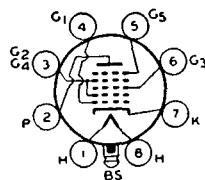

**TWIN DIODE—  
REMOTE-CUTOFF PENTODE**

**14R7**

Glass lock-in type used as combined detector, amplifier, and avc tube in ac/dc radio receivers. Outline 15, OUTLINES SECTION. Tube requires lock-in socket. Heater volts (ac/dc), 12.6; amperes, 0.15. Except for heater rating, this type is electrically identical with lock-in type 7R7.

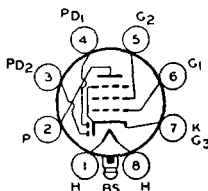

**SHARP-CUTOFF PENTODE**

**15**

Glass type used as rf amplifier in battery-operated receivers. Outline 36, OUTLINES SECTION. Tube requires five-contact socket. Heater volts (dc), 2.0; amperes, 0.22. Typical operation as class A<sub>1</sub> amplifier: plate volts, 135 max; grid-No.2 (screen) volts, 67.5 max; grid-No.1 volts, -1.5; plate ma., 1.86; grid-No.2 ma., 0.3; plate resistance, 0.80 megohm; transconductance, 750 μmhos. This is a DISCONTINUED type listed for reference only.

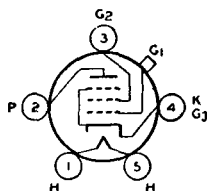

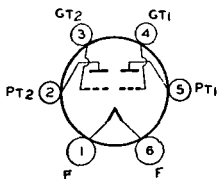

**HIGH-MU TWIN POWER TRIODE**

Glass type used in output stage of battery-operated receivers. Outline 31 or 34, OUTLINES SECTION. Tube requires six-contact socket. Filament volts (dc), 2.0; amperes, 0.26. Except for filament current, this type is electrically identical with type 1J6-GT. Type 19 is a DISCONTINUED type listed for reference only.

19

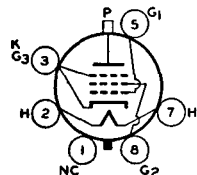

**BEAM POWER TUBE**

Glass octal type used as output amplifier in horizontal deflection circuits of television equipment of the "transformerless" type where high pulse voltages occur during short-duty cycles. Outline 44, OUTLINES SECTION. Tube requires octal socket. Vertical tube mounting is preferred but horizontal operation is permissible if pins No.2 and 7 are in vertical plane. Heater

19BG6-G

volts (ac/dc), 19.8; amperes, 0.3. Except for heater rating and peak heater-cathode voltage rating of 250 volts with heater either negative or positive with respect to cathode, this type is identical with glass octal type 6BG6-G. Type 19BG6-G is used principally for renewal purposes.

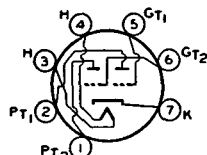

**MEDIUM-MU TWIN TRIODE**

Miniature type used for converter service in ac/dc AM and FM receivers and as oscillator, amplifier, or mixer in television receivers of the "transformerless" type. Outline 13, OUTLINES SECTION. Tube requires miniature seven-contact socket and may be mounted in any position. For direct interelectrode capacitances, ratings, and typical operation as a class

19J6

A<sub>1</sub> amplifier, and curves, refer to type 6J6. Type 19J6 is used principally for renewal purposes.

|                             |      |        |
|-----------------------------|------|--------|
| HEATER VOLTAGE (AC/DC)..... | 18.9 | volts  |
| HEATER CURRENT.....         | 0.15 | ampere |

**Maximum Ratings:**

**MIXER SERVICE (Each Unit)**

|  |         |       |
|--|---------|-------|
| PLATE VOLTAGE.....                           | 300 max | volts |
| PLATE DISSIPATION.....                       | 1.5 max | watts |
| PEAK HEATER-CATHODE VOLTAGE:                 |         |       |
| Heater negative with respect to cathode..... | 90 max  | volts |
| Heater positive with respect to cathode..... | 90 max  | volts |

**Typical Operation and Characteristics:**

|                                  |       |       |
|----------------------------------|-------|-------|
| Plate Voltage.....               | 150   | volts |
| Cathode-Bias Resistor.....       | 810   | ohms  |
| Peak Oscillator Voltage.....     | 3     | volts |
| Plate Resistance.....            | 10200 | ohms  |
| Conversion Transconductance..... | 1900  | μmhos |
| Plate Current.....               | 4.8   | ma    |

**Maximum Circuit Value (For maximum rated conditions):**

|                                 |                 |        |
|---------------------------------|-----------------|--------|
| Grid-Circuit Resistance:        |                 |        |
| For fixed-bias operation.....   | Not recommended |        |
| For cathode-bias operation..... | 0.5 max         | megohm |

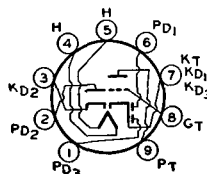

**TRIPLE DIODE-HIGH-MU TRIODE**

Miniature type used as combined audio amplifier, AM detector, and FM detector in AM/FM receivers of the a/c or "transformer" type. Outline 15, OUTLINES SECTION. Tube requires noval nine-contact socket and may be mounted in any position. Heater volts (ac/dc), 19.9; amperes, 0.15. Except for heater rating, this type is identical with miniature type 6T8. Type 19T8 is used principally for renewal purposes.

19T8

ing, this type is identical with miniature type 6T8. Type 19T8 is used principally for renewal purposes.

TRIODE-PENTODE CONVERTER

19X8

Miniature type used as combined oscillator and mixer tube in "transformerless" AM/FM receivers. Outline 14, OUTLINES SECTION. Tube requires noval nine-contact socket and may be mounted in any position. Heater volts (ac/dc), 18.9; amperes, 0.15. Except for heater rating, this type is identical with miniature type 6X8. Type 19X8 is used principally for renewal purposes.

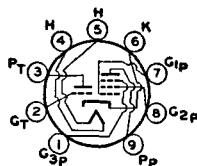

20

POWER TRIODE

Glass type used as output amplifier in dry-battery-operated receivers. Filament volts (dc), 3.3; amperes, 0.132. Characteristics as class A<sub>1</sub> amplifier: plate volts, 135 max; grid volts, -22.5; plate ma., 6.5; plate resistance, 6300 ohms; amplification factor, 3.3; transconductance, 525 μmhos; load resistance, 6500 ohms; output mw., 110. This is a DISCONTINUED type listed for reference only.

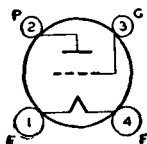

SHARP-CUTOFF TETRODE

Glass type used as rf amplifier in dry-battery-operated receivers. Outline 41, OUTLINES SECTION. Filament volts (dc), 3.3; amperes, 0.132. Characteristics as class A<sub>1</sub> amplifier: plate volts, 135 max; grid-No.2 (screen) volts, 67.5 max; grid-No.1 volts, -1.5; plate ma., 3.7; grid-No.2 ma., 1.3; plate resistance, 325000 ohms; transconductance, 500 μmhos. This is a DISCONTINUED type listed for reference only.

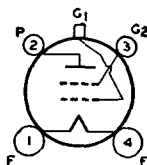

22

SHARP-CUTOFF TETRODE

Glass type used as rf amplifier or biased detector in ac-operated receivers. Outline 41, OUTLINES SECTION. Tube requires five-contact socket. Heater volts (ac/dc), 2.5; amperes, 1.75. Typical operation and maximum ratings as class A<sub>1</sub> amplifier: plate volts, 250 (275 max); grid-No.2 volts, 90; grid-No.1 volts, -3; plate resistance, 0.6 megohm; trans-

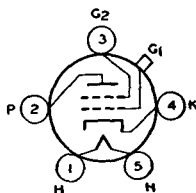

24-A

conductance, 1050 μmhos; plate ma., 4; grid-No.2 ma., 1.7 max. This type is used principally for renewal purposes.

POWER PENTODE

Metal type 25A6 and glass-octal type 25A6-GT are used in output stage of ac/dc receivers. Outlines 6 and 23, respectively, OUTLINES SECTION. Type 25A6-GT may be supplied with pin No.1 omitted. Tubes require octal socket and may be mounted in any position. Heater volts (ac/dc), 25; amperes, 0.3. Maximum ratings as class A<sub>1</sub> amplifier: plate

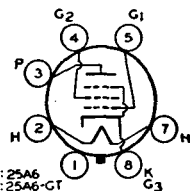

25A6  
25A6-GT

volts, 160; grid-No.2 volts, 135; plate dissipation, 5.3 watts; grid-No.2 input, 1.9 watts. Type 25A6 is used principally for renewal purposes. Type 25A6-GT is a DISCONTINUED type listed for reference only.

RECTIFIER—POWER PENTODE

Glass octal type used as combined half-wave rectifier and power amplifier. Outline 23, OUTLINES SECTION. Heater volts (ac/dc), 25; amperes, 0.3. Typical operation of pentode unit as class A<sub>1</sub> amplifier: plate volts and grid-No.2 volts, 100 (117 max); grid-No.1 volts, -15; plate ma., 20.5; grid-No.2 ma., 4; plate resistance, 50000 ohms, transconductance, 1800

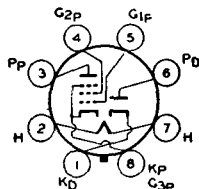

25A7-GT

μmhos; load resistance, 4500 ohms; output watts, 0.77. Maximum ratings of rectifier unit: peak inverse plate volts, 350; peak plate ma., 450; dc output ma., 75; peak heater-cathode volts, 175. This is a DISCONTINUED type listed for reference only.

**HIGH-MU POWER TRIODE**

Glass octal type used in output stage of ac/dc receivers. Outline 23, OUTLINES SECTION. This type may be supplied with pin No.1 omitted. Heater volts (ac/dc), 25; amperes, 0.3. Maximum ratings: plate volts, 180 *max*; plate dissipation, 10 *max* watts. This is a DISCONTINUED type listed for reference only.

**25AC5-GT**

**DIRECT-COUPLED POWER AMPLIFIER**

Glass type used as class A<sub>1</sub> power amplifier. One triode, the driver, is directly connected within the tube to the second, or output, triode. Heater volts (ac/dc), 25; amperes, 0.3. Maximum ratings and characteristics are the same as for type 25N6-G. Type 25B5 is a DISCONTINUED type listed for reference only.

**25B5**

**POWER PENTODE**

Glass octal type used in output stage of ac/dc receivers. Outline 37, OUTLINES SECTION. Heater volts (ac/dc), 25; amperes, 0.3. Typical operation as class A<sub>1</sub> amplifier: plate volts, 200 *max*; grid-No.2 volts, 135 *max*; grid-No.1 volts, -23; plate ma., 62; grid-No.2 ma., 1.8; plate resistance, 18000 ohms; transconductance, 5000  $\mu$ hos; load resistance, 2500 ohms; output watts, 7.1. This is a DISCONTINUED type listed for reference only.

**25B6-G**

**TRIODE—PENTODE**

Glass octal type used as amplifier. High-mu triode unit and remote-cutoff pentode unit are independent. Outline 23, OUTLINES SECTION. Heater volts (ac/dc), 25; amperes, 0.15. Typical operation of pentode unit as class A<sub>1</sub> amplifier: plate volts and grid-No.2 volts, 100; grid-No.1 volts, -3; plate ma., 7.6; grid-No.2 ma., 2; plate resistance, 185000 ohms; transconductance, 2000  $\mu$ hos; grid-No.1 volts for transconductance of 2  $\mu$ hos, -41. Triode unit: plate volts, 100; grid volts, -1; plate ma., 0.6; amplification factor, 112; plate resistance, 75000; transconductance, 1500  $\mu$ hos. This is a DISCONTINUED type listed for reference only.

**25B8-GT**

**BEAM POWER TUBE**

Glass octal type used as horizontal deflection amplifier in circuits of television equipment of the "transformerless" type. Outline 29, OUTLINES SECTION. Type 25BQ6-GT

**25BQ6-GT**

may be supplied with pin No.1 omitted. Tube requires octal socket and may be mounted in any position. Heater volts (ac/dc), 25; amperes, 0.3. Except for heater rating, this type is identical with glass octal type 6BQ6-GT.

**BEAM POWER TUBE**

Glass octal type used as output amplifier. Outline 37, OUTLINES SECTION. Heater volts (ac/dc), 25; amperes, 0.3. Refer to type 6Y6-G for typical operation as a class A<sub>1</sub> amplifier. Type 25C6-G is a DISCONTINUED type listed for reference only.

**25C6-G**

# 25L6 25L6-GT

## BEAM POWER TUBE

Metal type 25L6 and glass-octal type 25L6-GT are used in output stage of ac/dc receivers. Outlines 6 and 23, respectively, **OUTLINES SECTION**. These tubes require octal sockets and

may be mounted in any position. Type 25L6-GT may be supplied with pin No.1 omitted. Heater volts (ac/dc), 25; amperes, 0.3. For maximum ratings and typical operation, refer to type 50L6-GT. Refer to miniature type 50C5 for curves, installation, and application information, but take into consideration the differences in heater ratings.

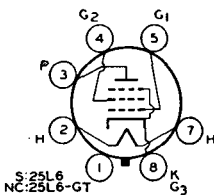

## DIRECT-COUPLED TWIN POWER AMPLIFIER

Glass octal type used as class A<sub>1</sub> power amplifier. One triode, the driver, is directly connected within the tube to the second, or output, triode. Heater volts (ac/dc), 25; amperes, 0.3. Characteristics as class A<sub>1</sub> amplifier—input triode: plate volts, 100 (180 max); grid volts, 0; peak af grid volts, 29.7; plate ma., 5.8. Output triode: plate volts, 180 max; plate ma., 46; load resistance, 4000 ohms; output watts, 3.8. This is a **DISCONTINUED** type listed for reference only.

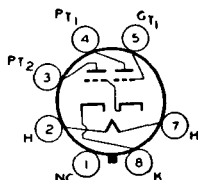

# 25N6-G

## HALF-WAVE VACUUM RECTIFIER

Glass octal type used as damper diode in magnetic deflection circuit of television receivers and as a rectifier in conventional power-supply applications. Outline 22, **OUTLINES SECTION**. This type may be supplied with pin No.1 omitted. Heater volts (ac/dc), 25; amperes, 0.3. Except for heater rating and, in damperservice, a peak inverse plate voltage rating of 2000 max

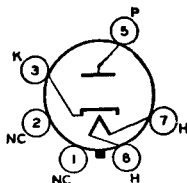

# 25W4-GT

volts and a peak heater-cathode voltage rating of 450 max volts with heater negative with respect to cathode, this type is identical with glass octal type 6W4-GT. Type 25W4-GT is used principally for renewal purposes.

## VACUUM RECTIFIER-DOUBLER

Glass type used as half-wave rectifier or voltage doubler in ac/dc receivers. Outline 31 or 34, **OUTLINES SECTION**. Heater volts (ac/dc), 25; amperes, 0.3. Maximum ratings: peak inverse plate volts, 700; peak plate ma. per plate, 450; peak heater-cathode volts, 350; dc output ma. per plate, 75. This is a **DISCONTINUED** type listed for reference only.

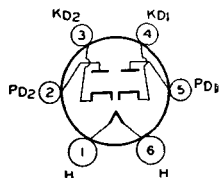

# 25Y5

## VACUUM RECTIFIER-DOUBLER

Glass type used as half-wave rectifier or voltage doubler in ac/dc receivers. For voltage-doubler considerations, refer to **ELECTRON TUBE APPLICATIONS SECTION**. Outline 31 or 34, **OUTLINES SECTION** Tube requires six-contact socket and may be mounted in any position. Heater volts (ac/dc), 25; amperes, 0.3. This type is electrically identical with metal type 25Z6. Type 25Z5 is used principally for renewal purposes.

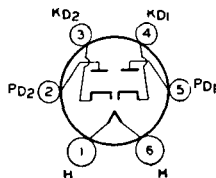

# 25Z5



**VACUUM RECTIFIER-DOUBLER**

Metal type 25Z6 and glass-octal type 25Z6-GT used as half-wave rectifiers or voltage-doublers in ac/dc receivers. These types are used particularly in "transformerless" receivers of either the ac/dc type or the voltage-doubler type. Outlines 6 and 23, respectively, OUTLINES SECTION. Type 25Z6-GT may be supplied with pin No. 1 omitted. Tubes require octal socket and may be mounted in any position. These types are used principally for renewal purposes.

**25Z6**  
**25Z6-GT**

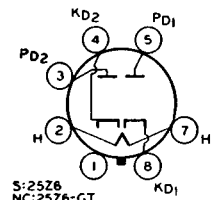

S:25Z6  
NC:25Z6-GT

|                              |     |        |
|------------------------------|-----|--------|
| HEATER VOLTAGE (AC/DC) ..... | 25  | volts  |
| HEATER CURRENT .....         | 0.3 | ampere |

**Maximum Ratings:**

**HALF-WAVE RECTIFIER**

|                                    |                |       |
|------------------------------------|----------------|-------|
| PEAK INVERSE PLATE VOLTAGE .....   | 700 <i>max</i> | volts |
| PEAK PLATE CURRENT PER PLATE ..... | 450 <i>max</i> | ma    |
| DC OUTPUT CURRENT PER PLATE .....  | 75 <i>max</i>  | ma    |
| PEAK HEATER-CATHODE VOLTAGE .....  | 350 <i>max</i> | volts |

**Typical Operation (Capacitor-Input Filter):°**

(Unless otherwise indicated, values are for both plates in parallel.)

|  |     |     |     |       |
|--|-----|-----|-----|-------|
| AC Plate-Supply Voltage per Plate (rms) .....                | 117 | 150 | 235 | volts |
| Filter-Input Capacitor .....                                 | 16  | 16  | 16  | μf    |
| Min. Total Effective Plate-Supply Impedance per Plate† ..... | 15  | 40  | 100 | ohms  |
| DC Output Current per Plate .....                            | 75  | 75  | 75  | ma    |
| DC Output Voltage At Input to Filter (Approx.):              |     |     |     |       |
| At half-load current (75 ma.) .....                          | 115 | -   | 255 | volts |
| At full-load current (150 ma.) .....                         | 80  | -   | 200 | volts |
| Voltage Regulation (Approx.):                                |     |     |     |       |
| Half-load to full-load current .....                         | 35  | -   | 55  | volts |

**Maximum Ratings:**

**VOLTAGE DOUBLER**

(Same as for Half-Wave Rectifier.)

**Typical Operation:**

|  | <i>Half-Wave</i> | <i>Full-Wave</i> |       |
|--|------------------|------------------|-------|
| AC Plate-Supply Voltage per Plate (rms) .....                | 117              | 117              | volts |
| Filter-Input Capacitor (Each) .....                          | 16               | 16               | μf    |
| Min. Total Effective Plate-Supply Impedance per Plate† ..... | 30               | 15               | ohms  |
| DC Output Current .....                                      | 75               | 75               | ma    |

° In half-wave rectifier service, the two units may be used separately or in parallel.

† When a filter-input capacitor larger than 40 μf is used, it may be necessary to use more plate-supply impedance than the minimum value shown to limit the peak plate current to the rated value.

**MEDIUM-MU TRIODE**

Glass type used as rf voltage amplifier in ac-operated receivers. Outline 38, OUTLINES SECTION. Tube requires four-contact socket. Filament volts (ac/dc), 1.5; amperes, 1.05. Typical operation as class A<sub>1</sub> amplifier: plate volts, 180 *max*; grid volts, -14.5, plate ma., 6.2; plate resistance, 7300 ohms; transconductance, 1150 μmhos; amplification factor, 8.3. This is a DISCONTINUED type listed for reference only.

**26**

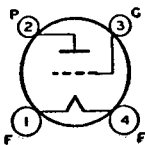

**MEDIUM-MU TRIODE**

Glass type used as voltage amplifier or detector in ac-operated receivers. Outline 31 or 34, OUTLINES SECTION. Tube requires five-contact socket. Heater volts (ac/dc), 2.5; amperes, 1.75. This type is used principally for renewal purposes.

**27**

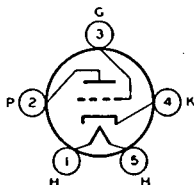

**Characteristics:**
**CLASS A<sub>1</sub> AMPLIFIER**

|                                    |       |      |       |      |       |
|------------------------------------|-------|------|-------|------|-------|
| Plate Voltage (275 volts max)..... | 90    | 135  | 180   | 250  | volts |
| Grid Voltage.....                  | -6    | -9   | -13.5 | -21  | volts |
| Amplification Factor.....          | 9     | 9    | 9     | 9    |       |
| Plate Resistance.....              | 11000 | 9000 | 9000  | 9250 | ohms  |
| Transconductance.....              | 820   | 1000 | 1000  | 975  | μmhos |
| Plate Current.....                 | 2.7   | 4.5  | 5.0   | 5.2  | ma    |

**MEDIUM-MU TRIODE**
**30**

Glass type used as voltage amplifier or detector in battery-operated receivers. Outline 31 or 34, **OUTLINES SECTION**. Tube requires four-contact socket. Filament volts (dc), 2.0; amperes, 0.06. Except for interelectrode capacitances, this type is electrically identical with glass-octal type 1H4-G. Type 30 is a **DISCONTINUED** type listed for reference only.

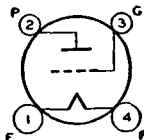
**POWER TRIODE**
**31**

Glass type used in output stage of battery-operated receivers. Outline 31 or 34, **OUTLINES SECTION**. Tube requires four-contact socket. Filament volts (dc), 2.0; amperes, 0.13. Typical operation as class A<sub>1</sub> amplifier: plate volts, 180 *max*; grid volts, -30; plate ma., 12.3; plate resistance, 3600 ohms; amplification factor, 3.8; transconductance, 1050 μmhos; load resistance, 5700 ohms; output watts, 0.375. This is a **DISCONTINUED** type listed for reference only.

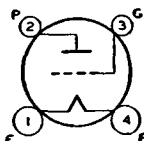
**SHARP-CUTOFF TETRODE**
**32**

Glass type used as rf amplifier or biased detector in battery-operated receivers. Outline 41, **OUTLINES SECTION**. Tube requires four-contact socket. Filament volts (dc), 2.0; amperes, 0.06. Typical operation as class A<sub>1</sub> amplifier: plate volts, 180 *max*; grid-No.2 ma., 0.4 *max*; plate resistance, greater than 1 megohm; plate ma., 1.7; transconductance, 650 μmhos. This is a **DISCONTINUED** type listed for reference only.

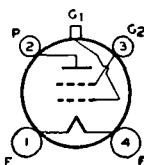
**RECTIFIER—BEAM POWER TUBE**
**32L7-GT**

Glass octal type used as combined half-wave rectifier and output amplifier in ac/dc receivers. Outline 23, **OUTLINES SECTION**. Tube requires octal socket. Heater volts (ac/dc), 32.5; amperes, 0.3. Maximum ratings for rectifier unit: ac plate volts (rms), 125; dc output ma., 60. Typical operation of beam power unit as class A<sub>1</sub> amplifier: plate and grid-No.2 volts,

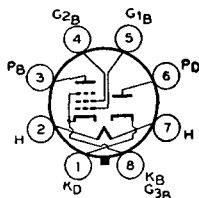

90; grid-No.1 volts, -7; plate ma., 27; grid-No.2 ma., 2; plate resistance, 17000 ohms; transconductance, 4800 μmhos; load resistance, 2600 ohms; maximum-signal output watts, 1.0. This is a **DISCONTINUED** type listed for reference only.

**POWER PENTODE**
**33**

Glass type used in output stage of battery-operated receivers. Outline 38, **OUTLINES SECTION**. Tube requires five-contact socket. Filament volts (dc), 2.0; amperes, 0.26. Typical operation as class A<sub>1</sub> amplifier: plate and grid-No.2 volts, 180 *max*; grid-No.1 volts, -18; plate ma., 22; grid-No.2 ma., 5; plate resistance, 55000 ohms; transconductance, 1750 μmhos;

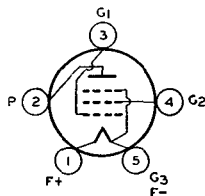

load resistance, 6000 ohms; output watts, 1.4. This is a **DISCONTINUED** type listed for reference only.

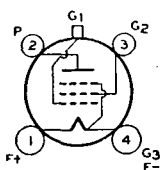

**REMOTE-CUTOFF PENTODE**

Glass type used as rf or if amplifier in battery-operated radio receivers, particularly those employing avc. Outline 41, OUTLINES SECTION. Tube requires four-contact socket. Filament volts (dc), 2.0; amperes, 0.06. Characteristics as class A<sub>1</sub> amplifier: plate volts, 180 max; grid-No.2 volts, 67.5 max; grid-No.1 volts, -3 min; plate ma., 2.8; grid-No.2 ma., 1.0; plate

**34**

resistance, 1.0 megohm; transconductance, 620 μmhos; transconductance at grid-No.1 bias of -22.5 volts, 15 μmhos. This is a DISCONTINUED type listed for reference only.

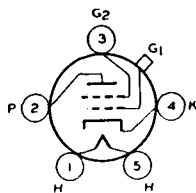

**REMOTE-CUTOFF TETRODE**

Glass type used as rf or if amplifier in ac receivers. Outline 41, OUTLINES SECTION. Tube requires five-contact socket. Heater volts (ac/dc), 2.5; amperes, 1.75. Characteristics as class A<sub>1</sub> amplifier: plate volts, 250 (275 max); grid-No.2 volts, 90 max; grid-No.1 volts, -3 min; plate ma., 6.5; grid-No.2 ma., 2.5; transconductance, 1050 μmhos; transconductance at grid-No.1 bias of -40 volts, 15 μmhos. This is a DISCONTINUED type listed for reference only.

**35**

grid-No.1 bias of -40 volts, 15 μmhos. This is a DISCONTINUED type listed for reference only.

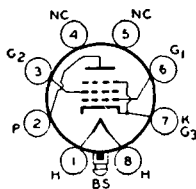

**BEAM POWER TUBE**

Glass lock-in type used in output stage of ac/dc receivers. Outline 20, OUTLINES SECTION. Tube requires lock-in socket. Heater volts (ac/dc), 35; amperes, 0.15. For ratings, and curves, refer to glass-octal type 35L6-GT. Type 35A5 is used principally for renewal purposes.

**35A5**

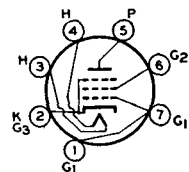

**BEAM POWER TUBE**

Miniature type used in output stage of compact, ac/dcradio receivers. Because of its high power sensitivity at plate and screen voltages available in ac/dc receivers, it is capable of providing a relatively high power output. Outline 16, OUTLINES SECTION. Tube requires miniature seven-contact socket and may be mounted in any position. Within its maximum ratings, type 35B5 is equivalent in performance to glass-octal type 35L6-GT, and miniature type 35C5. Refer to type 35C5 for typical operation, maximum circuit values, installation, application information, and curves.

**35B5**

providing a relatively high power output. Outline 16, OUTLINES SECTION. Tube requires miniature seven-contact socket and may be mounted in any position. Within its maximum ratings, type 35B5 is equivalent in performance to glass-octal type 35L6-GT, and miniature type 35C5. Refer to type 35C5 for typical operation, maximum circuit values, installation, application information, and curves.

|   |      |        |
|---|------|--------|
| HEATER VOLTS (AC/DC).....                                   | 35   | volts  |
| HEATER CURRENT.....   | 0.15 | ampere |
| DIRECT INTERELECTRODE CAPACITANCES (Approx.):               |      |        |
| Grid No.1 to Plate.....                                     | 0.4  | μμf    |
| Grid No.1 to Cathode, Heater, Grid No.2, and Grid No.3..... | 11   | μμf    |
| Plate to Cathode, Heater, Grid No.2, and Grid No.3.....     | 6.5  | μμf    |

|  |         |       |
|--|---------|-------|
| <b>Maximum Ratings:</b>                      |         |       |
| PLATE VOLTAGE.....                           | 117 max | volts |
| GRID-NO.2 (SCREEN) VOLTAGE.....              | 117 max | volts |
| PLATE DISSIPATION.....                       | 4.5 max | watts |
| GRID-NO.2 INPUT.....                         | 1.0 max | watt  |
| <b>PEAK HEATER-CATHODE VOLTAGE:</b>          |         |       |
| Heater negative with respect to cathode..... | 150 max | volts |
| Heater positive with respect to cathode..... | 150 max | volts |

**BEAM POWER TUBE**

**35C5**

Miniature type used in output stage of compact, ac/dc radio receivers. Because of its high power sensitivity and high efficiency at plate and screen voltages available in ac/dc receivers, the 35C5 is capable of providing a relatively high power output. Except

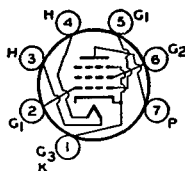

for terminal connections and slightly higher ratings, type 35C5 is equivalent in performance to miniature type 35B5 and, within its maximum ratings, to glass-octal type 35L6-GT. The basing arrangement of the 35C5 simplifies the problem of meeting Underwriters' Laboratories requirements in the design of ac/dc receivers.

|                              |      |        |
|------------------------------|------|--------|
| HEATER VOLTAGE (AC/DC) ..... | 35   | volts  |
| HEATER CURRENT .....         | 0.15 | ampere |

**DIRECT INTERELECTRODE CAPACITANCES (Approx.):**

|  |      |                  |
|--|------|------------------|
| Grid No.1 to Plate .....                                     | 0.60 | $\mu\mu\text{f}$ |
| Grid No.1 to Cathode, Heater, Grid No.2, and Grid No.3 ..... | 12   | $\mu\mu\text{f}$ |
| Plate to Cathode, Heater, Grid No.2, and Grid No.3 .....     | 9.0  | $\mu\mu\text{f}$ |

**Maximum Ratings: CLASS A<sub>1</sub> AMPLIFIER**

|   |                |       |
|---|----------------|-------|
| PLATE VOLTAGE .....                                       | 135 <i>maz</i> | volts |
| GRID-NO.2 (SCREEN) VOLTAGE .....                          | 117 <i>maz</i> | volts |
| PLATE DISSIPATION .....                                   | 4.5 <i>maz</i> | watts |
| GRID-NO.2 INPUT .....                                     | 1.0 <i>maz</i> | watt  |
| <b>PEAK HEATER-CATHODE VOLTAGE:</b>                       |                |       |
| Heater negative with respect to cathode .....             | 180 <i>maz</i> | volts |
| Heater positive with respect to cathode .....             | 180 <i>maz</i> | volts |
| BULB TEMPERATURE (At hottest point on bulb surface) ..... | 250 <i>maz</i> | °C    |

**Typical Operation:**

|  |       |                  |
|--|-------|------------------|
| Plate Voltage .....                              | 110   | volts            |
| Grid-No.2 Voltage .....                          | 110   | volts            |
| Peak AF Grid-No.1 Voltage .....                  | 7.5   | volts            |
| Zero-Signal Plate Current .....                  | 40    | ma               |
| Maximum-Signal Plate Current .....               | 41    | ma               |
| Zero-Signal Grid-No.2 Current (Approx.) .....    | 3     | ma               |
| Maximum-Signal Grid-No.2 Current (Approx.) ..... | 7     | ma               |
| Plate Resistance (Approx.) .....                 | 13000 | ohms             |
| Transconductance .....                           | 5800  | $\mu\text{mhos}$ |
| Load Resistance .....                            | 2500  | ohms             |
| Total Harmonic Distortion .....                  | 10    | per cent         |
| Maximum-Signal Power Output .....                | 1.5   | watts            |

**Maximum Circuit Values (For maximum rated conditions):**

|                                      |                |        |
|--------------------------------------|----------------|--------|
| <b>Grid-No.1-Circuit Resistance:</b> |                |        |
| For fixed-bias operation .....       | 0.1 <i>maz</i> | megohm |
| For cathode-bias operation .....     | 0.5 <i>maz</i> | megohm |

**INSTALLATION AND APPLICATION**

Type 35C5 requires miniature seven-contact socket and may be mounted in any position. Outline 16, OUTLINES SECTION. It is especially important that this tube, like other power-handling tubes, should be adequately ventilated.

The 35-volt heater is designed to operate under the normal conditions of line-voltage variation without materially affecting the performance or serviceability of the 35C5. For operation of the 35C5 in series with other types having 0.15-ampere rating, the current in the heater circuit should be adjusted to 0.15 ampere for the normal supply voltage.

In a series-heater circuit of the "dc power line" type employing several 0.15-ampere types and one or two 35C5's, the heater(s) of the 35C5('s) should be placed on the positive side of the line. Under these conditions, heater-cathode voltage of the 35C5 must not exceed the value given under maximum ratings. In a series-heater circuit of the "universal" type employing rectifier tube 35W4, one or two 35C5's and several 0.15-ampere types, it is recommended that the heater(s) of the 35C5('s), be placed in the circuit so that the higher values of heater-cathode bias will be impressed on the 35C5('s) rather than on the other 0.15-ampere types. This is accomplished by arranging the 35C5('s) on the side of the supply line which is connected to the cathode of the rectifier, i.e., the positive terminal of the rectified voltage supply. Between this side of the line and the 35C5('s), any necessary auxiliary resistance and the heater of the 35W4 are connected in series.

As a power amplifier (class A<sub>1</sub>), the 35C5 is recommended for use either singly or in push-pull combination in the power-output stage of "ac/dc" receivers. The operating values shown under typical operation have been determined on the basis that grid-No.1 current does not flow during any part of the input cycle.

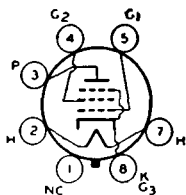
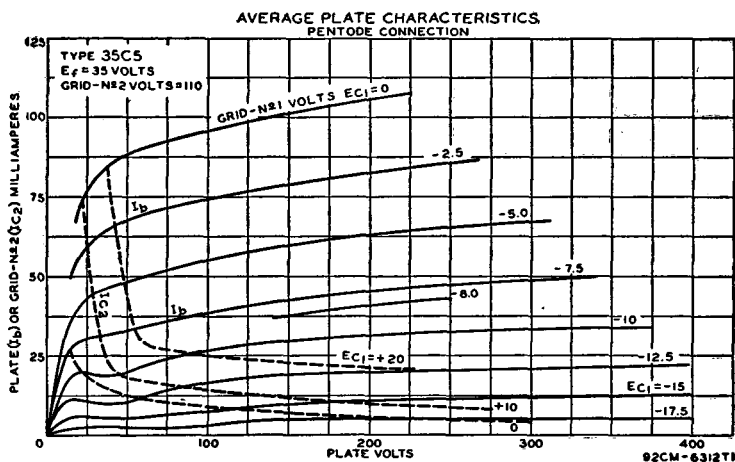

### BEAM POWER TUBE

Glass octal type used in output stage of ac/dc radio receivers. Outline 23, OUTLINES SECTION. Tube requires octal socket and may be mounted in any position. This type

## 35L6-GT

may be supplied with pin No.1 omitted. Refer to miniature type 35C5 for installation, application information, and curves.

|  |      |        |
|--|------|--------|
| HEATER VOLTAGE (AC/DC) .....                                 | 35   | volts  |
| HEATER CURRENT .....   | 0.15 | ampere |
| DIRECT INTERELECTRODE CAPACITANCES (Approx.):                |      |        |
| Grid No.1 to Plate .....                                     | 0.6  | μf     |
| Grid No.1 to Cathode, Heater, Grid No.2, and Grid No.3 ..... | 13   | μf     |
| Plate to Cathode, Heater, Grid No.2, and Grid No.3 .....     | 9.5  | μf     |

## CLASS A<sub>1</sub> AMPLIFIER

### Maximum Ratings:

|  |                |       |
|--|----------------|-------|
| PLATE VOLTAGE.....                           | 200 <i>max</i> | volts |
| GRID-NO.2 (SCREEN) VOLTAGE.....              | 117 <i>max</i> | volts |
| PLATE DISSIPATION.....                       | 8.5 <i>max</i> | watts |
| GRID-NO.2 INPUT.....                         | 1.0 <i>max</i> | watt  |
| <b>PEAK HEATER-CATHODE VOLTAGE:</b>          |                |       |
| Heater negative with respect to cathode..... | 150 <i>max</i> | volts |
| Heater positive with respect to cathode..... | 150 <i>max</i> | volts |

### Typical Operation:

|   | <i>Fixed Bias</i> | <i>Cathode Bias</i> |          |
|---|-------------------|---------------------|----------|
| Plate Voltage.....                              | 110               | 200                 | volts    |
| Grid-No.2 Voltage.....                          | 110               | 110                 | volts    |
| Grid-No.1 (Control-Grid) Voltage.....           | -7.5              | -                   | volts    |
| Cathode Resistor.....                           | -                 | 180                 | ohms     |
| Peak AF Grid-No.1 Voltage.....                  | 7.5               | 8                   | volts    |
| Zero-Signal Plate Current.....                  | 40                | 43                  | ma       |
| Maximum-Signal Plate Current.....               | 41                | 43                  | ma       |
| Zero-Signal Grid-No.2 Current (Approx.).....    | 3                 | 2                   | ma       |
| Maximum-Signal Grid-No.2 Current (Approx.)..... | 7                 | 5.5                 | ma       |
| Plate Resistance (Approx.).....                 | 14000             | 34000               | ohms     |
| Transconductance.....                           | 5800              | 6100                | μmhos    |
| Load Resistance.....                            | 2500              | 5000                | ohms     |
| Total Harmonic Distortion.....                  | 10                | 10                  | per cent |
| Maximum-Signal Power Output.....                | 1.5               | 3.0                 | watts    |

## HALF-WAVE VACUUM RECTIFIER

# 35W4

Miniature type used in power supply of ac/dc receivers. Equivalent in performance to glass-octal type 35Z5-GT. The heater is provided with a tap for operation of a panel lamp.

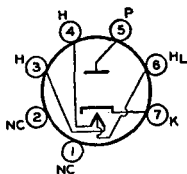

|  |      |      |        |
|--|------|------|--------|
| <b>HEATER VOLTAGE (AC/DC):</b>         | *    | **   |        |
| ENTIRE HEATER (PINS 3 AND 4).....      | 35   | 32   | volts  |
| PANEL LAMP SECTION (PINS 4 AND 6)..... | 7.5  | 5.5  | volts  |
| <b>HEATER CURRENT:</b>                 |      |      |        |
| BETWEEN PINS 3 AND 4.....              | 0.15 | -    | ampere |
| BETWEEN PINS 3 AND 6.....              | -    | 0.15 | ampere |

\* Without panel lamp.

\*\* With No.40 or No.47 panel lamp.

### Maximum Ratings:

### HALF-WAVE RECTIFIER

|   |                |       |
|---|----------------|-------|
| PEAK INVERSE PLATE VOLTAGE.....                 | 330 <i>max</i> | volts |
| PEAK PLATE CURRENT.....                         | 600 <i>max</i> | ma    |
| <b>DC OUTPUT CURRENT:</b>                       |                |       |
| With Panel Lamp and { No Shunting Resistor..... | 60 <i>max</i>  | ma    |
| { Shunting Resistor.....                        | 90 <i>max</i>  | ma    |
| Without Panel Lamp.....                         | 100 <i>max</i> | ma    |
| <b>PANEL-LAMP-SECTION VOLTAGE (rms):</b>        |                |       |
| When Panel Lamp Fails.....                      | 15 <i>max</i>  | volts |
| <b>PEAK HEATER-CATHODE VOLTAGE:</b>             |                |       |
| Heater negative with respect to cathode.....    | 330 <i>max</i> | volts |
| Heater positive with respect to cathode.....    | 330 <i>max</i> | volts |

### Typical Operation with Panel Lamp:†

|  |     |     |     |     |       |
|--|-----|-----|-----|-----|-------|
| AC Plate-Supply Voltage (rms).....                         | 117 | 117 | 117 | 117 | volts |
| Filter-Input Capacitor.....                                | 40  | 40  | 40  | 40  | μf    |
| <b>Minimum Total Effective Plate-Supply Impedance.....</b> |     |     |     |     |       |
|  | 15  | 15  | 15  | 15  | ohms  |
| Panel-Lamp Shunting Resistor.....                          | -   | 300 | 150 | 100 | ohms  |
| DC Output Current.....                                     | 60  | 70  | 80  | 90  | ma    |

† No.40 or No.47 panel lamp used in circuit given below with capacitor-input filter.

## Typical Operation without Panel Lamp:

|  |     |         |
|--|-----|---------|
| AC Plate-Supply Voltage (rms) .....                  | 117 | volts   |
| Filter-Input Capacitor .....                         | 40  | $\mu$ f |
| Minimum Total Effective Plate-Supply Impedance ..... | 15  | ohms    |
| DC Output Current .....                              | 100 | ma      |
| DC Output Voltage at Input to Filter (Approx.):      |     |         |
| At half-load current (50 ma.) .....                  | 135 | volts   |
| At full-load current (100 ma.) .....                 | 120 | volts   |
| Voltage Regulation (Approx.):                        |     |         |
| Half-load to full-load current .....                 | 15  | volts   |

## Maximum Circuit Values:

### Panel-Lamp Shunting Resistor\*:

|  |         |      |
|--|---------|------|
| For dc output current of $\left\{ \begin{array}{l} 70 \text{ ma.} \\ 80 \text{ ma.} \\ 90 \text{ ma.} \end{array} \right.$ ..... | 800 max | ohms |
|  | 400 max | ohms |
|  | 250 max | ohms |

\*Required when dc output current is greater than 60 milliamperes.

## INSTALLATION AND APPLICATION

Tube requires miniature seven-contact socket and may be mounted in any position. Outline 16, OUTLINES SECTION. For heater considerations, refer to miniature type 35C5.

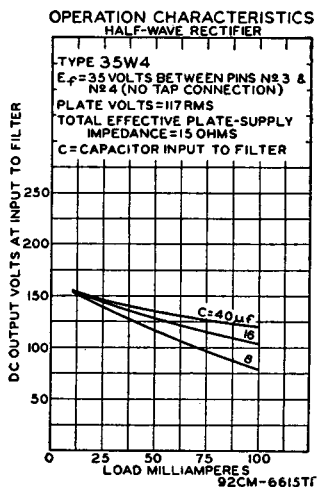

With the panel lamp connected as shown in the diagram, the drop across R and all heaters (with panel lamp) should equal 117 volts at 0.15 ampere. The shunting resistor  $R_s$  is required when dc output current exceeds 60 milliamperes. Values of  $R_s$  for dc output currents greater than 60 milliamperes are given in tabulated data.

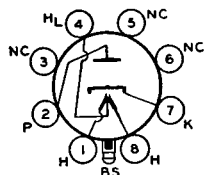
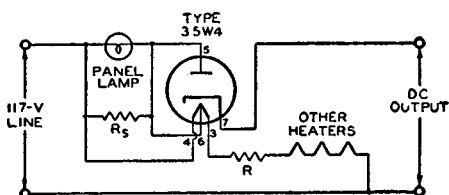

## HALF-WAVE VACUUM RECTIFIER

Glass lock-in type used in power supply of ac/dc receivers. The heater is provided with tap for the operation of a panel lamp. Outline 20, OUTLINES SECTION. Tube requires lock-in socket. Heater volts (ac/dc), 35; amperes, 0.15. For maximum ratings, refer to glass-octal type 35Z5-GT. For typical operation and curves, refer to miniature type 35W4. Type 35Y4 is used principally for renewal purposes.

# 35Y4

# 35Z3

## HALF-WAVE VACUUM RECTIFIER

Glass lock-in type used in power supply of ac/dc receivers. Outline 20, OUTLINES SECTION. Tube requires lock-in socket. Heater volts (ac/dc), 35; amperes, 0.15. For maximum ratings and typical operation, refer to glass-octal type 35Z5-GT without panel lamp. Type 35Z3 is used principally for renewal purposes.

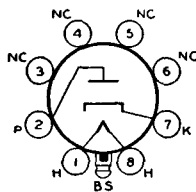

# 35Z4-GT

## HALF-WAVE VACUUM RECTIFIER

Glass octal type used in power supply of ac/dc receivers. Outline 23, OUTLINES SECTION. Tube requires octal socket. This type may be supplied with pin No.1 omitted. Heater volts (ac/dc), 35; amperes, 0.15. For maximum ratings and typical operation, refer to glass-octal type 35Z5-GT without panel lamp. Type 35Z4-GT is used principally for renewal purposes.

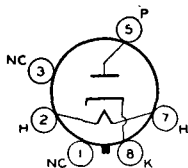

# 35Z5-GT

## HALF-WAVE VACUUM RECTIFIER

Glass octal type used in power supply of ac/dc receivers. The heater is provided with a tap for operation of a panel lamp. Outline 23, OUTLINES SECTION. Tube requires

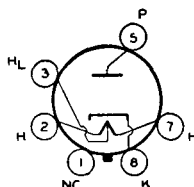

octal socket and may be mounted in any position. This type may be supplied with pin No.1 omitted. For installation and application considerations, refer to miniature type 35W4.

|   |      |      |        |
|---|------|------|--------|
| <b>HEATER VOLTAGE (AC/DC):</b>          | *    | **   |        |
| ENTIRE HEATER (PINS 2 AND 7) .....      | 35   | 32   | volts  |
| PANEL LAMP SECTION (PINS 2 AND 3) ..... | 7.5  | 5.5  | volts  |
| <b>HEATER CURRENT:</b>                  |      |      |        |
| BETWEEN PINS 2 AND 7 .....              | 0.15 | -    | ampere |
| BETWEEN PINS 3 AND 7 .....              | -    | 0.15 | ampere |

\* Without panel lamp.

\*\* With No.40 or No. 47 panel lamp.

### Maximum Ratings:

### HALF-WAVE RECTIFIER

|  |  |         |       |
|--|--|---------|-------|
| PEAK INVERSE PLATE VOLTAGE .....                 |  | 700 max | volts |
| PEAK PLATE CURRENT .....                         |  | 600 max | ma    |
| DC OUTPUT CURRENT:                               |  |         |       |
| With Panel Lamp and { No Shunting Resistor ..... |  | 60 max  | ma    |
| { Shunting Resistor .....                        |  | 90 max  | ma    |
| Without Panel Lamp .....                         |  | 100 max | ma    |
| PANEL-LAMP-SECTION VOLTAGE (rms):                |  |         |       |
| When Panel Lamp Fails .....                      |  | 15 max  | volts |
| PEAK HEATER-CATHODE VOLTAGE:                     |  |         |       |
| Heater negative with respect to cathode .....    |  | 350 max | volts |
| Heater positive with respect to cathode .....    |  | 350 max | volts |

### Typical Operation with Panel Lamp:†

|  |     |     |     |     |     |       |
|--|-----|-----|-----|-----|-----|-------|
| AC Plate-Supply Voltage (rms) .....                  | 117 | 117 | 117 | 117 | 235 | volts |
| Filter-Input Capacitor .....                         | 40  | 40  | 40  | 40  | 40  | μf    |
| Minimum Total Effective Plate-Supply Impedance ..... | 15  | 15  | 15  | 15  | 100 | ohms  |
| Panel-Lamp Shunting Resistor .....                   | -   | 300 | 150 | 100 | -   | ohms  |
| DC Output Current .....                              | 60  | 70  | 80  | 90  | 60  | ma    |

† No.40 or No.47 panel lamp used in circuit with capacitor-input filter given under type 35W4.

### Typical Operation without Panel Lamp:

|  |     |     |       |
|--|-----|-----|-------|
| AC Plate-Supply Voltage (rms) .....                  | 117 | 235 | volts |
| Filter-Input Capacitor .....                         | 40  | 40  | μf    |
| Minimum Total Effective Plate-Supply Impedance ..... | 15  | 100 | ohms  |
| DC Output Current .....                              | 100 | 100 | ma    |
| DC Output Voltage at Input to Filter (Approx.):      |     |     |       |
| At half-load current (50 ma.) .....                  | 140 | 280 | volts |
| At full-load current (100 ma.) .....                 | 120 | 235 | volts |
| Voltage Regulation (Approx.):                        |     |     |       |
| Half-load to full-load current .....                 | 20  | 45  | volts |



**Maximum Circuit Values:**

**Panel-Lamp Shunting Resistor\*:**

|                          |               |                |      |
|--------------------------|---------------|----------------|------|
| For dc output current of | { 70 ma ..... | 800 <i>max</i> | ohms |
|                          | { 80 ma ..... | 400 <i>max</i> | ohms |
|                          | { 90 ma ..... | 250 <i>max</i> | ohms |

\* Required when dc output current is greater than 60 milliamperes.

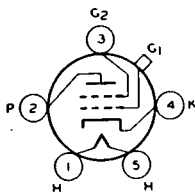

**SHARP-CUTOFF TETRODE**

Glass type used as rf or if amplifier or as biased or grid-resistor detector in radio receivers. Outline 36, OUTLINES SECTION. Tube requires five-contact socket. Heater volts (ac/dc), 6.3; amperes, 0.3. Characteristics as class A<sub>1</sub> amplifier: plate volts, 250 *max*; grid-No.2 volts, 90 *max*; grid-No.1 volts, -3; plate ma., 3.2; grid-No.2 ma., 1.7 *max*; plate resistance, 0.55 megohm; transconductance, 1080  $\mu$ mhos. This is a DISCONTINUED type listed for reference only.

**36**

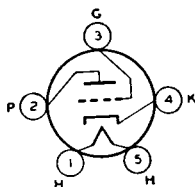

**MEDIUM-MU TRIODE**

Glass type used as voltage amplifier or detector in radio receivers. Outline 31 or 34, OUTLINES SECTION. Tube requires five-contact socket. Heater volts (ac/dc), 6.3; amperes, 0.3. Characteristics as class A<sub>1</sub> amplifier: plate volts, 250 *max*; grid volts, -18; plate ma., 7.5; plate resistance, 8400 ohms; amplification factor, 9.2; transconductance, 1100  $\mu$ mhos. This is a DISCONTINUED type listed for reference only.

**37**

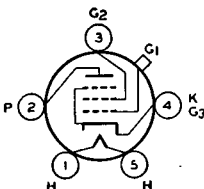

**POWER PENTODE**

Glass type used in output stage of radio receivers. Outline 36, OUTLINES SECTION. Tube requires five-contact socket. Heater volts (ac/dc), 6.3; amperes, 0.3. Characteristics as class A<sub>1</sub> amplifier: plate and grid-No.2 volts, 250 *max*; grid-No.1 volts, -25; plate ma., 22; grid-No.2 ma., 3.8; plate resistance, 0.1 megohm; transconductance, 1200  $\mu$ mhos; load resistance, 10000 ohms; output watts, 2.5. This is a DISCONTINUED type listed for reference only.

**38**

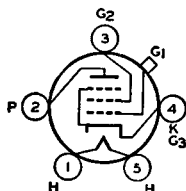

**REMOTE-CUTOFF PENTODE**

Glass type used as rf or if amplifier in radio receivers, particularly those employing ave. Outline 36, OUTLINES SECTION. Tube requires five-contact socket. Heater volts (ac/dc), 6.3; amperes, 0.3. Characteristics as class A<sub>1</sub> amplifier: plate volts, 250 *max*; grid-No.2 volts, 90 *max*; grid-No.1 volts, -3 *min*; plate ma., 5.8; grid-No.2 ma., 1.4; plate resistance, 1.0 megohm; transconductance, 1050  $\mu$ mhos; transconductance at grid-No.1 bias of -42.5 volts, 2  $\mu$ mhos. This is a DISCONTINUED type listed for reference only.

**39/44**

ohm; transconductance, 1050  $\mu$ mhos; transconductance at grid-No.1 bias of -42.5 volts, 2  $\mu$ mhos. This is a DISCONTINUED type listed for reference only.

**MEDIUM-MU TRIODE**

Glass type used as resistance-coupled or impedance-coupled amplifier in battery-operated receivers. Outline 38, OUTLINES SECTION. Filament volts (dc), 5; amperes, 0.25. Characteristics as class A<sub>1</sub> amplifier: plate-supply volts, 180; load resistance, 250000 ohms; grid volts, -3; plate ma., 0.2; plate resistance, 150000 ohms; amplification factor, 30; transconductance, 200  $\mu$ mhos. This is a DISCONTINUED type listed for reference only.

**40**

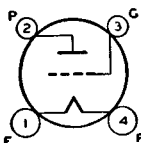

**41**

**POWER PENTODE**

Glass type used in output stage of radio receivers. Outline 31 or 34, **OUTLINES SECTION**. Tube requires six-contact socket. Heater volts (ac/dc), 6.3; amperes, 0.4. This type is electrically identical with type 6K6-GT. Type 41 is used principally for renewal purposes.

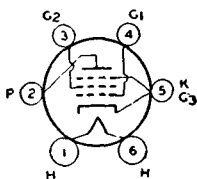

**42**

**POWER PENTODE**

Glass type used in audio output stage of ac receivers. Outline 38, **OUTLINES SECTION**. Tube requires six-contact socket. Heater volts (ac/dc), 6.3; amperes, 0.7. This type is electrically identical with type 6F6. Type 42 is used principally for renewal purposes.

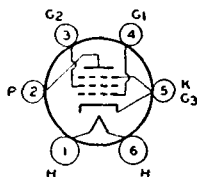

**43**

**POWER PENTODE**

Glass type used in audio output stage of ac/dc receivers. Outline 38, **OUTLINES SECTION**. Tube requires six-contact socket. Heater volts (ac/dc), 25; amperes, 0.3. This type is electrically identical with type 25A6. Type 43 is used principally for renewal purposes.

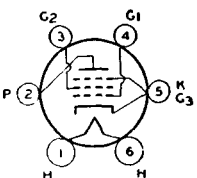

**45**

**POWER TRIODE**

Glass type used in output stage of radio receivers. Outline 38, **OUTLINES SECTION**. Tube requires four-contact socket and should preferably be mounted in vertical position. Horizontal operation is permissible if pins 1 and 4 are in vertical plane. This type is used principally for renewal purposes.

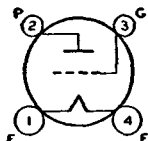

|                                |     |         |
|--------------------------------|-----|---------|
| FILAMENT VOLTAGE (AC/DC) ..... | 2.5 | volts   |
| FILAMENT CURRENT .....         | 1.5 | amperes |

**CLASS A<sub>1</sub> AMPLIFIER**

**Typical Operation:**

|                                     |       |      |      |       |
|-------------------------------------|-------|------|------|-------|
| Plate Voltage (275 volts max) ..... | 180   | 250  | 275  | volts |
| Grid Voltage* .....                 | -31.5 | -50  | -56  | volts |
| Cathode-Bias Resistor .....         | 1020  | 1470 | 1550 | ohms  |
| Plate Current .....                 | 31    | 34   | 36   | ma    |
| Plate Resistance .....              | 1650  | 1610 | 1700 | ohms  |
| Amplification Factor .....          | 3.5   | 3.5  | 3.5  |       |
| Transconductance .....              | 2125  | 2175 | 2050 | μmhos |
| Load Resistance .....               | 2700  | 3900 | 4600 | ohms  |
| Undistorted Power Output .....      | 0.825 | 1.6  | 2.0  | watts |

\* Grid volts measured from mid-point of ac-operated filament. Cathode bias is advisable in all cases required if grid-coupling resistor (max value of 1.0 megohm) is used.

**HALF-WAVE VACUUM RECTIFIER**

**45Z3**

Miniature type used in power supply of small, portable, ac/dc/battery receivers where small size and low heat dissipation are important. Outline 13, **OUTLINES SECTION**. Tube requires miniature seven-contact socket and may be mounted in any position. Heater volts (ac/dc) 45; amperes, 0.075. Maximum ratings: peak inverse plate volts, 350 max; peak plate

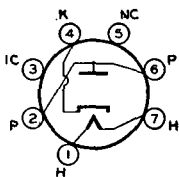

ma., 390 max; dc output ma., 65 max; peak heater-cathode volts, 175 max. Typical operation with capacitor-input filter: ac plate volts (rms), 117; minimum total effective plate-supply impedance, 15 ohms; dc output ma., 65. This is a **DISCONTINUED** type listed for reference only.

### HALF-WAVE VACUUM RECTIFIER

Glass octal type used in power supply of ac/dc receivers. The heater is provided with a tap for operation of a panel lamp. Outline 23, OUTLINES SECTION. Tube requires octal socket. This type may be supplied with pin No.1 omitted. Except for difference in heater voltage, this type has the same ratings and typical operation values as glass-octal type

**45Z5-GT**

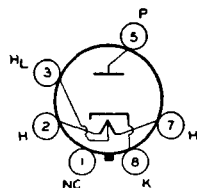

35Z5-GT. Type 45Z5-GT is a DISCONTINUED type listed for reference only.

|   |      |      |        |
|---|------|------|--------|
| HEATER VOLTAGE (AC/DC):                 | *    | **   |        |
| ENTIRE HEATER (PINS 2 AND 7).....       | 45   | 42   | volts  |
| PANEL LAMP SECTIONS (PINS 2 AND 3)..... | 7.5  | 5.5  | volts  |
| HEATER CURRENT:                         |      |      |        |
| BETWEEN PINS 2 AND 7.....               | 0.15 | -    | ampere |
| BETWEEN PINS 3 AND 7.....               | -    | 0.15 | ampere |

\* Without panel lamp. \*\* With No. 40 or No.47 panel lamp.

### DUAL-GRID POWER AMPLIFIER

Glass type used as class A<sub>1</sub> or class B amplifier in radio equipment. Outline 43, OUTLINES SECTION. Tube requires five-contact socket. Filament volts (ac/dc), 2.5; amperes, 1.75. Typical operation as class A<sub>1</sub> amplifier (grid No.2 connected to plate at socket): plate volts, 250 max; grid volts, -33; plate ma., 22; plate resistance, 2380 ohms; am-

**46**

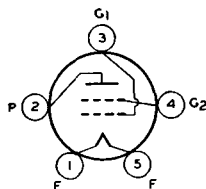

plification factor, 5.6; transconductance, 2350  $\mu$ mhos; load resistance for maximum undistorted power output, 6400 ohms; undistorted output watts, 1.25. This is a DISCONTINUED type listed for reference only.

### POWER PENTODE

Glass type used in audio output stage of radio receivers. Outline 43, OUTLINES SECTION. Tube requires five-contact socket and should preferably be mounted in vertical position. Horizontal operation is permissible if pins 1 and 5 are in vertical plane. Filament volts (ac/dc), 2.5; amperes, 1.75. Typical operation as class A<sub>1</sub> amplifier: plate and grid-No.2 volts,

**47**

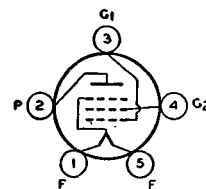

250 max; cathode-bias resistor, 450 ohms; plate ma., 31; grid-No.2 ma., 6; plate resistance, 60000 ohms; transconductance, 2500  $\mu$ mhos; load resistance, 7000 ohms; power output, 2.7 watts. This type is used principally for renewal purposes.

### POWER TETRODE

Glass type used in audio output stage of radio receivers designed to operate from dc power lines. Outline 43, OUTLINES SECTION Heater volts (dc), 30; amperes, 0.4. Typical operation as class A<sub>1</sub> amplifier: plate volts, 125 max; grid-No.2 volts, 100 max; grid-No.1 volts, -20; plate ma., 56; grid-No.2 ma., 9.5; transconductance, 3900  $\mu$ mhos; load resistance, 1500 ohms; output watts, 2.5. This is a DISCONTINUED type listed for reference only.

**48**

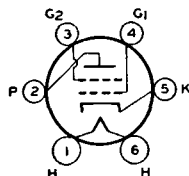

### DUAL-GRID POWER AMPLIFIER

Glass type used in output stage of battery-operated receivers. Outline 38, OUTLINES SECTION. Tube requires five-contact socket. Filament volts (dc), 2.0; amperes, 0.12. Typical operation as class A<sub>1</sub> amplifier (grid No.2 connected to plate at socket): plate volts, 135 max; grid volts, -20; plate ma., 6; plate resistance, 4175 ohms; amplification factor, 4.7; transconductance, 1125  $\mu$ mhos; load resistance, 11000 ohms; output watts (approx.), 0.17. This is a DISCONTINUED type listed for reference only.

**49**

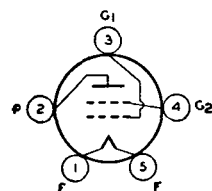

**POWER TRIODE**

**50**

Glass type used in output stage of *af* amplifiers employing transformer input coupling. Outline 45, OUTLINES SECTION. Tube requires four-contact socket and should be mounted in vertical position with base down. Filament volts (ac/dc), 7.5; amperes, 1.25. Characteristics as class A<sub>1</sub> amplifier: plate volts, 450 max; grid volts, -84; cathode resistor, 1580 ohms; plate

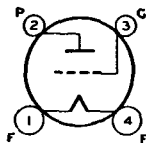

ma., 55; plate resistance, 1800 ohms; amplification factor, 3.8; transconductance, 2100  $\mu$ mhos; load resistance, 4350 ohms; output watts, 4.6. Resistance in grid-coupling circuit should not exceed 10000 ohms. This is a DISCONTINUED type listed for reference only.

**BEAM POWER TUBE**

**50A5**

Glass lock-in type used in output stage of ac/dc receivers. Outline 20, OUTLINES SECTION. Tube requires lock-in socket. Heater volts (ac/dc), 50; amperes, 0.15. For ratings and data, refer to glass-octal type 50L6-GT. Type 50A5 is used principally for renewal purposes.

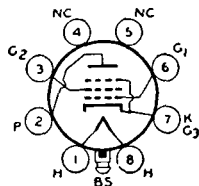

**BEAM POWER TUBE**

**50B5**

Miniature type used in output stage of compact ac/dc receivers. Because of its high power sensitivity at plate and screen voltages available in ac/dc receivers, it is capable of providing

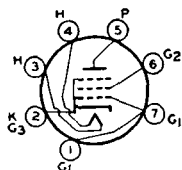

a relatively high power output. Outline 16, OUTLINES SECTION. Tube requires miniature seven-contact socket and may be mounted in any position. Within its maximum ratings, type 50B5 is equivalent in performance to glass-octal type 50L6-GT and miniature type 50C5. Refer to type 50C5 for maximum ratings, typical operation, maximum circuit values, installation, application information, and curves.

|  |      |         |
|--|------|---------|
| HEATER VOLTS (AC/DC).....                                    | 50   | volts   |
| HEATER CURRENT.....  | 0.15 | ampere  |
| DIRECT INTERELECTRODE CAPACITANCES (Approx.):                |      |         |
| Grid No.1 to Plate.....                                      | 0.5  | $\mu$ f |
| Grid No.1 to Cathode, Heater, Grid No.2, and Grid No. 3..... | 13   | $\mu$ f |
| Plate to Cathode, Heater, Grid No.2, and Grid No. 3.....     | 6.5  | $\mu$ f |

**BEAM POWER TUBE**

**50C5**

Miniature type used in output stage of compact, ac/dc radio receivers. Because of its high power sensitivity and high efficiency at plate and screen voltages available in ac/dc receivers, the 50C5 is capable of providing a relatively high power output. Except

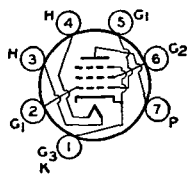

for terminal connections and slightly higher ratings, type 50C5 is equivalent in performance to miniature type 50B5 and, within its maximum ratings, to glass-octal type 50L6-GT. The basing arrangement of the 50C5 simplifies the problem of meeting Underwriters' Laboratories requirements in the design of ac/dc receivers.

|   |      |         |
|---|------|---------|
| HEATER VOLTAGE (AC/DC).....                                 | 50   | volts   |
| HEATER CURRENT.....   | 0.15 | ampere  |
| DIRECT INTERELECTRODE CAPACITANCES (Approx.):               |      |         |
| Grid No.1 to Plate.....                                     | 0.64 | $\mu$ f |
| Grid No.1 to Cathode, Heater, Grid No.2, and Grid No.3..... | 13   | $\mu$ f |
| Plate to Cathode, Heater, Grid No.2, and Grid No.3.....     | 6.1  | $\mu$ f |

## RCA Receiving Tube Manual

### CLASS A<sub>1</sub> AMPLIFIER

#### Maximum Ratings:

|  |          |       |
|--|----------|-------|
| PLATE VOLTAGE.....                                       | 135 max  | volts |
| GRID-NO.2 (SCREEN) VOLTAGE.....                          | 117 max  | volts |
| PLATE DISSIPATION.....                                   | 5.5 max  | watts |
| GRID-NO.2 INPUT.....                                     | 1.25 max | watts |
| PEAK HEATER-CATHODE VOLTAGE:                             |          |       |
| Heater negative with respect to cathode.....             | 180 max  | volts |
| Heater positive with respect to cathode.....             | 180 max  | volts |
| BULB TEMPERATURE (At hottest point on bulb surface)..... | 250 max  | °C    |

#### Typical Operation:

|   |       |          |
|---|-------|----------|
| Plate Voltage.....                              | 110   | volts    |
| Grid-No.2 Voltage.....                          | 110   | volts    |
| Grid-No.1 (Control-Grid) Voltage.....           | -7.5  | volts    |
| Peak AF Grid-No.1 Voltage.....                  | 7.5   | volts    |
| Zero-Signal Plate Current.....                  | 49    | ma       |
| Maximum-Signal Plate Current.....               | 50    | ma       |
| Zero-Signal Grid-No.2 Current (Approx.).....    | 4     | ma       |
| Maximum-Signal Grid-No.2 Current (Approx.)..... | 8.5   | ma       |
| Plate Resistance (Approx.).....                 | 10000 | ohms     |
| Transconductance.....                           | 7500  | μmhos    |
| Load Resistance.....                            | 2500  | ohms     |
| Total Harmonic Distortion.....                  | 9     | per cent |
| Maximum-Signal Power Output.....                | 1.9   | watts    |

#### Maximum Circuit Values (For maximum rated conditions):

|                                 |         |        |
|---------------------------------|---------|--------|
| Grid-No.1-Circuit Resistance:   |         |        |
| For fixed-bias operation.....   | 0.1 max | megohm |
| For cathode-bias operation..... | 0.5 max | megohm |

## INSTALLATION AND APPLICATION

Type 50C5 requires miniature seven-contact socket and may be mounted in any position. Outline 16, OUTLINES SECTION. It is especially important that this tube, like other power-handling tubes, be adequately ventilated.

The 50-volt heater is designed to operate under the normal conditions of line-voltage variation without materially affecting the performance or serviceability of the 50C5. For operation of the 50C5 in series with other types having 0.15-ampere rating, the current in the heater circuit should be adjusted to 0.15 ampere for the normal supply voltage.

In a series-heater circuit of the "dc power line" type employing several 0.15-ampere types and one or two 50C5's, the heater(s) of the 50C5(s) should be placed on the positive side of the line. Under these conditions, heater-cathode voltage of the 50C5 must not exceed the value given under maximum ratings. In a series-heater circuit of the "universal" type employing rectifier tube 35W4, one or two 50C5's, and several 0.15-ampere types, it is recommended that the heater(s) of the 50C5(s) be placed in the circuit so that the higher values of heater-cathode bias will be impressed on the 50C5(s) rather than on the other 0.15-ampere types. This is accomplished by arranging the 50C5(s) on the side of the supply line which is connected to the cathode of the rectifier, i.e., the positive terminal of the rectified voltage supply. Between this side of the line and the 50C5(s), any necessary auxiliary resistance and the heater of the 35W4 are connected in series.

As a power amplifier (class A<sub>1</sub>), the 50C5 is recommended for use either singly or in push-pull combination in the power-output stage of "ac/dc" receivers. The operating values shown under typical operation have been determined on the basis that grid-No.1 current does not flow during any part of the input cycle.

**AVERAGE PLATE CHARACTERISTICS  
PENTODE CONNECTION**

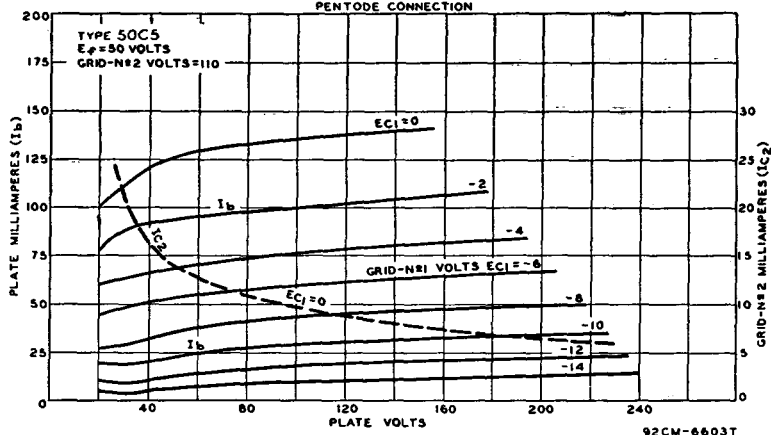

### BEAM POWER TUBE

## 50C6-G

Glass octal type used in output stage of ac/dc receivers. Outline 37, OUTLINES SECTION. Heater volts (ac/dc), 50; amperes, 0.15. Except for heater rating, this type is identical with glass octal type 6Y6-G. Type 50C6-G is used principally for renewal purposes.

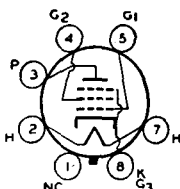

### BEAM POWER TUBE

## 50L6-GT

Glass octal type used in output stage of ac/dc radio receivers. Outline 23, OUTLINES SECTION. Tube requires octal socket and may be mounted in any position. This type may be supplied with pin No.1 omitted.

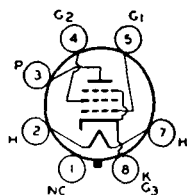

Refer to miniature type 50C5 for curves and installation and application information.

|   |      |        |
|---|------|--------|
| HEATER VOLTAGE (AC/DC).....                                 | 50   | volts  |
| HEATER CURRENT.....   | 0.15 | ampere |
| <b>DIRECT INTERELECTRODE CAPACITANCES (Approx.):</b>        |      |        |
| Grid No.1 to Plate.....                                     | 0.6  | μf     |
| Grid No.1 to Cathode, Heater, Grid No.2, and Grid No.3..... | 15   | μf     |
| Plate to Cathode, Heater, Grid No.2, and Grid No.3.....     | 9.5  | μf     |

### CLASS A<sub>1</sub> AMPLIFIER

**Maximum Ratings:**

|  |                 |       |
|--|-----------------|-------|
| PLATE VOLTAGE.....                           | 200 <i>max</i>  | volts |
| Grid-No.2 (SCREEN) VOLTAGE.....              | 125 <i>max</i>  | volts |
| PLATE DISSIPATION.....                       | 10 <i>max</i>   | watts |
| Grid-No.2 INPUT.....                         | 1.25 <i>max</i> | watts |
| <b>PEAK HEATER-CATHODE VOLTAGE:</b>          |                 |       |
| Heater negative with respect to cathode..... | 150 <i>max</i>  | volts |
| Heater positive with respect to cathode..... | 150 <i>max</i>  | volts |

**Typical Operation:**

|                                       | <i>Fixed Bias</i> | <i>Cathode Bias</i> |       |
|---------------------------------------|-------------------|---------------------|-------|
| Plate Voltage.....                    | 110               | 200                 | volts |
| Grid-No.2 Voltage.....                | 110               | 125                 | volts |
| Grid-No.1 (Control-Grid) Voltage..... | -7.5              | -                   | volts |
| Peak AF Grid-No.1 Voltage.....        | 7.5               | 8.0                 | volts |
| Cathode Resistor.....                 | -                 | 180                 | ohms  |

|  |       |       |            |
|--|-------|-------|------------|
| Zero-Signal Plate Current .....                  | 49    | 46    | ma         |
| Maximum-Signal Plate Current .....               | 50    | 47    | ma         |
| Zero-Signal Grid-No.2 Current (Approx.) .....    | 4     | 2.2   | ma         |
| Maximum-Signal Grid-No.2 Current (Approx.) ..... | 10    | 8.5   | ma         |
| Plate Resistance (Approx.) .....                 | 13000 | 28000 | ohms       |
| Transconductance .....                           | 8000  | 8000  | $\mu$ mhos |
| Load Resistance .....                            | 2000  | 4000  | ohms       |
| Total Harmonic Distortion .....                  | 10    | 10    | per cent   |
| Maximum-Signal Power Output .....                | 2.1   | 3.8   | watts      |

## VACUUM RECTIFIER-DOUBLER

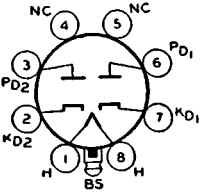

Lock-in type used as half-wave rectifier or voltage doubler in ac/dc receivers. Outline 20, OUTLINES SECTION. Tube requires lock-in socket. Heater volts (ac/dc), 50; amperes, 0.15. This type is electrically identical with glass-octal type 50Y6-GT and, except for heater rating, with glass-octal type 25Z6-GT. Refer to type 25Z6-GT for maximum ratings, typical operation, and curves. Type 50X6 is used principally for renewal purposes.

# 50X6

## VACUUM RECTIFIER-DOUBLER

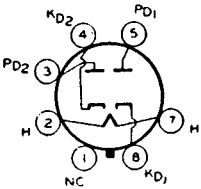

Glass octal type used as half-wave rectifier or voltage doubler in ac/dc receivers. This type is used particularly in "transformerless" receivers of either the ac/dc type or the voltage-doubler type. Outline 23, OUTLINES SECTION. This type may be supplied with pin No.1 omitted. Tube requires octal socket. Heater volts (ac/dc), 50; amperes, 0.15. Except for heater rating, this type is electrically identical with type 25Z6-GT.

# 50Y6-GT

## VACUUM RECTIFIER-DOUBLER

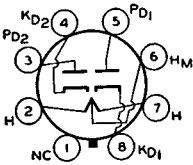

Glass octal type used as half-wave rectifier or voltage doubler in ac/dc receivers. This type is used particularly in "transformerless" receivers of either the ac/dc type or the voltage-doubler type. The heater is provided with a tap for operation of a panel lamp. Outline 23, OUTLINES SECTION. Tube requires octal socket. For maximum ratings and typical operation as

# 50Y7-GT

half-wave rectifier or voltage doubler without panel lamp, refer to glass octal type 25Z6-GT. When operated with a panel lamp and 250-ohm panel-lamp shunting resistor, ratings and typical operation are the same as for type 25Z6-GT, except that dc output current per plate is 65 ma. Type 50Y7-GT is used principally for renewal purposes.

|   |      |      |        |
|---|------|------|--------|
| <b>HEATER VOLTAGE (AC/DC):</b>          |      |      |        |
| ENTIRE HEATER (PINS 2 AND 7) .....      | 50   | *    |        |
| PANEL LAMP SECTION (PINS 6 AND 7) ..... | 7.5  | **   | volts  |
| <b>HEATER CURRENT:</b>                  |      |      |        |
| BETWEEN PINS 2 AND 7 .....              | 0.15 | -    | ampere |
| BETWEEN PINS 2 AND 6 .....              | -    | 0.15 | ampere |

\* Without panel lamp.

\*\* With No. 40 or No. 47 panel lamp.

## VACUUM RECTIFIER-DOUBLER

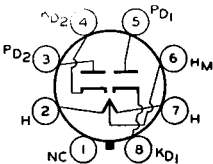

Glass octal type used as half-wave rectifier or voltage doubler in ac/dc receivers. Outline 33, OUTLINES SECTION. The heater is provided with a tap for operation of a panel lamp. Without panel lamp, heater volts (ac/dc) of entire heater (pins 2 and 7), 50; amperes, 0.15. With panel lamp, heater volts (ac/dc) of panel-lamp section (pins 6 and 7) with 0.15 ampere

# 50Z7-G

between pins 2 and 7), 2. Maximum ratings as rectifier or doubler: peak inverse plate volts, 700 *max*; peak plate ma. per plate, 400 *max*; dc output ma. per plate with panel lamp, 65 *max*; peak heater-cathode volts, 350 *max*; panel lamp section volts (pins 6 and 7), 2.5 *max*. This is a DISCONTINUED type listed for reference only.

**HIGH-MU TWIN POWER TRIODE**

53

Glass type used in output stage of ac-operated receivers as a class B power amplifier. Outline 38, OUTLINES SECTION. Tube requires medium seven-contact (0.855-inch pin-circle diameter) socket. Heater volts (ac/dc), 2.5; amperes, 2.0. Except for heater rating, this type is electrically identical with metal type 6N7. Type 53 is a DISCONTINUED type listed for reference only.

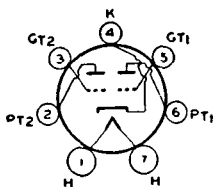

**TWIN DIODE—MEDIUM-MU TRIODE**

55

Glass type used as a combined detector, amplifier, and avc tube. Outline 36, OUTLINES SECTION. Tube requires six-contact socket. Heater volts (ac/dc), 2.5; amperes, 1.0. Except for heater rating, this type is electrically identical with glass type 85. Type 55 is a DISCONTINUED type listed for reference only.

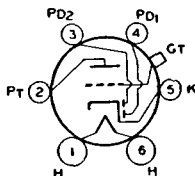

**MEDIUM-MU TRIODE**

56

Glass type used as detector, amplifier, or oscillator in ac-operated receivers. Outline 31 or 34, OUTLINES SECTION. Tube requires five-contact socket. Heater volts (ac/dc), 2.5; amperes, 1.0. Except for heater rating, this type is electrically identical with glass type 76. Type 56 is a DISCONTINUED type listed for reference only.

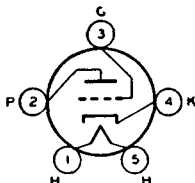

**SHARP-CUTOFF PENTODE**

57

Glass type used as biased detector in ac-operated receivers. Outline 40, OUTLINES SECTION. Tube requires six-contact socket. Heater volts (ac/dc), 2.5; amperes, 1.0. Except for heater rating and capacitances, this type is electrically identical with metal type 6J7. Type 57 is a DISCONTINUED type listed for reference only.

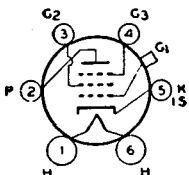

**REMOTE-CUTOFF PENTODE**

58

Glass type used in rf and if stages of radio receivers employing avc and as a mixer in superheterodyne circuits. Outline 40, OUTLINES SECTION. Tube requires six-contact socket. Heater volts (ac/dc), 2.5; amperes, 1.0. Except for heater ratings, this type is electrically identical with glass-octal type 6U7-G. Type 58 is a DISCONTINUED type listed for reference only.

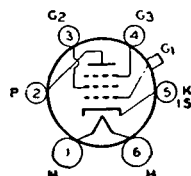

**TRIPLE-GRID POWER AMPLIFIER**

59

Glass type used in audio output stage of ac-operated receivers. Outline 43, OUTLINES SECTION. Tube requires medium seven-contact (0.855-inch, pin-circle diameter) socket. Heater volts (ac/dc), 2.5; amperes, 2.0. Typical operation as class A<sub>1</sub> amplifier (triode connection; grids No.2 and No.3 tied to plate): plate volts, 250 max; grid volts, -28; plate ma., 26;

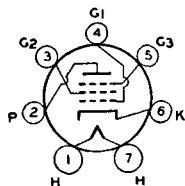
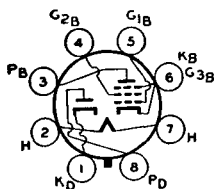

plate resistance, 2300 ohms; amplification factor, 6; transconductance, 2600; load resistance for maximum undistorted power output, 5000 ohms; undistorted output watts, 1.25. For typical operation as class A<sub>1</sub> amplifier (pentode connection; grid No.3 tied to cathode at socket), refer to type 6F6 with plate voltage of 250 volts. Type 59 is a DISCONTINUED type listed for reference only.





**RECTIFIER—BEAM POWER TUBE**

**70L7-GT**

Glass octal type used as combined half-wave rectifier and output amplifier in ac/dc receivers. Outline 27, OUTLINES SECTION. Tube requires octal socket. Heater volts (ac/dc), 70; amperes, 0.15. Maximum ratings of rectifier unit: peak inverse plate volts, 350; peak plate ma., 420; dc output ma., 70; peak heater-cathode volts, 175; minimum total effective

plate-supply impedance, 15 ohms. Typical operation and maximum ratings of beam power unit as class A<sub>1</sub> amplifier: plate and grid-No.2 volts, 110 (117 max); grid-No.1 volts, -7.5; plate ma., 40; grid-No.2 ma., 3; plate resistance, 15000 ohms; transconductance, 7500 μmhos; load resistance, 2000 ohms; output watts, 1.8; plate dissipation, 5 max watts; grid-No.2 input, 1 max watt. This type is used principally for renewal purposes.

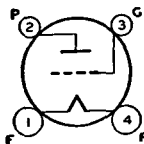

**POWER TRIODE**

**71-A**

Glass type used in output stage of audio-frequency amplifiers. Outline 38, OUTLINES SECTION. Tube requires four-contact socket. Filament volts (ac/dc), 5.0; amperes, 0.25. Characteristics as class A<sub>1</sub> amplifier: plate volts, 180 max; grid volts, -40.5; cathode resistor, 2150 ohms; plate ma., 20; plate resistance, 1750 ohms; amplification factor, 3; transconductance,

1700 μmhos; load resistance, 4800 ohms; undistorted output watts, 0.79. This type is used principally for renewal purposes.

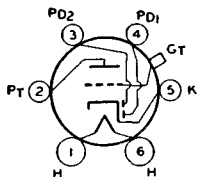

**TWIN DIODE—HIGH-MU TRIODE**

**75**

Glass type used as combined detector, amplifier, and avc tube in radio receivers. Outline 36, OUTLINES SECTION. Tube requires six-contact socket. Heater volts (ac/dc), 6.3; amperes, 0.3. Except for interelectrode capacitances and plate volts of 250 max, this type is identical electrically with metal type 6SQ7. Type 75 is used principally for renewal purposes.

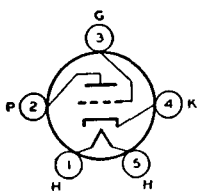

**MEDIUM-MU TRIODE**

**76**

Glass type used as voltage amplifier or detector in radio receivers. Outline 31 or 34, OUTLINES SECTION. Tube requires five-contact socket. Heater volts (ac/dc), 6.3; amperes, 0.3. Characteristics as class A<sub>1</sub> amplifier: plate volts, 250 max; grid volts, -13.5; plate ma., 5; plate resistance, 9500 ohms; transconductance, 1450 μmhos. This is a DISCONTINUED type listed for reference only.

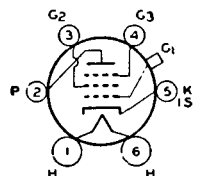

**SHARP-CUTOFF PENTODE**

**77**

Glass type used as biased detector or high-gain amplifier in radio receivers. Outline 36, OUTLINES SECTION. Tube requires six-contact socket. Heater volts (ac/dc), 6.3; amperes, 0.3. Except for capacitances and grid-No. 2 rating of 100 max volts, type 77 is electrically identical with metal type 6J7. Type 77 is used principally for renewal purposes.

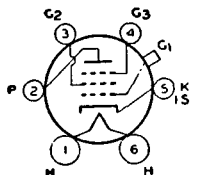

**REMOTE-CUTOFF PENTODE**

**78**

Glass type used in rf and if stages of radio receivers, particularly those employing avc. Outline 36, OUTLINES SECTION. Tube requires six-contact socket. Heater volts (ac/dc), 6.3; amperes, 0.3. Except for capacitances, this type is identical electrically with metal type 6K7. Type 78 is used principally for renewal purposes.

**HIGH-MU TWIN POWER TRIODE**

**79**

Glass type used in output stage of radio receivers as a class B power amplifier or a class A<sub>1</sub> driver. Outline 36, **OUTLINES SECTION**. Tube requires six-contact socket. Heater volts (ac/dc), 6.3; amperes, 0.6. Maximum ratings and typical operation as class B power amplifier: plate volts, 250 *max*; grid volts, 0; zero-signal plate ma., 10.5; effective load resistance

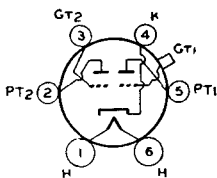

(plate-to-plate), 14000 ohms; output watts (approx.), 8; peak plate ma. per plate, 90 *max*; average plate dissipation, 11.5 watts *max*. This is a **DISCONTINUED** type listed for reference only.

**FULL-WAVE VACUUM RECTIFIER**

**80**

Glass type used in power supply of radio equipment having moderate direct-current requirements. Outline 38, **OUTLINES SECTION**. Tube requires four-contact socket and should

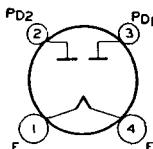

be mounted preferably in a vertical position. Horizontal mounting is permissible if pins 1 and 4 are in a horizontal plane. Filament volts (ac), 5.0; amperes, 2.0. For filament operation, refer to type 5U4-G. Type 80 is electrically identical with glass-octal type 5Y3-GT.

**HALF-WAVE VACUUM RECTIFIER**

**81**

Glass type used in power supply of radio receivers. Outline 45, **OUTLINES SECTION**. Tube requires four-contact socket and should be mounted preferably in a vertical position. Horizontal mounting is permissible if pins 1 and 4 are in a vertical plane. Filament volts (ac), 7.5; amperes, 1.25. Ratings as half-wave rectifier: peak inverse plate volts, 2000 *max*; peak plate ma., 500 *max*; dc output ma., 85 *max*. This is a **DISCONTINUED** type listed for reference only.

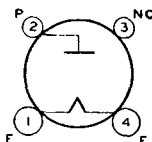

**FULL-WAVE MERCURY-VAPOR RECTIFIER**

**82  
83**

Glass types used to supply dc power of uniform voltage to receivers in which the rectified current requirements are subject to considerable variation. Outlines 38 and 48, respectively, **OUTLINES SECTION**. Tubes require four-contact socket and should be mounted in vertical position with base down. Type 82 is a **DISCONTINUED** type listed for reference only.

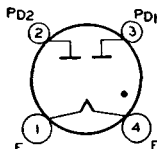

|                            |                |                |         |
|----------------------------|----------------|----------------|---------|
|                            | <i>Type 82</i> |                |         |
| FILAMENT VOLTAGE (AC)..... | 2.5            |                |         |
| FILAMENT CURRENT.....      | 3              |                |         |
|                            |                | <i>Type 83</i> |         |
|                            |                | 5              | volts   |
|                            |                | 3              | amperes |

|  |                            |                 |        |
|--|----------------------------|-----------------|--------|
| <b>Maximum Ratings:</b>                  | <b>FULL-WAVE RECTIFIER</b> |                 |        |
| PEAK INVERSE PLATE VOLTAGE.....          | 1550 <i>max</i>            | 1550 <i>max</i> | volts  |
| PEAK PLATE CURRENT PER PLATE.....        | 0.6 <i>max</i>             | 1.0 <i>max</i>  | ampere |
| DC OUTPUT CURRENT.....                   | 115 <i>max</i>             | 225 <i>max</i>  | ma     |
| CONDENSED-MERCURY TEMPERATURE RANGE..... | 24 to 60                   | 20 to 60        | °C     |

|   |     |     |       |
|---|-----|-----|-------|
| <b>Typical Operation (With Capacitor-Input Filter):</b>       |     |     |       |
| AC Plate-to-Plate Supply Voltage (rms).....                   | 900 | 900 | volts |
| Minimum Total Effective Plate-Supply Impedance per Plate..... | 50  | 50  | ohms  |
| DC Output Current.....  | 115 | 225 | ma    |

## Typical Operation (With Choke-Input Filter):

|   |      |      |         |
|---|------|------|---------|
| AC Plate-to-Plate Supply Voltage (rms)..... | 1100 | 1100 | volts   |
| Minimum Filter-Input Choke.....             | 6    | 3    | henries |
| DC Output Current.....                      | 115  | 225  | ma      |

† When a filter-input capacitor larger than 40  $\mu$ f is used, it may be necessary to use more plate-supply impedance than the minimum value shown to limit the peak plate current to the rated value.

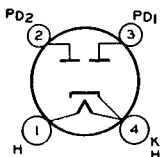

### FULL-WAVE VACUUM RECTIFIER

Glass type used in power supply of radio equipment having high dc requirements. Outline 38, OUTLINES SECTION. Tube requires four-contact socket. Heater volts (ac), 5.0; amperes, 2. This type is identical electrically with glass-octal type 5V4-G. Type 83-v is used principally for renewal purposes.

## 83-v

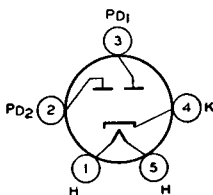

### FULL-WAVE VACUUM RECTIFIER

Glass type used in power supply of automobile and ac-operated radio receivers. Outline 31 or 34, OUTLINES SECTION. Tube requires five-contact socket. Heater volts (ac/dc), 6.3; amperes, 0.5. Maximum ratings: peak inverse plate volts, 1250 *max*; peak plate ma., 180 *max*; dc output ma., 60 *max*; peak heater-cathode volts, 450 *max*. Typical operation with capacitor-input filter: ac plate-to-plate supply volts (rms), 650; minimum total effective plate-supply impedance per plate, 150 ohms; dc output ma., 60. Typical operation with choke-input filter: ac plate-to-plate supply volts (rms), 900; minimum filter-input choke, 10 henries; dc output ma., 60. This type is used principally for renewal purposes.

## 84/6Z4

capacitor-input filter: ac plate-to-plate supply volts (rms), 650; minimum total effective plate-supply impedance per plate, 150 ohms; dc output ma., 60. Typical operation with choke-input filter: ac plate-to-plate supply volts (rms), 900; minimum filter-input choke, 10 henries; dc output ma., 60. This type is used principally for renewal purposes.

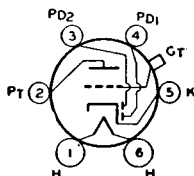

### TWIN DIODE—MEDIUM-MU TRIODE

Glass type used as a combined detector, amplifier, and avc tube. Outline 36, OUTLINES SECTION. Tube requires six-contact socket. Heater volts (ac/dc), 6.3; amperes, 0.3. Characteristics of triode unit as class A<sub>1</sub> amplifier: plate volts, 250 *max*; grid volts, -20; amplification factor, 8.3; transconductance, 1100  $\mu$ mhos; plate ma., 8.0; plate resistance, 7500 ohms; load

## 85

resistance, 20000 ohms; output watts, 0.35. This is a DISCONTINUED type listed for reference only.

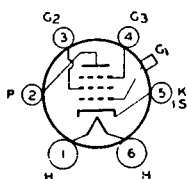

### TRIPLE-GRID POWER AMPLIFIER

Glass type used in output stage of radio receivers. Outline 84, OUTLINES SECTION. Tube requires six-contact socket. Heater volts (ac/dc), 6.3; amperes, 0.4. Maximum ratings as class B amplifier (triode connection): plate volts, 250 *max*; peak plate ma. per tube, 90 *max*; average grid input of grids No.1 and No.2 tied together, 0.35 *max* watt. This is a DISCONTINUED type listed for reference only.

## 89

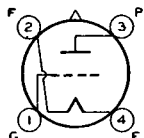

### DETECTOR AMPLIFIER TRIODE

Glass types used as detector or amplifier in battery-operated receivers. Filament volts (dc), 3.0 to 3.3; amperes, 0.060 to 0.063. Characteristics as class A<sub>1</sub> amplifier: plate volts, 90 *max*; grid volts, -4.5; amplification factor, 6.6; transconductance, 425  $\mu$ mhos; plate ma., 2.5. Operation as grid-resistor detector: plate volts, 45; grid resistor, 0.25 to 5 megohms; grid capacitor, 250  $\mu$ f; grid return to (-) filament. Operation as biased detector: plate volts, 90 *max*; grid volts (approx.), -10.5. These are DISCONTINUED types listed for reference only.

## V99

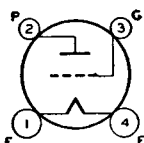

## X99

**DETECTOR AMPLIFIER TRIODE**

Glass type used as detector or amplifier in battery-operated receivers. Outline 38, OUTLINES SECTION. Filament volts (dc), 5.0; amperes, 0.25. Operation as class A<sub>1</sub> amplifier: plate volts, 180 max; grid volts, -13.5; amplification factor, 8.5; transconductance, 1800  $\mu$ mhos; plate ma., 7.7; load resistance, 10650 ohms; output watts, 0.285. Operation as biased detector: plate volts, 180; grid volts, -21. This is a DISCONTINUED type listed for reference only.

**112-A**

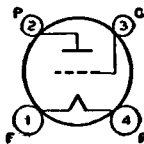

**RECTIFIER—BEAM POWER TUBE**

Glass octal type used as combined half-wave rectifier and output amplifier in ac/dc receivers. Outline 27, OUTLINES SECTION. Tube requires octal socket. Heater volts (ac/dc), 117; amperes, 0.09. For ratings and operation of rectifier unit, refer to type 117N7-GT. Type 117L7/M7-GT is used principally for renewal purposes.

**117L7/  
M7-GT**

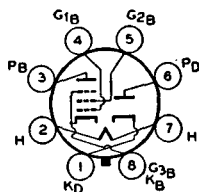

**AMPLIFIER UNIT AS CLASS A<sub>1</sub> AMPLIFIER**

**Maximum Ratings:**

|                                 |         |       |
|---------------------------------|---------|-------|
| PLATE VOLTAGE.....              | 117 max | volts |
| GRID-NO.2 (SCREEN) VOLTAGE..... | 117 max | volts |
| PLATE INPUT.....                | 6.0 max | watts |
| GRID-NO.2 DISSIPATION.....      | 1.0 max | watt  |

**Typical Operation:**

|   |       |            |
|---|-------|------------|
| Plate Voltage.....                              | 105   | volts      |
| Grid-No.2 Voltage.....                          | 105   | volts      |
| Grid-No.1 (Control-Grid) Voltage.....           | -5.2  | volts      |
| Peak AF Grid-No.1 Voltage.....                  | 5.2   | volts      |
| Zero-Signal Plate Current.....                  | 48    | ma         |
| Maximum-Signal Plate Current.....               | 43    | ma         |
| Zero-Signal Grid-No.2 Current (Approx.).....    | 4     | ma         |
| Maximum-Signal Grid-No.2 Current (Approx.)..... | 5.5   | ma         |
| Plate Resistance (Approx.).....                 | 17000 | ohms       |
| Transconductance.....                           | 5300  | $\mu$ mhos |
| Load Resistance.....                            | 4000  | ohms       |
| Total Harmonic Distortion.....                  | 5     | per cent   |
| Maximum-Signal Power Output.....                | 0.85  | watt       |

**RECTIFIER—BEAM POWER TUBE**

Glass octal type used as combined half-wave rectifier and output amplifier in ac/dc receivers. Outline 27, OUTLINES SECTION. Tube requires octal socket and may be mounted in any position. Heater volts (ac/dc), 117; amperes, 0.09. This type is used principally for renewal purposes.

**117N7-GT**

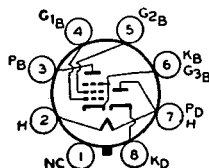

**RECTIFIER UNIT AS HALF-WAVE RECTIFIER**

**Maximum Ratings:**

|  |         |       |
|--|---------|-------|
| PEAK INVERSE PLATE VOLTAGE.....  | 350 max | volts |
| PEAK PLATE CURRENT.....  | 450 max | ma    |
| DC OUTPUT CURRENT.....   | 75 max  | ma    |
| PEAK HEATER-CATHODE VOLTAGE:<br>Heater negative with respect to cathode..... | 175 max | volts |

### Typical Operation (Capacitor-Input Filter):

|  |     |         |
|--|-----|---------|
| AC Plate-Supply Voltage (rms).....                   | 117 | volts   |
| Filter-Input Capacitor.....                          | 40  | $\mu$ f |
| Minimum Total Effective Plate-Supply Impedance†..... | 15  | ohms    |
| DC Output Current.....                               | 75  | ma      |
| DC Output Voltage at Input to Filter (Approx.).....  | 122 | volts   |

†When a filter-input capacitor larger than 40  $\mu$ f is used, it may be necessary to use more plate-supply impedance than the minimum value shown to limit the peak plate current to the rated value.

### AMPLIFIER UNIT AS CLASS A<sub>1</sub> AMPLIFIER

#### Maximum Ratings:

|                                 |         |       |
|---------------------------------|---------|-------|
| PLATE VOLTAGE.....              | 117 max | volts |
| GRID-NO.2 (SCREEN) VOLTAGE..... | 117 max | volts |
| PLATE DISSIPATION.....          | 5.5 max | watts |
| GRID-NO.2 INPUT.....            | 1.0 max | watt  |

#### Typical Operation:

|                                       |       |            |
|---------------------------------------|-------|------------|
| Plate Voltage.....                    | 100   | volts      |
| Grid-No.2 Voltage.....                | 100   | volts      |
| Grid-No.1 (Control-Grid) Voltage..... | -6    | volts      |
| Peak AF Grid-No.1 Voltage.....        | 6     | volts      |
| Zero-Signal Plate Current.....        | 51    | ma         |
| Zero-Signal Grid-No.2 Current.....    | 5     | ma         |
| Plate Resistance (Approx.).....       | 16000 | ohms       |
| Transconductance.....                 | 7000  | $\mu$ mhos |
| Load Resistance.....                  | 3000  | ohms       |
| Total Harmonic Distortion.....        | 6     | per cent   |
| Maximum-Signal Power Output.....      | 1.2   | watts      |

#### Maximum Circuit Values (For maximum rated conditions):

|                                 |          |        |
|---------------------------------|----------|--------|
| Grid-No.1-Circuit Resistance:   |          |        |
| For fixed-bias operation.....   | 0.25 max | megohm |
| For cathode-bias operation..... | 1.0 max  | megohm |

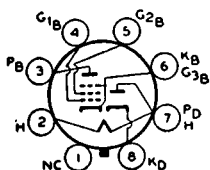

### RECTIFIER—BEAM POWER TUBE

Glass octal type used as combined half-wave rectifier and output tube. Outline 27, OUTLINES SECTION. Tube requires octal socket. Heater volts (ac/dc), 117; amperes, glass-octal type 117L7/M7-GT. Type 117P7-GT is used principally for renewal purposes.

## 117P7-GT

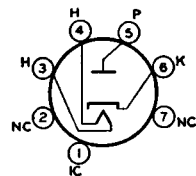

### HALF-WAVE VACUUM RECTIFIER

Miniature type used in power supply of ac/dc/battery radio receivers. The heater is designed for operation directly across a 117-volt ac or dc supply line.

## 117Z3

|                             |      |        |
|-----------------------------|------|--------|
| HEATER VOLTAGE (AC/DC)..... | 117  | volts  |
| HEATER CURRENT.....         | 0.04 | ampere |

### HALF-WAVE RECTIFIER

#### Maximum Ratings:

|  |         |       |
|--|---------|-------|
| PEAK INVERSE PLATE VOLTAGE.....              | 330 max | volts |
| PEAK PLATE CURRENT.....                      | 540 max | ma    |
| DC OUTPUT CURRENT.....                       | 90 max  | ma    |
| PEAK HEATER-CATHODE VOLTAGE:                 |         |       |
| Heater negative with respect to cathode..... | 175 max | volts |
| Heater positive with respect to cathode..... | 100 max | volts |

## Typical Operation (Capacitor-Input to Filter):

|   |     |         |
|---|-----|---------|
| AC Plate-Supply Voltage (rms) .....                   | 117 | volts   |
| Filter-Input Capacitor .....                          | 30  | $\mu$ f |
| Minimum Total Effective Plate-Supply Impedance† ..... | 20  | ohms    |
| DC Output Current .....                               | 90  | ma      |
| DC Output Voltage at Input to Filter (Approx):        |     |         |
| At half-load current (45 ma.) .....                   | 130 | volts   |
| At full-load current (90 ma.) .....                   | 110 | volts   |
| Voltage Regulation (Approx.):                         |     |         |
| Half-load to full-load current .....                  | 20  | volts   |

†When a filter-input capacitor larger than 40  $\mu$ f is used, it may be necessary to use more plate-supply impedance than the minimum value shown to limit the peak plate current to the rated value.

## INSTALLATION AND APPLICATION

Type 117Z3 requires miniature seven-contact socket and may be mounted in any position. Outline 16, OUTLINES SECTION. It is especially important that this tube, like other power-handling tubes, should be adequately ventilated.

Refer to the CIRCUITS SECTION for typical application of the 117Z3 as a half-wave rectifier in a portable 3-way superheterodyne receiver.

## OPERATION CHARACTERISTICS

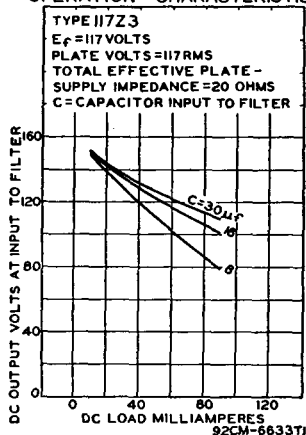

## HALF-WAVE VACUUM RECTIFIER

Glass octal type used in power supply of ac/dc/battery radio receivers. Dimensions: maximum overall length, 3 inches; maximum seated height, 2 $\frac{3}{4}$  inches; maximum diameter, 1-5/16 inches; T-9 bulb; intermediate-shell octal 7-pin base. This type may be supplied with pin No.1 omitted. Tube requires octal socket. Heater volts (ac/dc), 117; amperes, 0.04. Maximum ratings as half-wave rectifier: peak inverse

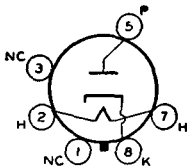
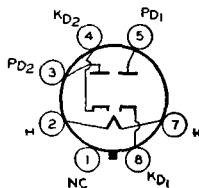

plate volts, 350 *max*; peak plate ma., 540 *max*; peak heater-cathode volts, 175 *max*. Typical operation with capacitor-input filter: ac plate supply volts (rms), 117; minimum total effective plate-supply impedance, 30 ohms; dc output ma., 90. This is a DISCONTINUED type listed for reference only.

## VACUUM RECTIFIER-DOUBLER

Glass octal type used as half-wave rectifier or voltage doubler in ac/dc receivers. Outline 23, OUTLINES SECTION. Tube requires octal socket and may be mounted in any position. This type may be supplied with pin No.1 omitted. Heater volts (ac/dc), 117; amperes, 0.075. This type is used principally for renewal purposes.



## 117Z6-GT

## HALF-WAVE RECTIFIER

### Maximum Ratings:

|                                    |                |       |
|------------------------------------|----------------|-------|
| PEAK INVERSE PLATE VOLTAGE .....   | 700 <i>max</i> | volts |
| PEAK PLATE CURRENT PER PLATE ..... | 360 <i>max</i> | ma    |
| DC OUTPUT CURRENT PER PLATE .....  | 60 <i>max</i>  | ma    |
| PEAK HEATER-CATHODE VOLTAGE .....  | 350 <i>max</i> | volts |

## Typical Operation (Capacitor-Input Filter):<sup>o</sup>

|  |     |     |     |         |
|--|-----|-----|-----|---------|
| AC Plate-Supply Voltage per Plate (rms) . . . . .                                | 117 | 150 | 235 | volts   |
| Filter-Input Capacitor . . . . .   | 40  | 40  | 40  | $\mu$ f |
| Minimum Total Effective Plate-Supply Impedance<br>per Plate $\ddagger$ . . . . . | 15  | 40  | 100 | ohms    |
| DC Output Current per Plate . . . . .  | 60  | 60  | 60  | ma      |

## VOLTAGE DOUBLER

### Maximum Ratings:

(Same as for Half-Wave Rectifier)

### Typical Operation:

|   | <i>Half-Wave</i> | <i>Full-Wave</i> |         |
|---|------------------|------------------|---------|
| AC Plate-Supply Voltage per Plate (rms) . . . . .                             | 117              | 117              | volts   |
| Filter-Input Capacitor . . . . .  | 40               | 40               | $\mu$ f |
| Minimum Total Effective Plate-Supply Impedance per Plate $\ddagger$ . . . . . | 30               | 15               | ohms    |
| DC Output Current . . . . .   | 60               | 60               | ma      |

<sup>o</sup> In half-wave rectifier service, the two units may be used separately or in parallel.

$\ddagger$  When a filter-input capacitor larger than 40 $\mu$ f is used, it may be necessary to use more plate-supply impedance than the minimum value shown to limit the peak plate current to the rated value.

## POWER TRIODE

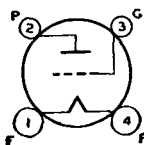

Glass type used in output stage of radio receivers. Outline 38, OUTLINES SECTION. Filament volts (ac/dc), 5.0; amperes, 1.25. Characteristics: plate volts, 250; grid volts, -60; plate ma., 30; amplification factor, 3; plate resistance, 1750 ohms; transconductance, 1700  $\mu$ mhos; load resistance, 5000 ohms; output watts, 1.8. This is a DISCONTINUED type listed for reference only.

# 183/483

## DETECTOR AMPLIFIER TRIODE

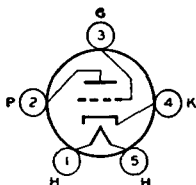

Glass type used as detector or class A<sub>1</sub> amplifier in radio receivers. Outline 34, OUTLINES SECTION. Heater volts (ac/dc), 3; amperes, 1.25. Characteristics: plate volts, 180; grid volts, -9; amplification factor, 12.5; plate resistance, 8900 ohms; transconductance, 1400  $\mu$ mhos; plate ma., 5.8. This is a DISCONTINUED type listed for reference only.

# 485

## CURRENT REGULATORS



Constant-current regulating devices (ballast tubes) used in radio receivers. Bases fit the standard mogul screw socket and tubes may be mounted in any position. Tubes operate at high bulb temperature. They must be surrounded by a protective metal ventilating stack. Operating conditions: voltage range, 40 to 60 volts; ambient temperature, 150°F; operating current for the 876, 1.7 amperes; for the 886, 2.05 amperes. These are DISCONTINUED types listed for reference only.

# 876

# 886

# RCA Kinescope

| Type                         | Envelope  | Facings <sup>d</sup> | External Conductive Coating |          | Facing Method | Deflection Method | Ion-Trap Magnet | Approx. Deflection Angle <sup>e</sup> Degrees | Marking Dimensions Inches |                   |                  |                  | Mark Length (mm) |
|------------------------------|---|----------------------|-----------------------------|----------|---------------|-------------------|-----------------|---|---------------------------|-------------------|------------------|------------------|------------------|
|                              |   |                      | Min. mil                    | Max. mil |               |                   |                 |   | Overall Length            | Envelope Diameter | Width            | Height           |                  |
| <b>Black-and-White Types</b> |   |                      |                             |          |               |                   |                 |   |                           |                   |                  |                  |                  |
| 3KP4                         | Glass Round   | Clear                | None                        | None     | E             | E O               | None            | None  | 11 $\frac{1}{2}$          | 3 $\frac{1}{2}$   | —                | —                | —                |
| 5TP4 <sup>a</sup>            | Glass Round   | Clear                | 500                         | 100      | E             | M                 | †               | 50  | 12 $\frac{1}{2}$          | 5 $\frac{1}{2}$   | —                | —                | 7 $\frac{1}{2}$  |
| 7DP4                         | Glass Round   | Clear                | 1500                        | 400      | E             | M                 | Double          | 50  | 14 $\frac{1}{2}$          | 7 $\frac{1}{2}$   | —                | —                | 8 $\frac{1}{2}$  |
| 7JP4                         | Glass Round   | Clear                | None                        | None     | E             | E O               | None            | None  | 14 $\frac{1}{2}$          | 7 $\frac{1}{2}$   | —                | —                | —                |
| 9AP4                         | Glass Round   | Clear                | None                        | None     | E             | M                 | None            | 40  | 21 $\frac{1}{2}$          | 9 $\frac{1}{2}$   | —                | —                | 10               |
| 10BP4                        | Same as 10BP4-A, except has clear glass faceplate.          |                      |                             |          |               |                   |                 |   |                           |                   |                  |                  |                  |
| 10BP4-A                      | Glass Round   | Filterglass          | 2500                        | 500      | M             | M                 | Double          | 52  | 18                        | 10 $\frac{1}{2}$  | —                | —                | 8 $\frac{1}{2}$  |
| 10FP4-A                      | Glass Round   | Filterglass          | 2500                        | 500      | M             | M                 | †               | 50  | 18                        | 10 $\frac{1}{2}$  | —                | —                | 8 $\frac{1}{2}$  |
| 12AP4                        | Glass Round   | Clear                | None                        | None     | E             | M                 | None            | 40  | 25 $\frac{1}{2}$          | 12 $\frac{1}{2}$  | —                | —                | 9 $\frac{1}{2}$  |
| 12KP4-A                      | Glass Round   | Filterglass          | 2500                        | 500      | M             | M                 | †               | 54  | 18                        | 12 $\frac{1}{2}$  | —                | —                | 7 $\frac{1}{2}$  |
| 12LP4                        | Same as 12LP4-A, except has clear glass faceplate.          |                      |                             |          |               |                   |                 |   |                           |                   |                  |                  |                  |
| 12LP4-A                      | Glass Round   | Filterglass          | 2500                        | 750      | M             | M                 | Double          | 57  | 19 $\frac{1}{2}$          | 12 $\frac{1}{2}$  | —                | —                | 8 $\frac{1}{2}$  |
| 14CP4                        | Glass Rectangular   | Filterglass          | 2000                        | 750      | M             | M                 | Single          | 65  | 17 $\frac{1}{2}$          | 13 $\frac{1}{2}$  | 12 $\frac{1}{2}$ | 9 $\frac{1}{2}$  | 7 $\frac{1}{2}$  |
| 14EP4                        | Glass Rectangular   | Filterglass          | 2000                        | 750      | M             | M                 | Single          | 65  | 16 $\frac{1}{2}$          | 13 $\frac{1}{2}$  | 12 $\frac{1}{2}$ | 9 $\frac{1}{2}$  | 7 $\frac{1}{2}$  |
| 14HP4                        | Glass Rectangular   | Filterglass          | 2000                        | 750      | E             | M                 | Single          | 65  | 17 $\frac{1}{2}$          | 13 $\frac{1}{2}$  | 12 $\frac{1}{2}$ | 9 $\frac{1}{2}$  | 7 $\frac{1}{2}$  |
| 16AP4                        | Same as 16AP4-A, except has clear glass faceplate.          |                      |                             |          |               |                   |                 |   |                           |                   |                  |                  |                  |
| 16AP4-A                      | Metal Round   | Filterglass          | None                        | None     | M             | M                 | Double          | 53  | 22 $\frac{1}{2}$          | 16                | —                | —                | 7 $\frac{1}{2}$  |
| 16DP4-A                      | Glass Round   | Filterglass          | None                        | None     | M             | M                 | Double          | 60  | 21                        | 16                | —                | —                | 7 $\frac{1}{2}$  |
| 16GP4                        | Same as 16GP4-B, except has Filterglass faceplate.          |                      |                             |          |               |                   |                 |   |                           |                   |                  |                  |                  |
| 16GP4-A                      | Same as 16GP4-B, except has clear glass faceplate.          |                      |                             |          |               |                   |                 |   |                           |                   |                  |                  |                  |
| 16GP4-B                      | Metal Round   | Frosted Filterglass  | None                        | None     | M             | M                 | Single          | 70  | 17 $\frac{1}{2}$          | 16                | —                | —                | 6 $\frac{1}{2}$  |
| 16GP4-C                      | Same as 16GP4-B, except has frosted clear glass faceplate.  |                      |                             |          |               |                   |                 |   |                           |                   |                  |                  |                  |
| 16KP4                        | Glass Rectangular   | Filterglass          | 1500                        | 750      | M             | M                 | Single          | 65  | 19 $\frac{1}{2}$          | 16 $\frac{1}{2}$  | 14 $\frac{1}{2}$ | 11 $\frac{1}{2}$ | 7 $\frac{1}{2}$  |
| 16LP4-A                      | Glass Round   | Filterglass          | 2000                        | 750      | M             | M                 | Double          | 52  | 22 $\frac{1}{2}$          | 16                | —                | —                | 7 $\frac{1}{2}$  |
| 16RP4                        | Glass Rectangular   | Filterglass          | 2000                        | 750      | M             | M                 | Single          | 65  | 19 $\frac{1}{2}$          | 16 $\frac{1}{2}$  | 14 $\frac{1}{2}$ | 11 $\frac{1}{2}$ | 7 $\frac{1}{2}$  |
| 16TP4                        | Glass Rectangular   | Filterglass          | 2000                        | 750      | M             | M                 | Single          | 65  | 18 $\frac{1}{2}$          | 16 $\frac{1}{2}$  | 14 $\frac{1}{2}$ | 11 $\frac{1}{2}$ | 6 $\frac{1}{2}$  |
| 16WP4-A                      | Glass Round   | Filterglass          | 1500                        | 750      | M             | M                 | Double          | 70  | 18 $\frac{1}{2}$          | 16                | —                | —                | 7 $\frac{1}{2}$  |
| 17AVP4                       | Glass Rectangular   | Filterglass          | 1500                        | 750      | E             | M                 | Single          | 85*   | 16                        | 16 $\frac{1}{2}$  | 15 $\frac{1}{2}$ | 12 $\frac{1}{2}$ | 6 $\frac{1}{2}$  |
| 17BP4-A                      | Glass Rectangular   | Filterglass          | 1500                        | 750      | M             | M                 | Single          | 65  | 19 $\frac{1}{2}$          | 16 $\frac{1}{2}$  | 15 $\frac{1}{2}$ | 12 $\frac{1}{2}$ | 7 $\frac{1}{2}$  |
| 17CP4                        | Metal Rectangular   | Frosted Filterglass  | None                        | None     | M             | M                 | Single          | 66  | 19                        | 17                | 16 $\frac{1}{2}$ | 12 $\frac{1}{2}$ | 7 $\frac{1}{2}$  |
| 17CP4-A                      | Same as 17CP4, except has Filterglass faceplate.            |                      |                             |          |               |                   |                 |   |                           |                   |                  |                  |                  |
| 17GP4                        | Metal Rectangular   | Frosted Filterglass  | None                        | None     | E             | M                 | Single          | 66  | 19 $\frac{1}{2}$          | 17                | 16 $\frac{1}{2}$ | 12 $\frac{1}{2}$ | 7 $\frac{1}{2}$  |
| 17HP4                        | Glass Rectangular   | Filterglass          | 1500                        | 750      | E             | M                 | Single          | 65  | 19 $\frac{1}{2}$          | 16 $\frac{1}{2}$  | 15 $\frac{1}{2}$ | 12 $\frac{1}{2}$ | 7 $\frac{1}{2}$  |
| 17JP4                        | Glass Rectangular   | Filterglass          | 750                         | 500      | M             | M                 | Single          | 65  | 19 $\frac{1}{2}$          | 16 $\frac{1}{2}$  | 15 $\frac{1}{2}$ | 12 $\frac{1}{2}$ | 7 $\frac{1}{2}$  |
| 17LP4                        | Glass Rectangular   | Filterglass**        | 1500                        | 750      | E             | M                 | Single          | 65  | 19 $\frac{1}{2}$          | 16 $\frac{1}{2}$  | 15 $\frac{1}{2}$ | 12 $\frac{1}{2}$ | 7 $\frac{1}{2}$  |
| 17QP4                        | Glass Rectangular   | Filterglass**        | 1500                        | 750      | M             | M                 | Single          | 65  | 19 $\frac{1}{2}$          | 16 $\frac{1}{2}$  | 15 $\frac{1}{2}$ | 12 $\frac{1}{2}$ | 7 $\frac{1}{2}$  |
| 17TP4                        | Metal Rectangular   | Frosted Filterglass  | None                        | None     | E             | M                 | Single          | 66  | 19 $\frac{1}{2}$          | 17                | 16 $\frac{1}{2}$ | 12 $\frac{1}{2}$ | 7 $\frac{1}{2}$  |
| 19AP4                        | Same as 19AP4-B, except has clear glass faceplate.          |                      |                             |          |               |                   |                 |   |                           |                   |                  |                  |                  |
| 19AP4-A                      | Same as 19AP4-B, except has Filterglass faceplate.          |                      |                             |          |               |                   |                 |   |                           |                   |                  |                  |                  |
| 19AP4-B                      | Metal Round   | Frosted Filterglass  | None                        | None     | M             | M                 | Single          | 66  | 22                        | 18 $\frac{1}{2}$  | —                | —                | 7 $\frac{1}{2}$  |
| 19AP4-D                      | Same as 19AP4-B, except has frosted clear glass faceplate.  |                      |                             |          |               |                   |                 |   |                           |                   |                  |                  |                  |
| 20CP4                        | Glass Rectangular   | Filterglass          | None                        | None     | M             | M                 | Single          | 66  | 21 $\frac{1}{2}$          | 20 $\frac{1}{2}$  | 18 $\frac{1}{2}$ | 15 $\frac{1}{2}$ | 7 $\frac{1}{2}$  |
| 20MP4                        | Glass Rectangular   | Filterglass          | 750                         | 500      | E             | M                 | Single          | 66  | 22 $\frac{1}{2}$          | 20 $\frac{1}{2}$  | 18 $\frac{1}{2}$ | 15 $\frac{1}{2}$ | 7 $\frac{1}{2}$  |
| 21ALP4-A                     | Glass Rectangular   | Filterglass          | 750                         | 500      | E             | M                 | Single          | 85*   | 20 $\frac{1}{2}$          | 21 $\frac{1}{2}$  | 20 $\frac{1}{2}$ | 16 $\frac{1}{2}$ | 7 $\frac{1}{2}$  |
| 21AP4                        | Metal Rectangular   | Frosted Filterglass  | None                        | None     | M             | M                 | Single          | 66  | 22 $\frac{1}{2}$          | 21                | 19 $\frac{1}{2}$ | 15 $\frac{1}{2}$ | 7 $\frac{1}{2}$  |
| 21EP4                        | Same as 21EP4-A, except has no external conductive coating. |                      |                             |          |               |                   |                 |   |                           |                   |                  |                  |                  |
| 21EP4-A                      | Glass Rectangular   | Filterglass**        | 750                         | 500      | M             | M                 | Single          | 65  | 23 $\frac{1}{2}$          | 21 $\frac{1}{2}$  | 20 $\frac{1}{2}$ | 15 $\frac{1}{2}$ | 7 $\frac{1}{2}$  |
| 21FP4-A                      | Glass Rectangular   | Filterglass**        | 750                         | 500      | E             | M                 | Single          | 65  | 23 $\frac{1}{2}$          | 21 $\frac{1}{2}$  | 20 $\frac{1}{2}$ | 15 $\frac{1}{2}$ | 7 $\frac{1}{2}$  |
| 21MP4                        | Metal Rectangular   | Frosted Filterglass  | None                        | None     | E             | M                 | Single          | 66  | 22 $\frac{1}{2}$          | 21                | 19 $\frac{1}{2}$ | 15 $\frac{1}{2}$ | 7 $\frac{1}{2}$  |
| 21YP4                        | Glass Rectangular   | Filterglass          | 750                         | 500      | E             | M                 | Single          | 65  | 23 $\frac{1}{2}$          | 21 $\frac{1}{2}$  | 20 $\frac{1}{2}$ | 15 $\frac{1}{2}$ | 7 $\frac{1}{2}$  |
| 21YP4-A                      | Same as 21YP4, except has metal-backed screen.              |                      |                             |          |               |                   |                 |   |                           |                   |                  |                  |                  |
| 21ZP4-A                      | Glass Rectangular   | Filterglass          | 750                         | 500      | M             | M                 | Single          | 65  | 23 $\frac{1}{2}$          | 21 $\frac{1}{2}$  | 20 $\frac{1}{2}$ | 15 $\frac{1}{2}$ | 7 $\frac{1}{2}$  |
| 21ZP4-B                      | Same as 21ZP4-A, except has metal-backed screen.            |                      |                             |          |               |                   |                 |   |                           |                   |                  |                  |                  |
| 24CP4-A                      | Glass Rectangular   | Filterglass          | 750                         | 500      | M             | M                 | Single          | 83*   | 21 $\frac{1}{2}$          | 24 $\frac{1}{2}$  | 22 $\frac{1}{2}$ | 19               | 7 $\frac{1}{2}$  |
| 27MP4                        | Metal Rectangular   | Frosted Filterglass  | None                        | None     | M             | M                 | Single          | 85*   | 22 $\frac{1}{2}$          | 27 $\frac{1}{2}$  | 25 $\frac{1}{2}$ | 20 $\frac{1}{2}$ | 7 $\frac{1}{2}$  |
| <b>Color Types</b>           |   |                      |                             |          |               |                   |                 |   |                           |                   |                  |                  |                  |
| 15GP22                       | Glass Round   | Clear                | 3000                        | 1500     | E             | M                 | †               | 45  | 26 $\frac{1}{2}$          | 14 $\frac{1}{2}$  | —                | —                | 10 $\frac{1}{2}$ |

For notes and basing diagrams, see page 248 .



# Characteristics Chart

| Minimum Screen Size Index                                 | High Voltage Terminal | Rating | Maximum Ratings                                   |                        |                             |                                  | Typical Operating Conditions   |                              |                 |                           | RCA Type |
|---|-----------------------|--------|---|------------------------|-----------------------------|----------------------------------|--|------------------------------|-----------------|---------------------------|----------|
|   |                       |        | First High Voltage Electrode (V <sub>100%</sub> ) | Forward Electrode Puls | Grid-No. 1 V <sub>10%</sub> | Grid-No. 1 Bias V <sub>10%</sub> | First High Voltage Electrode (V <sub>100%</sub> )                      | Forward Electrode Puls       | Grid-No. 1 Puls | Grid-No. 1 Puls           |          |
| <b>Black-and-White Types</b>                              |                       |        |   |                        |                             |                                  |  |                              |                 |                           |          |
| 2½ Diam.  | Base Pin              | A      | 2500  | 1000                   | ∞                           | 200                              | 2000   | 320 to 600                   | ∞               | -38 to -90                | 3KP4     |
| 4½ Diam.  | Small Cavity Cap      | B      | 27000   | 6000                   | 350                         | 150                              | 27000  | 4320 to 5400                 | 200             | -42 to -98                | 5TP4*    |
| 6 Diam.   | Small Cavity Cap      | B      | 8000  | 2400                   | 410                         | 125                              | 6000   | 1200 to 1650                 | 250             | -27 to -63                | 7DP4     |
| 6 Diam.   | Base Pin              | C      | 6000  | 2800                   | ∞                           | 200                              | 6000   | 1620 to 2400                 | ∞               | -72 to -168               | 7JP4     |
| 7½ Diam.  | Medium Cap            | D      | 7000  | 2000                   | 300                         | 125                              | 7000   | 1190 to 1790                 | 250             | -20 to -60                | 9AP4     |
| Ratings and characteristics are same as for type 10BP4-A. |                       |        |   |                        |                             |                                  |  |                              |                 |                           |          |
| 9½ Diam.  | Small Cavity Cap      | E      | 12000   | —                      | 410                         | 125                              | 8000 to 12000  | —                            | 250             | -27 to -63                | 10BP4-A  |
| 9½ Diam.  | Small Cavity Cap      | E      | 12000   | —                      | 410                         | 125                              | 8000 to 12000  | —                            | 250             | -27 to -63                | 10FP4-A  |
| 10½ Diam.   | Medium Cap            | D      | 7000  | 2000                   | 300                         | 125                              | 7000   | 1190 to 1790                 | 250             | -20 to -60                | 12AP4    |
| 11½ Diam.   | Small Cavity Cap      | E      | 12000   | —                      | 410                         | 125                              | 9000 to 12000  | —                            | 250             | -27 to -63                | 12KP4-A  |
| Ratings and characteristics are same as for type 12LP4-A. |                       |        |   |                        |                             |                                  |  |                              |                 |                           |          |
| 11 Diam.  | Small Cavity Cap      | E      | 12000   | —                      | 410                         | 125                              | 9000 to 12000  | —                            | 250             | -27 to -63                | 12LP4-A  |
| 11½ x 8½  | Small Cavity Cap      | E      | 14000   | —                      | 410                         | 125                              | 10000 to 14000   | —                            | 300             | -33 to -77                | 14CP4    |
| 11½ x 8½  | Small Cavity Cap      | E      | 14000   | —                      | 410                         | 125                              | 10000 to 14000   | —                            | 300             | -33 to -77                | 14EP4    |
| 11½ x 8½  | Small Cavity Cap      | H      | 14000   | +500<br>-500           | 500                         | 125                              | 12000<br>14000   | -50 to +265<br>-55 to +310   | 300             | -33 to -77                | 14HP4    |
| Ratings and characteristics are same as for type 16AP4-A. |                       |        |   |                        |                             |                                  |  |                              |                 |                           |          |
| 14½ Diam.   | Metal-Shell Lip       | F      | 14000   | —                      | 410                         | 125                              | 9000 to 14000  | —                            | 300             | -33 to -77                | 16AP4-A  |
| 14½ Diam.   | Small Cavity Cap      | F      | 15000   | —                      | 410                         | 125                              | 12000 to 15000   | —                            | 250             | -33 to -77                | 16DP4-A  |
| Ratings and characteristics are same as for type 16GP4-B. |                       |        |   |                        |                             |                                  |  |                              |                 |                           |          |
| Ratings and characteristics are same as for type 16GP4-B. |                       |        |   |                        |                             |                                  |  |                              |                 |                           |          |
| 14½ Diam.   | Metal-Shell Lip       | F      | 14000   | —                      | 410                         | 125                              | 12000 to 14000   | —                            | 300             | -33 to -77                | 16GP4-B  |
| Ratings and characteristics are same as for type 16GP4-B. |                       |        |   |                        |                             |                                  |  |                              |                 |                           |          |
| Ratings and characteristics are same as for type 16GP4-B. |                       |        |   |                        |                             |                                  |  |                              |                 |                           |          |
| 13½ x 10½   | Small Cavity Cap      | E      | 16000   | —                      | 410                         | 125                              | 12000 to 16000   | —                            | 500             | -33 to -77                | 16KP4    |
| 14½ Diam.   | Small Cavity Cap      | E      | 14000   | —                      | 410                         | 125                              | 12000 to 14000   | —                            | 300             | -33 to -77                | 16LP4-A  |
| 13½ x 10½   | Small Cavity Cap      | E      | 16000   | —                      | 410                         | 125                              | 12000 to 16000   | —                            | 300             | -33 to -77                | 16RP4    |
| 13½ x 10½   | Small Cavity Cap      | E      | 14000   | —                      | 410                         | 125                              | 12000 to 14000   | —                            | 300             | -33 to -77                | 16TP4    |
| 14½ Diam.   | Small Cavity Cap      | E      | 16000   | —                      | 410                         | 125                              | 12000 to 16000   | —                            | 250             | -27 to -63                | 16WP4-A  |
| 14½ x 10½   | Small Cavity Cap      | H      | 16000   | +1000<br>-500          | 500                         | 125                              | 14000<br>16000   | -55 to +310<br>-65 to +350   | 300             | -33 to -77                | 17AVP4   |
| 14½ x 10½   | Small Cavity Cap      | E      | 16000   | —                      | 410                         | 125                              | 12000 to 16000   | —                            | 300             | -33 to -77                | 17BP4-A  |
| 14½ x 10½   | Metal-Shell Lip       | F      | 16000   | —                      | 410                         | 125                              | 12000 to 16000   | —                            | 300             | -33 to -77                | 17CP4    |
| Ratings and characteristics are same as for type 17CP4-A. |                       |        |   |                        |                             |                                  |  |                              |                 |                           |          |
| 14½ x 10½   | Metal-Shell Lip       | G      | 16000   | 5000                   | 500                         | 125                              | 12000<br>14000   | 2040 to 2760<br>2380 to 3220 | 300             | -33 to -77                | 17OP4    |
| 14½ x 10½   | Small Cavity Cap      | H      | 16000   | +1000<br>-500*         | 500                         | 125                              | 14000<br>16000   | -55 to +300<br>-65 to +350   | 300             | -33 to -77                | 17HP4    |
| 14½ x 10½   | Small Cavity Cap      | E      | 18000   | —                      | 410                         | 125                              | 14000 to 18000   | —                            | 300             | -33 to -77                | 17JP4    |
| 14½ x 10½   | Small Cavity Cap      | H      | 16000   | +1000<br>-500*         | 500                         | 125                              | 14000<br>16000   | -55 to +300<br>-65 to +350   | 300             | -33 to -77                | 17LP4    |
| 14½ x 10½   | Small Cavity Cap      | J      | 16000   | —                      | 410                         | 125                              | 12000 to 16000   | —                            | 300             | -33 to -77                | 17QP4    |
| 14½ x 10½   | Metal-Shell Lip       | G      | 16000   | +1000<br>-500*         | 500                         | 125                              | 14000<br>16000   | -55 to +300<br>-65 to +350   | 300             | -33 to -77                | 17TP4    |
| Ratings and characteristics are same as for type 19AP4-B. |                       |        |   |                        |                             |                                  |  |                              |                 |                           |          |
| Ratings and characteristics are same as for type 19AP4-B. |                       |        |   |                        |                             |                                  |  |                              |                 |                           |          |
| 17½ Diam.   | Metal-Shell Lip       | F      | 19000   | —                      | 410                         | 125                              | 12000 to 19000   | —                            | 300             | -33 to -77                | 19AP4-A  |
| Ratings and characteristics are same as for type 19AP4-B. |                       |        |   |                        |                             |                                  |  |                              |                 |                           |          |
| Ratings and characteristics are same as for type 19AP4-B. |                       |        |   |                        |                             |                                  |  |                              |                 |                           |          |
| 17 x 12½  | Small Cavity Cap      | F      | 18000   | —                      | 410                         | 125                              | 14000 to 18000   | —                            | 300             | -33 to -77                | 20CP4    |
| 17 x 12½  | Small Cavity Cap      | H      | 16000   | +1000<br>-500*         | 500                         | 125                              | 14000<br>16000   | -55 to +300<br>-65 to +350   | 300             | -33 to -77                | 20MP4    |
| 19½ x 15  | Small Cavity Cap      | H      | 18000   | +1000<br>-500*         | 500                         | 125                              | 16000<br>18000   | -65 to +350<br>-75 to +400   | 300<br>400      | -33 to -77<br>-42 to -101 | 21ALP4-A |
| 18½ x 13½   | Metal-Shell Lip       | F      | 18000   | —                      | 410                         | 125                              | 14000 to 18000   | —                            | 300             | -33 to -77                | 21AP4    |
| Ratings and characteristics are same as for type 21EP4-A. |                       |        |   |                        |                             |                                  |  |                              |                 |                           |          |
| 19½ x 13½   | Small Cavity Cap      | J      | 18000   | —                      | 500                         | 125                              | 14000 to 18000   | —                            | 300             | -33 to -77                | 21EP4-A  |
| 19½ x 13½   | Small Cavity Cap      | H      | 18000   | +1000<br>-500*         | 500                         | 125                              | 14000<br>16000   | -55 to +300<br>-65 to +350   | 300             | -33 to -77                | 21FP4-A  |
| 18½ x 13½   | Metal-Shell Lip       | G      | 16000   | +1000<br>-500*         | 500                         | 125                              | 14000<br>16000   | -55 to +300<br>-65 to +350   | 300             | -33 to -77                | 21MP4    |
| 19½ x 14½   | Small Cavity Cap      | H      | 18000   | +1000<br>-500*         | 500                         | 125                              | 16000<br>18000   | -65 to +350<br>-70 to +395   | 300             | -28 to -72                | 21YP4    |
| Ratings and characteristics are same as for type 21YP4.   |                       |        |   |                        |                             |                                  |  |                              |                 |                           |          |
| 19½ x 14½   | Small Cavity Cap      | J      | 18000   | —                      | 500                         | 125                              | 16000 to 18000   | —                            | 300             | -28 to -72                | 21YP4-A  |
| Ratings and characteristics are same as for type 21ZP4-A. |                       |        |   |                        |                             |                                  |  |                              |                 |                           |          |
| 21½ x 16½   | Small Cavity Cap      | J      | 20000   | —                      | 500                         | 125                              | 16000 to 18000   | —                            | 300             | -28 to -72                | 21ZP4-A  |
| 23½ x 18½   | Metal-Shell Lip       | F      | 18000   | —                      | 500                         | 125                              | 16000 to 18000   | —                            | 300             | -33 to -77                | 27MP4    |
| <b>Color Types</b>  |                       |        |   |                        |                             |                                  |  |                              |                 |                           |          |
| 11½ x 8½  | Metal Flange          | K      | 20000   | 5000                   | 500                         | 200                              | For additional data, refer to technical bulletin available on request. |                              |                 |                           | 15GP22   |

## Notes for RCA Kinescope Characteristics Chart:

**E** = Electrostatic.

**M** = Magnetic.

Note: All kinescopes shown have 6.3-volt/0.6-ampere heaters except types 9AP4 and 12AP4 which have 2.5-volt/2.1-ampere heaters.

Light face = Discontinued type.

⊕ Spherical, unless otherwise specified.

‡ Utilizes metal-backed screen to prevent ion-spot blemish.

∞ Grid-No. 2 connected to final high-voltage electrode within tube.

• Corresponding diagonal deflection angle is 90°.

‡ For rectangular tubes, horizontal deflection angle is shown; corresponding diagonal deflection angle is 70° unless otherwise specified.

\* This value has been specified to take care of the condition where an ac voltage is provided for dynamic focusing.

\* At faceplate.

‡ Each gun.

■ Projection type.

▲▲ Cylindrical faceplate.

‡ Positive bias value = 0 volts; positive peak value = 2 volts.

# For visual extinction of undeflected focused spot. The values for visual extinction of focused raster are about 5 volts less negative than the indicated values.

\* ULTOR is defined as the electrode, or the electrode in combination with one or more additional electrodes connected within the tube to it, to which is applied the highest dc voltage for accelerating the electrons in the beam prior to its deflection.

○ Deflection Factors (volts dc/in.) for typical operating conditions shown:

| Type | Dj & Dj <sub>2</sub> (nearer screen) | Dj <sub>3</sub> & Dj <sub>4</sub> (nearer base) |
|------|--------------------------------------|---|
| 3KP4 | 100 to 136                           | 76 to 104                                       |
| 7JP4 | 186 to 246                           | 150 to 204                                      |

### Basing Diagrams for RCA Kinescopes:

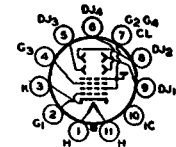

-A-  
ULTOR =  $G_2 + G_4 + CL$   
FOCUSING ELECTRODE =  $G_2$

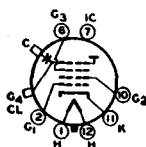

-B-  
ULTOR =  $G_4 + CL$   
FOCUSING ELECTRODE =  $G_2$

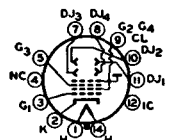

-C-  
ULTOR =  $G_2 + G_4 + CL$   
FOCUSING ELECTRODE =  $G_2$

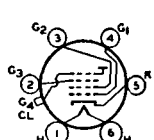

-D-  
ULTOR =  $G_4 + CL$   
FOCUSING ELECTRODE =  $G_2$

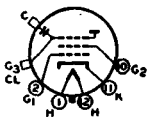

-E-  
ULTOR =  $G_2 + CL$

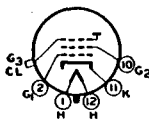

-F-  
ULTOR =  $G_2 + CL$

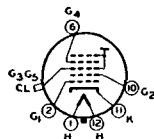

-G-  
ULTOR =  $G_2 + G_3 + CL$   
FOCUSING ELECTRODE =  $G_2$

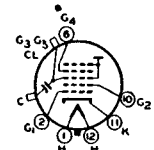

-H-  
ULTOR =  $G_2 + G_3 + CL$   
FOCUSING ELECTRODE =  $G_2$

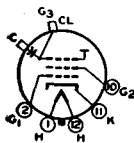

-J-  
ULTOR =  $G_2 + CL$

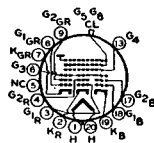

-K-  
ULTOR =  $G_5 + G_6 + CL$   
FOCUSING ELECTRODE =  $G_2$

## Spectral-Energy Emission Characteristics of Phosphors Used in RCA Kinescopes

SPECTRAL-ENERGY EMISSION CHARACTERISTIC OF PHOSPHOR P4 SULFIDE TYPE

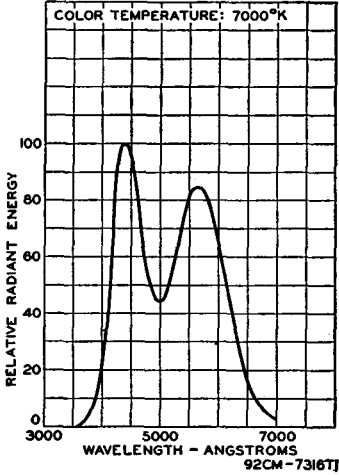

SPECTRAL-ENERGY EMISSION CHARACTERISTIC OF PHOSPHOR P4 SILICATE TYPE

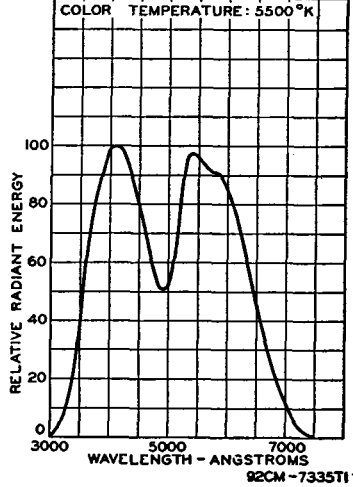

SPECTRAL-ENERGY EMISSION CHARACTERISTIC OF GROUP PHOSPHOR P22

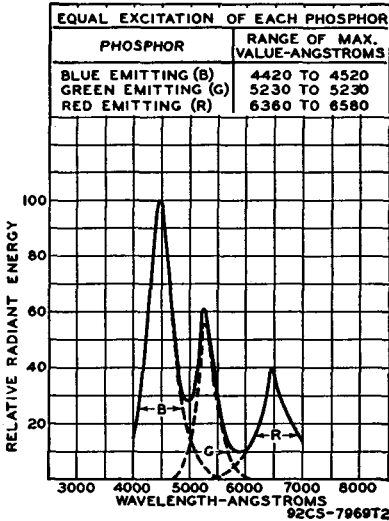

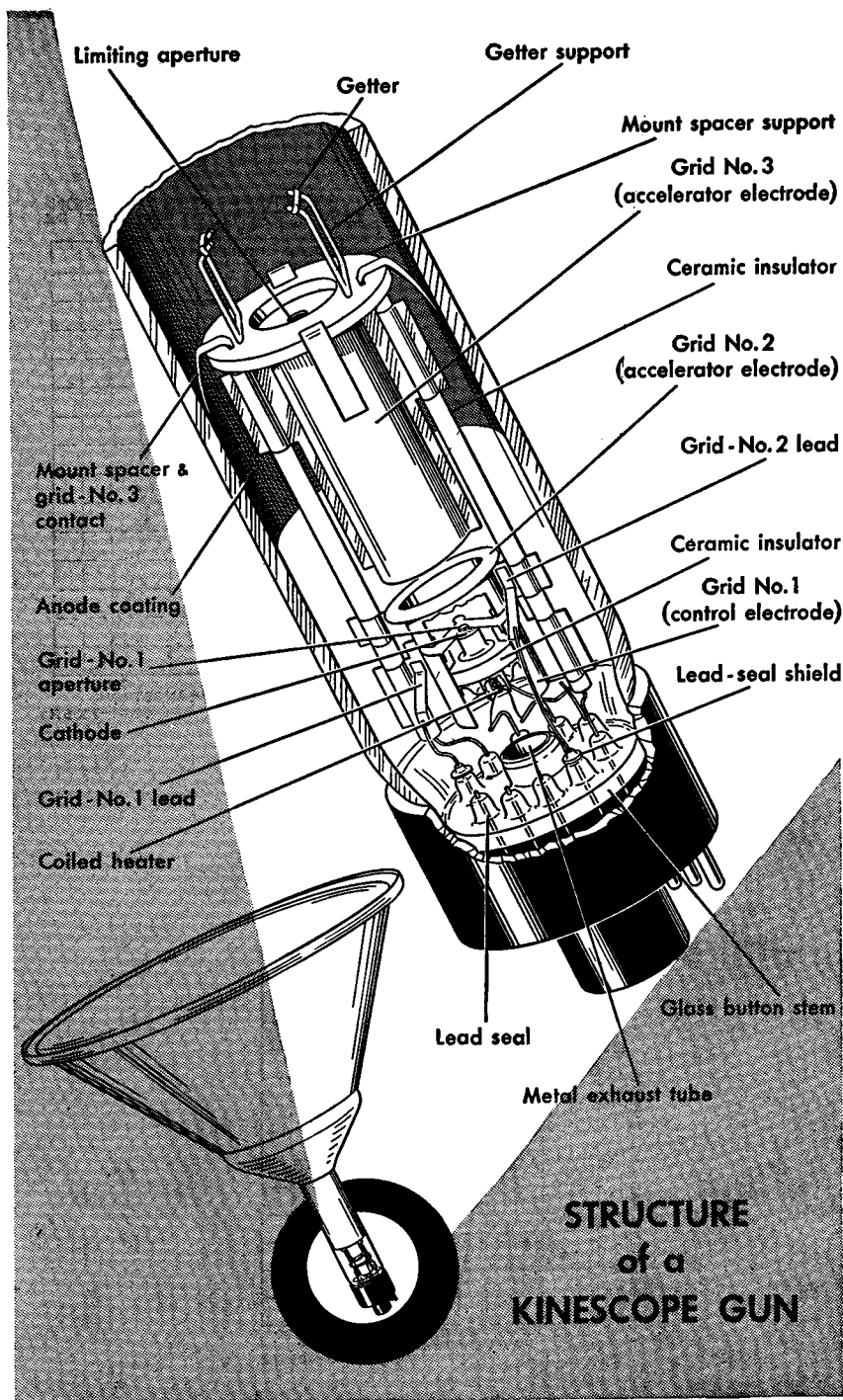

# Electron Tube Testing

The electron tube user—service man, experimenter, or non-technical radio listener—is interested in knowing the condition of his tubes, since they govern the performance of the device in which they are used. In order to determine the condition of a tube, some method of test is necessary. Because the operating capabilities and design features of a tube are indicated and described by its electrical characteristics, a tube is tested by measuring its characteristics and comparing them with values established as standard for that type. Tubes which read abnormally high with respect to the standard for the type are subject to criticism just the same as tubes which are too low.

Certain practical limitations are placed on the accuracy with which a tube test can be correlated with actual tube performance. These limitations make it impractical for the service man and dealer to employ complex and costly testing equipment having laboratory accuracy. Because the accuracy of the tube-testing device need be no greater than the accuracy of the correlation between test results and receiver performance, and since certain fundamental characteristics are virtually fixed by the manufacturing technique of leading tube manufacturers, it is possible to employ a relatively simple test in order to determine the serviceability of a tube.

In view of these factors, dealers and service men will find it economically expedient to obtain adequate accuracy and simplicity of operation by employing a device which indicates the status of a single characteristic. Whether the tube is satisfactory or unsatisfactory is judged from the test result of this single characteristic. Consequently, it is very desirable that the characteristic selected for the test be one which is truly representative of the tube's overall condition.

The following information and circuits are given to describe and illustrate general theoretical and practical tube-tester considerations and not to provide information on the construction of a home-made tube tester. In addition to the problem of determining what tube characteristic is most representative of performance capabilities in all types of receivers, the designer of a home-made tester faces the difficult problem of determining satisfactory limits for his particular tester. The obtaining of information of this nature, if it is to be accurate and useful, is a tremendous job. It requires the testing of a large number of tubes of each type, the testing of many types, and the correlation of these readings with performance in many kinds of equipment.

## SHORT CIRCUIT TEST

The fundamental circuit of a short-circuit tester is shown in Fig. 83. Although this circuit is suitable for tetrodes and types having less than four electrodes, tubes of more electrodes may be tested by adding more indicator lamps to the circuit. Voltages are applied between the various electrodes with lamps in series with the electrode leads. The value of the voltages applied will depend on the type of tube being tested. Any two shorted electrodes complete a circuit and light one or more lamps.

Since two electrodes may be just touching to give a high-resistance short, it is desirable that the indicating lamps operate on very low current. It is also desirable to maintain the filament or heater of the

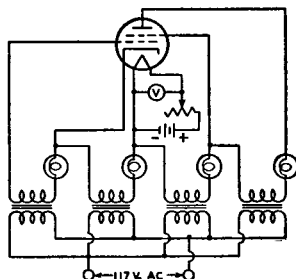

Fig. 83

tube at its operating temperature during the short-circuit test, because short-circuits in a tube may sometimes occur only when the electrodes are heated.

### SELECTION OF A SUITABLE CHARACTERISTIC FOR TEST

Some characteristics of a tube are far more important in determining its operating worth than are others. The cost of building a device to measure any one of the more important characteristics may be considerably higher than that of a device which measures a less representative characteristic. Consequently, three methods of test will be discussed, ranging from relatively simple and inexpensive equipment to more elaborate, more accurate, and more costly devices.

An emission test is perhaps the simplest method of indicating a tube's condition. (Refer to *Diodes*, in **ELECTRONS, ELECTRODES, AND ELECTRON TUBES SECTION**, for a discussion of electron emission.) Since emission falls off as the tube wears out, low emission is indicative of the end of tube serviceability. However, the emission test is subject to limitations because it tests the tube under static conditions and does not take into account the actual operation of the tube. On the one hand, coated filaments, or cathodes, often develop active spots from which the emission is so great that the relatively small grid area adjacent to these spots cannot control the electron stream. Under these conditions, the total emission may indicate the tube to be normal although the tube is unsatisfactory. On the other hand, coated types of filaments are capable of such large emission that the tube will often operate satisfactorily after the emission has fallen far below the original value.

Fig. 84 shows the fundamental circuit diagram for an emission test. All of the electrodes of the tube, except the cathode, are connected to the plate. The filament, or heater, is operated at rated voltage; after the tube has reached constant temperature, a low positive voltage is applied to the plate and the electron emission is read on the meter. Readings which are well below the average for a particular tube type indicate that the total number of available electrons has been so reduced that the tube is no longer able to function properly.

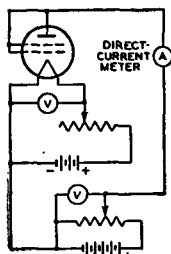

Fig. 84

A transconductance test takes into account a fundamental operating principle of the tube. (This will be seen from the definition of transconductance in the Section on **ELECTRON TUBE CHARACTERISTICS**.) It follows that transconductance tests when properly made, permit better correlation between test results and actual performance than does a straight emission test.

There are two forms of transconductance test which can be utilized in a tube tester. In the first form (illustrated by Fig. 85 giving a fundamental circuit with a tetrode under test), appropriate operating voltages are applied to the electrodes of the tube. A plate current depending upon the electrode voltages will then be indicated by the meter. If the bias on the grid is then shifted by the application of a different grid voltage, a new plate-current reading is obtained. The difference between the two plate-current readings is indicative of the transconductance of the tube. This method of transconductance testing is commonly called the "grid-shift" method, and depends on readings under static conditions. The fact that this form of test is made under static conditions imposes limitations not encountered in the second form of test made under dynamic conditions.

The dynamic transconductance test illustrated in Fig. 86 gives a fundamental circuit with a tetrode under test. This method is superior to the static transconductance test in that ac voltage is applied to the grid. Thus, the tube is tested

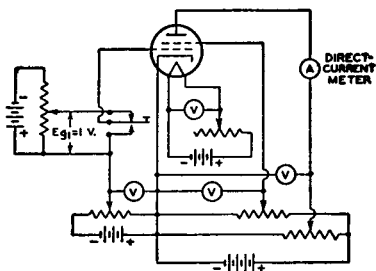

Fig. 85

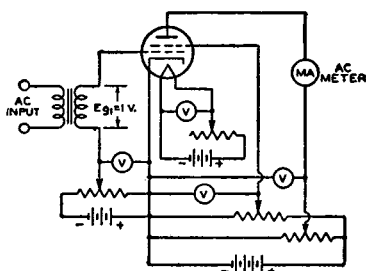

Fig. 86

under conditions which approximate actual operating conditions. The alternating component of the plate current is read by means of an acammeter of the dynamometer type. The transconductance of the tube is equal to the ac plate current divided by the input-signal voltage. If a one-volt rms signal is applied to the grid, the plate-current-meter reading in milliamperes multiplied by one thousand is the value of transconductance in micromhos.

The power-output test probably gives the best correlation between test results and actual operating performance of a tube. In the case of voltage amplifiers, the power output is indicative of the amplification and output voltages obtainable from the tube. In the case of power-output tubes, the performance of the tube is closely checked. Consequently, although more complicated to set up, the power-output test will give closer correlation with actual performance than any other single test.

Fig. 87 shows the fundamental circuit of a power-output test for class A operation of tubes. The diagram illustrates the method for a pentode. The ac output voltage developed across the plate-load impedance (L) is indicated by the current meter. The current meter is isolated as far as the dc plate current is concerned by the capacitor (C). The power output can be calculated from the current reading and known load resistance. In this way, it is possible to determine the operating condition of the tube quite accurately.

Fig. 88 shows the fundamental circuit of a power-output test for class B operation of tubes. With ac voltage applied to the grid of the tube, the current in the plate circuit is read on a dc milliammeter. The power output of the tube is approximately equal to:

$$\text{Power output (watts)} = \frac{(\text{dc current in amperes})^2 \times \text{load resistance in ohms}}{0.405}$$

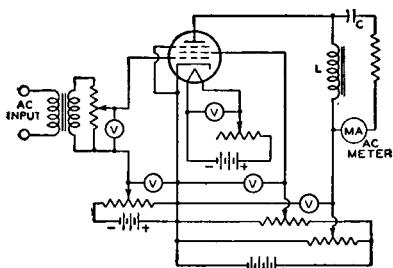

Fig. 87

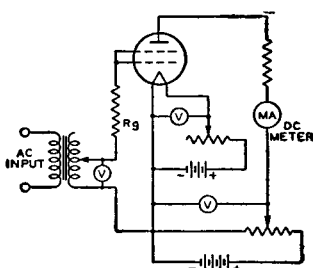

Fig. 88

### **ESSENTIAL TUBE-TESTER REQUIREMENTS**

1. It is desirable that the tester provide for a short-circuit test to be made prior to measurement of the tube's characteristics.

2. It is important that some means of controlling the voltages applied to the electrodes of the tube be provided. If the tester is ac operated, a line-voltage control permits the supply of proper electrode voltages.

3. It is essential that the rated voltage applied to the filament or heater be maintained accurately.

4. It is suggested that the characteristics test follow one of the methods described. The method selected and the quality of the parts used in the test will depend upon the requirements of the user.

### **TUBE-TESTER LIMITATIONS**

A tube-testing device can only indicate the difference between a given tube's characteristics and those which are standard for that particular type. Since the operating conditions imposed upon a tube of a given type may vary within wide limits, it is impossible for a tube-testing device to evaluate tubes in terms of performance capabilities for all applications. The tube tester, therefore, cannot be looked upon as a final authority in determining whether or not a tube is always satisfactory. Actual operating test in the equipment in which the tube is to be used will give the best possible indication of a tube's worth.



# Resistance-Coupled Amplifiers

| Type                    | Chart No. | Type                   | Chart No. |
|-------------------------|-----------|------------------------|-----------|
| 1L4                     | 1         | 6SJ7 (GT)              | 19        |
| 1S5                     | 2         | 6SL7-GT                | 7         |
| 1U4                     | 3         | 6SN7-GT (GTA)          | 13        |
| 1U5                     | 2         | 6SQ7 (GT)              | 4         |
| 6AQ6                    | 7         | 6SR7                   | 9         |
| 6AQ7-GT                 | 7         | 6ST7                   | 9         |
| 6AT6                    | 7         | 6SZ7                   | 7         |
| 6AU6                    | 8         | 6T8                    | 7         |
| 6AV6                    | 20        | 12AT6                  | 7         |
| 6B8                     | 5         | 12AU6                  | 8         |
| 6BF6                    | 9         | 12AU7                  | 10        |
| 6C4                     | 10        | 12AV6                  | 20        |
| 6C5 (GT)                | 11        | 12AX7                  | 20        |
| 6C6 } <sup>T</sup>      | 11        | 12C8                   | 5         |
| 6C6 } <sup>P</sup>      | 14        | 12J5-GT                | 13        |
| 6C8-G                   | 12        | 12J7-GT } <sup>T</sup> | 11        |
| 6F5 (GT)                | 17        | 12J7-GT } <sup>P</sup> | 14        |
| 6F8-G                   | 13        | 12Q7-GT                | 7         |
| 6J5 (GT)                | 13        | 12S8-GT                | 4         |
| 6J7 (GT) } <sup>T</sup> | 11        | 12SC7                  | 16        |
| 6J7 (GT) } <sup>P</sup> | 14        | 12SF5                  | 17        |
| 6N7 (GT)                | 6         | 12SF7                  | 18        |
| 6Q7 (GT)                | 7         | 12SH7                  | 8         |
| 6R7                     | 7         | 12SJ7                  | 19        |
|                         |           | 12SL7-GT               | 7         |
| 6S7                     | 15        | 12SN7-GT               | 13        |
| 6S8-GT                  | 4         | 12SQ7                  | 4         |
| 6SC7                    | 16        | 12SR7                  | 9         |
| 6SF5 (GT)               | 17        | 19T8                   | 7         |
| 6SF7                    | 18        | 53                     | 6         |
| 6SH7                    | 8         | 75                     | 4         |

T=Triode Connection  
P=Pentode Connection

## KEY TO CHARTS

Resistance-coupled, audio-frequency voltage amplifiers utilize simple components and are capable of providing essentially uniform amplification over a relatively wide frequency range.

### Suitable Tubes

In this section, data are given for over 50 types of tubes suitable for use in resistance-coupled circuits. These types include low- and high-mu triodes, twin triodes, triode-connected pentodes, and pentodes. The accompanying key to tube types will assist in locating the appropriate data chart.

### Circuit Advantages

For most of the types shown, the data pertain to operation with cathode bias; for all of the pentodes, the data pertain to operation with series screen resistor. The use of a cathode-bias resistor where feasible and a series screen resistor where applicable offer several advantages over fixed-voltage operation.

The advantages are: (1) effects of possible tube differences are minimized; (2) operation over a wide range of plate-supply voltages without appreciable change in gain is feasible; (3) the low frequency at which the amplifier cuts off is easily changed; and (4) tendency toward motorboating is minimized.

### Number of Stages

These advantages can be enhanced by the addition of suitable decoupling filters in the plate supply of each stage of a multi-stage amplifier. With proper filters, three or more amplifier stages can be operated from a single power-supply unit of conventional design without encountering any difficulties due to coupling through the power unit. When decoupling filters are not used, not more than two stages should be operated from a single power-supply unit.

**SYMBOLS USED IN RESISTANCE-COUPLED AMPLIFIER CHARTS**

- |  |  |
|--|--|
| <p><b>C</b> = Blocking Capacitor (<math>\mu</math>f).</p> <p><b>C<sub>k</sub></b> = Cathode Bypass Capacitor (<math>\mu</math>f).</p> <p><b>C<sub>g2</sub></b> = Screen Bypass Capacitor (<math>\mu</math>f).</p> <p><b>E<sub>bb</sub></b> = Plate-Supply Voltage (volts).<br/>Voltage at plate equals plate-supply voltage minus drop in R<sub>p</sub> and R<sub>k</sub>. See Note 1 below.</p> <p><b>R<sub>k</sub></b> = Cathode Resistor (ohms).</p> <p><b>R<sub>g2</sub></b> = Screen Resistor (megohms).</p> <p><b>R<sub>g</sub></b> = Grid Resistor (megohms) for following stage.</p> <p><b>R<sub>p</sub></b> = Plate Resistor (megohms).</p> | <p><b>V.G.</b> = Voltage Gain. At 5 volts (rms) output unless otherwise specified.</p> <p><b>E<sub>o</sub></b> = Peak Output Voltage (volts).<br/>This voltage is obtained across R<sub>g</sub> (for following stage) at any frequency within the flat region of the output vs frequency curve, and is for the condition where the signal level is adequate to swing the grid of the resistance-coupled amplifier tube to the point where its grid starts to draw current.</p> |
|--|--|

**Note 1:** For other supply voltages differing by as much as 50 per cent from those listed, the values of resistors, capacitors, and voltage gain are approximately correct. The value of voltage output, however, for any of these other supply voltages, equals the listed voltage output multiplied by the new plate-supply voltage divided by the plate-supply voltage corresponding to the listed voltage output.

**GENERAL CIRCUIT CONSIDERATIONS**

In the discussions which follow, the frequency ( $f_2$ ) is that value at which the high-frequency response begins to fall off. The frequency ( $f_1$ ) is that value at which the low-frequency response drops below a satisfactory value, as discussed below. Decoupling filters are not necessary for two stages or less. A variation of 10 per cent in values of resistors and capacitors has only slight effect on performance. One-half-watt resistors are usually suitable for R<sub>g2</sub>, R<sub>g</sub>, R<sub>p</sub>, and R<sub>k</sub> resistors. Capacitors C and C<sub>g2</sub> should have a working voltage equal to or greater than E<sub>bb</sub>. Capacitor C<sub>k</sub> may have a low working voltage in the order of 10 to 25 volts. Peak Input Voltage is equal to the Peak Output Voltage divided by the Voltage Gain.

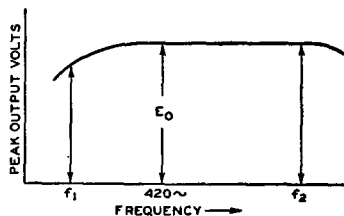

**Triode (Heater-Cathode Type) Amplifier**

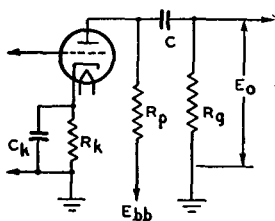

Diagram No. 1

Capacitors C and C<sub>k</sub> have been chosen to give an output voltage equal to 0.8 E<sub>o</sub> for a frequency ( $f_1$ ) of 100 cycles. For any other value of  $f_1$ , multiply values of C and C<sub>k</sub> by 100/ $f_1$ . In the case of capacitor C<sub>k</sub>, the values shown in the charts are for an amplifier with dc heater excitation; when ac is used, depending on the character of the associated circuit, the gain, and the value of  $f_1$ , it may be necessary to increase the value of C<sub>k</sub> to minimize hum disturbances. It may be desirable to operate the heater at a positive voltage of from 15 to 40 volts with respect to the cathode. The voltage output at  $f_1$  of "n" like stages equals  $(0.8)^n E_o$  where  $E_o$  is the peak output voltage of final stage. For an amplifier of typical construction, the value of  $f_2$  is well above the audio-frequency range for any value of R<sub>p</sub>.

### Pentode (Filament-Type) Amplifier

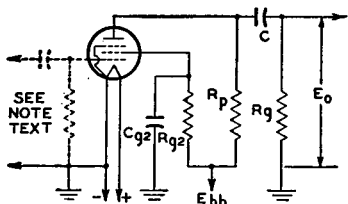

Diagram No. 2

should be such that their product lies between 0.02 and 0.1. Values commonly used are 0.005  $\mu$ f and 10 megohms.

Capacitors C and  $C_{g2}$  have been chosen to give an output voltage equal to  $0.8 E_o$  for a frequency ( $f_1$ ) of 100 cycles. For any other value of  $f_1$ , multiply values of C and  $C_{g2}$  by  $100/f_1$ . The voltage output at  $f_1$  for "n" like stages equals  $(0.8)^n E_o$  where  $E_o$  is peak output voltage of final stage. For an amplifier of typical construction, and for  $R_p$  values of 0.1, 0.25, and 0.5 megohm, approximate values of  $f_2$  are 20000, 10000, and 5000 cps, respectively. Note: The values of input-coupling capacitor in microfarads and of grid resistor in megohms

### Pentode (Heater-Cathode Type) Amplifier

Capacitors C,  $C_k$ , and  $C_{g2}$  have been chosen to give an output voltage equal to  $0.7 E_o$  for a frequency ( $f_1$ ) of 100 cycles. For any other value of  $f_1$ , multiply values of C,  $C_k$ , and  $C_{g2}$  by  $100/f_1$ . In the case of capacitor  $C_k$ , the values shown in the charts are for an amplifier with dc heater excitation; when ac is used, depending on the character of the associated circuits, the voltage gain, and the value of  $f_1$ , it may be necessary to increase the value of  $C_k$  to minimize hum disturbances. It may be desirable to operate the heater at a positive voltage of from 15 to 40 volts with respect to the cathode. The voltage output at  $f_1$  for "n" like stages equals  $(0.7)^n E_o$  where  $E_o$  is peak output voltage of final stage. For an amplifier of typical construction, and for  $R_p$  values of 0.1, 0.25, and 0.5 megohm, approximate values of  $f_2$  are 20000, 10000, and 5000 cps, respectively.

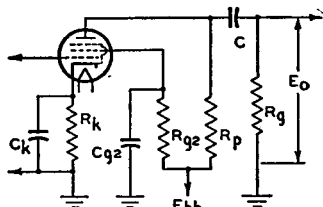

Diagram No. 3

### Phase Inverters

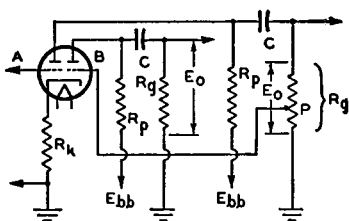

Diagram No. 4

values given in the charts. For example, if V.G. is 20 (from the charts), P is chosen so as to supply  $1/20$  of the voltage across  $R_g$  to the grid of unit B. For phase-inverter service, the cathode resistor may be left unbypassed unless a bypass capacitor is necessary to minimize hum; omission of the bypass capacitor assists in balancing the output stages. The value of  $R_k$  is specified on the basis that both units are operating simultaneously at the same values of plate load and plate voltage.

Information given for triode amplifiers, in general, applies to this case. Capacitors C have been chosen to give an output voltage equal to  $0.9 E_o$  for a frequency ( $f_1$ ) of 100 cycles. For any other value of  $f_1$ , multiply values of C by  $100/f_1$ . The signal input is applied to grid of triode unit A. Grid of triode unit B obtains its signal from a tap (P) on the grid resistor ( $R_g$ ) in the output circuit of unit A. The tap is chosen so as to make the voltage output of unit B equal to that of unit A. Its location is determined by the voltage gain

# RCA Receiving Tube Manual

(See page 256 for explanation of column headings)

1

**1L4**

See Circuit Diagram 2

| Ebb | R <sub>p</sub> | R <sub>g</sub> | R <sub>g2</sub> | R <sub>k</sub> | C <sub>g2</sub> | C <sub>k</sub> | C      | E <sub>o</sub> | V.G. |
|-----|----------------|----------------|-----------------|----------------|-----------------|----------------|--------|----------------|------|
| 45  | 0.22           | 0.22           | 0.24            | -              | 0.071           | -              | 0.011  | 12             | 16★  |
|     |                | 0.47           | 0.32            | -              | 0.06            | -              | 0.006  | 14             | 23   |
|     |                | 1.0            | 0.39            | -              | 0.056           | -              | 0.0035 | 18             | 30   |
|     | 0.47           | 0.47           | 0.57            | -              | 0.049           | -              | 0.0052 | 14             | 22   |
|     |                | 1.0            | 0.64            | -              | 0.047           | -              | 0.0035 | 17             | 30   |
|     |                | 2.2            | 0.74            | -              | 0.044           | -              | 0.0018 | 19             | 33   |
| 1.0 | 1.0            | 1.1            | -               | 0.036          | -               | 0.0028         | 14     | 28             |      |
|     | 2.2            | 1.25           | -               | 0.035          | -               | 0.0018         | 16     | 32             |      |
|     | 3.3            | 1.45           | -               | 0.032          | -               | 0.0015         | 18     | 38             |      |
| 90  | 0.22           | 0.22           | 0.4             | -              | 0.089           | -              | 0.011  | 26             | 28   |
|     |                | 0.47           | 0.46            | -              | 0.081           | -              | 0.0055 | 36             | 36   |
|     |                | 1.0            | 0.47            | -              | 0.08            | -              | 0.0035 | 42             | 41   |
|     | 0.47           | 0.47           | 0.84            | -              | 0.07            | -              | 0.0055 | 30             | 34   |
|     |                | 1.0            | 0.9             | -              | 0.069           | -              | 0.003  | 38             | 42   |
|     |                | 2.2            | 1.0             | -              | 0.062           | -              | 0.0018 | 40             | 50   |
| 1.0 | 1.0            | 2.0            | -               | 0.045          | -               | 0.0028         | 30     | 45             |      |
|     | 2.2            | 2.1            | -               | 0.045          | -               | 0.0018         | 35     | 55             |      |
|     | 3.3            | 2.2            | -               | 0.044          | -               | 0.0012         | 40     | 61             |      |
| 135 | 0.22           | 0.22           | 0.5             | -              | 0.09            | -              | 0.011  | 42             | 34   |
|     |                | 0.47           | 0.63            | -              | 0.074           | -              | 0.0055 | 54             | 51   |
|     |                | 1.0            | 0.67            | -              | 0.072           | -              | 0.0035 | 57             | 60   |
|     | 0.47           | 0.47           | 1.1             | -              | 0.071           | -              | 0.005  | 47             | 49   |
|     |                | 1.0            | 1.4             | -              | 0.06            | -              | 0.0028 | 54             | 68   |
|     |                | 2.2            | 1.5             | -              | 0.051           | -              | 0.0018 | 60             | 87   |
| 1.0 | 1.0            | 2.1            | -               | 0.059          | -               | 0.0025         | 45     | 53             |      |
|     | 2.2            | 2.4            | -               | 0.054          | -               | 0.0018         | 57     | 88             |      |
|     | 3.3            | 2.7            | -               | 0.049          | -               | 0.0012         | 61     | 91             |      |

2

**1S5  
1U5**

See Circuit Diagram 2

|     |      |      |      |       |       |        |        |    |    |
|-----|------|------|------|-------|-------|--------|--------|----|----|
| 45  | 0.22 | 0.22 | 0.26 | -     | 0.042 | -      | 0.013  | 14 | 17 |
|     |      | 0.47 | 0.36 | -     | 0.035 | -      | 0.006  | 17 | 24 |
|     |      | 1.0  | 0.4  | -     | 0.034 | -      | 0.004  | 18 | 28 |
|     | 0.47 | 0.47 | 0.82 | -     | 0.025 | -      | 0.0055 | 14 | 25 |
|     |      | 1.0  | 1.0  | -     | 0.023 | -      | 0.003  | 17 | 33 |
|     |      | 2.2  | 1.1  | -     | 0.022 | -      | 0.002  | 18 | 38 |
| 1.0 | 1.0  | 1.9  | -    | 0.019 | -     | 0.003  | 14     | 31 |    |
|     | 2.2  | 2.0  | -    | 0.019 | -     | 0.002  | 17     | 38 |    |
|     | 3.3  | 2.2  | -    | 0.018 | -     | 0.0015 | 18     | 43 |    |
| 90  | 0.22 | 0.22 | 0.5  | -     | 0.05  | -      | 0.011  | 31 | 25 |
|     |      | 0.47 | 0.59 | -     | 0.05  | -      | 0.006  | 37 | 34 |
|     |      | 1.0  | 0.67 | -     | 0.042 | -      | 0.003  | 40 | 41 |
|     | 0.47 | 0.47 | 1.2  | -     | 0.035 | -      | 0.005  | 31 | 37 |
|     |      | 1.0  | 1.4  | -     | 0.034 | -      | 0.003  | 36 | 47 |
|     |      | 2.2  | 1.6  | -     | 0.031 | -      | 0.002  | 40 | 57 |
| 1.0 | 1.0  | 2.5  | -    | 0.026 | -     | 0.003  | 31     | 45 |    |
|     | 2.2  | 2.9  | -    | 0.025 | -     | 0.002  | 36     | 58 |    |
|     | 3.3  | 3.1  | -    | 0.024 | -     | 0.0012 | 38     | 66 |    |
| 135 | 0.22 | 0.22 | 0.66 | -     | 0.052 | -      | 0.011  | 45 | 31 |
|     |      | 0.47 | 0.71 | -     | 0.051 | -      | 0.006  | 56 | 41 |
|     |      | 1.0  | 0.86 | -     | 0.039 | -      | 0.003  | 60 | 54 |
|     | 0.47 | 0.47 | 1.45 | -     | 0.042 | -      | 0.005  | 46 | 44 |
|     |      | 1.0  | 1.8  | -     | 0.034 | -      | 0.003  | 54 | 62 |
|     |      | 2.2  | 1.9  | -     | 0.033 | -      | 0.002  | 60 | 71 |
| 1.0 | 1.0  | 3.1  | -    | 0.03  | -     | 0.003  | 45     | 56 |    |
|     | 2.2  | 3.7  | -    | 0.029 | -     | 0.0015 | 53     | 76 |    |
|     | 3.3  | 4.3  | -    | 0.026 | -     | 0.0014 | 56     | 88 |    |

★ At 4 volts (rms) output.

# RCA Receiving Tube Manual

(See page 256 for explanation of column headings)

| E <sub>bb</sub> | R <sub>p</sub> | R <sub>g</sub> | R <sub>g2</sub> | R <sub>k</sub> | C <sub>g2</sub> | C <sub>k</sub> | C      | E <sub>o</sub> | V.G.            |
|-----------------|----------------|----------------|-----------------|----------------|-----------------|----------------|--------|----------------|-----------------|
| 45              | 0.22           | 0.22           | 0.06            | -              | 0.046           | -              | 0.011  | 11             | 23              |
|                 |                | 0.47           | 0.07            | -              | 0.045           | -              | 0.006  | 15             | 33              |
|                 |                | 1.0            | 0.011           | -              | 0.04            | -              | 0.003  | 17             | 39              |
|                 | 0.47           | 0.47           | 0.34            | -              | 0.025           | -              | 0.005  | 13             | 34              |
|                 |                | 1.0            | 0.44            | -              | 0.022           | -              | 0.003  | 16             | 46              |
|                 |                | 2.2            | 0.5             | -              | 0.022           | -              | 0.002  | 18             | 55              |
|                 | 1.0            | 1.0            | 1.0             | -              | 0.016           | -              | 0.003  | 14             | 43              |
|                 |                | 2.2            | 1.0             | -              | 0.016           | -              | 0.002  | 17             | 51              |
|                 |                | 3.3            | 1.1             | -              | 0.015           | -              | 0.001  | 17             | 60              |
| 90              | 0.22           | 0.22           | 0.3             | -              | 0.046           | -              | 0.01   | 27             | 37              |
|                 |                | 0.47           | 0.36            | -              | 0.04            | -              | 0.006  | 36             | 54              |
|                 |                | 1.0            | 0.4             | -              | 0.038           | -              | 0.003  | 39             | 63              |
|                 | 0.47           | 0.47           | 0.9             | -              | 0.027           | -              | 0.0045 | 29             | 61              |
|                 |                | 1.0            | 1.0             | -              | 0.023           | -              | 0.003  | 35             | 82              |
|                 |                | 2.2            | 1.1             | -              | 0.022           | -              | 0.002  | 38             | 96              |
|                 | 1.0            | 1.0            | 1.9             | -              | 0.02            | -              | 0.0025 | 30             | 77              |
|                 |                | 2.2            | 2.0             | -              | 0.02            | -              | 0.002  | 35             | 98              |
|                 |                | 3.3            | 2.2             | -              | 0.018           | -              | 0.001  | 37             | 114             |
| 135             | 0.22           | 0.22           | 0.4             | -              | 0.052           | -              | 0.011  | 44             | 46              |
|                 |                | 0.47           | 0.49            | -              | 0.037           | -              | 0.005  | 55             | 71              |
|                 |                | 1.0            | 0.52            | -              | 0.034           | -              | 0.003  | 60             | 83              |
|                 | 0.47           | 0.47           | 1.1             | -              | 0.029           | -              | 0.0045 | 45             | 77              |
|                 |                | 1.0            | 1.3             | -              | 0.023           | -              | 0.003  | 53             | 106             |
|                 |                | 2.2            | 1.4             | -              | 0.022           | -              | 0.002  | 59             | 123             |
|                 | 1.0            | 1.0            | 2.3             | -              | 0.021           | -              | 0.0025 | 45             | 104             |
|                 |                | 2.2            | 2.5             | -              | 0.019           | -              | 0.0015 | 53             | 136             |
|                 |                | 3.3            | 2.9             | -              | 0.016           | -              | 0.001  | 56             | 163             |
| 90              | 0.1            | 0.1            | -               | 6300           | -               | 2.2            | 0.02   | 3              | 23 <sup>●</sup> |
|                 |                | 0.25           | -               | 6600           | -               | 1.7            | 0.01   | 5              | 29 <sup>■</sup> |
|                 |                | 0.5            | -               | 6700           | -               | 1.7            | 0.006  | 6              | 31 <sup>★</sup> |
|                 | 0.25           | 0.25           | -               | 10000          | -               | 1.24           | 0.01   | 5              | 34 <sup>■</sup> |
|                 |                | 0.5            | -               | 11000          | -               | 1.07           | 0.006  | 7              | 40 <sup>★</sup> |
|                 |                | 1.0            | -               | 11500          | -               | 0.9            | 0.003  | 10             | 40              |
|                 | 0.5            | 0.5            | -               | 16200          | -               | 0.75           | 0.005  | 7              | 39              |
|                 |                | 1.0            | -               | 16600          | -               | 0.7            | 0.003  | 10             | 44              |
|                 |                | 2.0            | -               | 17400          | -               | 0.65           | 0.0015 | 13             | 48              |
| 180             | 0.1            | 0.1            | -               | 2600           | -               | 3.3            | 0.025  | 16             | 29              |
|                 |                | 0.25           | -               | 2900           | -               | 2.9            | 0.015  | 22             | 36              |
|                 |                | 0.5            | -               | 3000           | -               | 2.7            | 0.007  | 23             | 37              |
|                 | 0.25           | 0.25           | -               | 4300           | -               | 2.1            | 0.015  | 21             | 43              |
|                 |                | 0.5            | -               | 4800           | -               | 1.8            | 0.007  | 28             | 50              |
|                 |                | 1.0            | -               | 5300           | -               | 1.5            | 0.004  | 33             | 53              |
|                 | 0.5            | 0.5            | -               | 7000           | -               | 1.3            | 0.007  | 25             | 52              |
|                 |                | 1.0            | -               | 8000           | -               | 1.1            | 0.004  | 33             | 57              |
|                 |                | 2.0            | -               | 8800           | -               | 0.9            | 0.002  | 38             | 58              |
| 300             | 0.1            | 0.1            | -               | 1900           | -               | 4.0            | 0.03   | 31             | 31              |
|                 |                | 0.25           | -               | 2200           | -               | 3.5            | 0.015  | 41             | 39              |
|                 |                | 0.5            | -               | 2300           | -               | 3.0            | 0.007  | 45             | 42              |
|                 | 0.25           | 0.25           | -               | 3300           | -               | 2.7            | 0.015  | 42             | 48              |
|                 |                | 0.5            | -               | 3900           | -               | 2.0            | 0.007  | 51             | 53              |
|                 |                | 1.0            | -               | 4200           | -               | 1.8            | 0.004  | 60             | 56              |
|                 | 0.5            | 0.5            | -               | 5300           | -               | 1.6            | 0.007  | 47             | 58              |
|                 |                | 1.0            | -               | 6100           | -               | 1.3            | 0.004  | 62             | 60              |
|                 |                | 2.0            | -               | 7000           | -               | 1.2            | 0.002  | 67             | 63              |

3

1U4

See Circuit  
Diagram 2

4

6S8-GT  
6SQ7  
6SQ7-GT  
12SQ7  
12SQ7-GT  
75

See Circuit  
Diagram 1

● At 2 volts (rms) output. ■ At 3 volts (rms) output. ★ At 4 volts (rms) output.

# RCA Receiving Tube Manual

(See page 256 for explanation of column headings)

5

**6B8  
12C8**

See Circuit  
Diagram 3

| E <sub>bb</sub> | R <sub>p</sub> | R <sub>g</sub> | R <sub>g2</sub> | R <sub>k</sub> | C <sub>g2</sub> | C <sub>k</sub> | C      | E <sub>o</sub> | V.G. |
|-----------------|----------------|----------------|-----------------|----------------|-----------------|----------------|--------|----------------|------|
| 90              | 0.1            | 0.1            | 0.37            | 2000           | 0.07            | 3.0            | 0.02   | 19             | 24   |
|                 |                | 0.25           | 0.5             | 2200           | 0.07            | 3.0            | 0.01   | 28             | 33   |
|                 |                | 0.5            | 0.6             | 2000           | 0.06            | 2.8            | 0.006  | 29             | 37   |
|                 | 0.25           | 0.25           | 1.18            | 3500           | 0.04            | 1.9            | 0.008  | 26             | 43   |
|                 |                | 0.5            | 1.1             | 3500           | 0.04            | 2.1            | 0.007  | 33             | 55   |
|                 |                | 1.0            | 1.35            | 3500           | 0.04            | 1.9            | 0.003  | 32             | 65   |
|                 | 0.5            | 0.5            | 2.6             | 5000           | 0.04            | 1.5            | 0.004  | 22             | 63   |
|                 |                | 1.0            | 2.8             | 6000           | 0.04            | 1.55           | 0.003  | 29             | 85   |
|                 |                | 2.0            | 2.9             | 6200           | 0.04            | 1.5            | 0.003  | 27             | 100  |
| 180             | 0.1            | 0.1            | 0.44            | 1000           | 0.08            | 4.4            | 0.02   | 30             | 30   |
|                 |                | 0.25           | 0.5             | 1200           | 0.08            | 4.4            | 0.015  | 52             | 41   |
|                 |                | 0.5            | 0.6             | 1200           | 0.07            | 4.0            | 0.008  | 53             | 46   |
|                 | 0.25           | 0.25           | 1.18            | 1900           | 0.05            | 2.7            | 0.01   | 39             | 55   |
|                 |                | 0.5            | 1.2             | 2100           | 0.06            | 3.2            | 0.007  | 55             | 69   |
|                 |                | 1.0            | 1.5             | 2200           | 0.05            | 3.0            | 0.003  | 53             | 83   |
|                 | 0.5            | 0.5            | 2.6             | 3300           | 0.04            | 2.1            | 0.005  | 47             | 81   |
|                 |                | 1.0            | 2.8             | 3500           | 0.04            | 2.0            | 0.003  | 55             | 115  |
|                 |                | 2.0            | 3.0             | 3500           | 0.04            | 2.2            | 0.002  | 53             | 116  |
| 300             | 0.1            | 0.1            | 0.5             | 950            | 0.09            | 4.6            | 0.025  | 60             | 36   |
|                 |                | 0.25           | 0.55            | 1100           | 0.09            | 5.0            | 0.015  | 89             | 47   |
|                 |                | 0.5            | 0.6             | 900            | 0.08            | 4.8            | 0.009  | 86             | 54   |
|                 | 0.25           | 0.25           | 1.2             | 1500           | 0.06            | 3.2            | 0.015  | 70             | 64   |
|                 |                | 0.5            | 1.2             | 1600           | 0.06            | 3.5            | 0.008  | 100            | 79   |
|                 |                | 1.0            | 1.5             | 1800           | 0.08            | 4.0            | 0.004  | 95             | 100  |
|                 | 0.5            | 0.5            | 2.7             | 2400           | 0.05            | 2.5            | 0.006  | 80             | 96   |
|                 |                | 1.0            | 2.9             | 2500           | 0.05            | 2.3            | 0.003  | 120            | 150  |
|                 |                | 2.0            | 3.4             | 2800           | 0.05            | 2.8            | 0.0025 | 90             | 145  |

6

**6N7#  
6N7-GT#**

See Circuit  
Diagram 4

|     |      |      |   |       |   |   |        |     |    |
|-----|------|------|---|-------|---|---|--------|-----|----|
| 90  | 0.1  | 0.1  | - | 1900* | - | - | 0.025  | 13  | 16 |
|     |      | 0.25 | - | 2250* | - | - | 0.01   | 19  | 19 |
|     |      | 0.5  | - | 2500* | - | - | 0.006  | 20  | 20 |
|     | 0.25 | 0.25 | - | 4050* | - | - | 0.01   | 16  | 20 |
|     |      | 0.5  | - | 4950* | - | - | 0.006  | 20  | 22 |
|     |      | 1.0  | - | 5400* | - | - | 0.003  | 24  | 23 |
|     | 0.5  | 0.5  | - | 7000* | - | - | 0.006  | 18  | 22 |
|     |      | 1.0  | - | 8500* | - | - | 0.003  | 23  | 23 |
|     |      | 2.0  | - | 9650* | - | - | 0.0015 | 26  | 23 |
| 180 | 0.1  | 0.1  | - | 1300* | - | - | 0.03   | 35  | 19 |
|     |      | 0.25 | - | 1700* | - | - | 0.015  | 46  | 21 |
|     |      | 0.5  | - | 1950* | - | - | 0.007  | 50  | 22 |
|     | 0.25 | 0.25 | - | 2950* | - | - | 0.015  | 40  | 23 |
|     |      | 0.5  | - | 3800* | - | - | 0.007  | 50  | 24 |
|     |      | 1.0  | - | 4300* | - | - | 0.0035 | 57  | 24 |
|     | 0.5  | 0.5  | - | 5250* | - | - | 0.007  | 44  | 24 |
|     |      | 1.0  | - | 6600* | - | - | 0.0035 | 54  | 25 |
|     |      | 2.0  | - | 7650* | - | - | 0.002  | 61  | 25 |
| 300 | 0.1  | 0.1  | - | 1150* | - | - | 0.03   | 60  | 20 |
|     |      | 0.25 | - | 1500* | - | - | 0.015  | 83  | 22 |
|     |      | 0.5  | - | 1750* | - | - | 0.007  | 86  | 23 |
|     | 0.25 | 0.25 | - | 2650* | - | - | 0.015  | 75  | 23 |
|     |      | 0.5  | - | 3400* | - | - | 0.0055 | 87  | 24 |
|     |      | 1.0  | - | 4000* | - | - | 0.003  | 100 | 24 |
|     | 0.5  | 0.5  | - | 4850* | - | - | 0.0055 | 76  | 23 |
|     |      | 1.0  | - | 6100* | - | - | 0.003  | 94  | 24 |
|     |      | 2.0  | - | 7150* | - | - | 0.0015 | 104 | 24 |

# The cathodes of the two units have a common terminal  
\*Values shown are for phase-inverter service.

# RCA Receiving Tube Manual

(See page 256 for explanation of column headings)

| Ebb | R <sub>p</sub> | R <sub>g</sub> | R <sub>g2</sub> | R <sub>k</sub> | C <sub>g2</sub> | C <sub>k</sub> | C      | E <sub>o</sub> | V.G.            |
|-----|----------------|----------------|-----------------|----------------|-----------------|----------------|--------|----------------|-----------------|
| 90  | 0.1            | 0.1            | -               | 4200           | -               | 2.5            | 0.025  | 5.4            | 22 <sup>⊕</sup> |
|     |                | 0.22           | -               | 4600           | -               | 2.2            | 0.014  | 7.5            | 27 <sup>⊕</sup> |
|     |                | 0.47           | -               | 4800           | -               | 2.0            | 0.0065 | 9.1            | 30 <sup>⊕</sup> |
|     | 0.22           | 0.22           | -               | 7000           | -               | 1.5            | 0.013  | 7.3            | 30 <sup>⊕</sup> |
|     |                | 0.47           | -               | 7800           | -               | 1.3            | 0.007  | 10             | 34 <sup>⊕</sup> |
|     |                | 1.0            | -               | 8100           | -               | 1.1            | 0.0035 | 12             | 37 <sup>★</sup> |
|     | 0.47           | 0.47           | -               | 12000          | -               | 0.83           | 0.006  | 10             | 36 <sup>⊕</sup> |
|     |                | 1.0            | -               | 14000          | -               | 0.7            | 0.0035 | 14             | 39 <sup>★</sup> |
|     |                | 2.2            | -               | 15000          | -               | 0.6            | 0.002  | 16             | 41 <sup>★</sup> |
| 180 | 0.1            | 0.1            | -               | 1900           | -               | 3.6            | 0.027  | 19             | 30 <sup>★</sup> |
|     |                | 0.22           | -               | 2200           | -               | 3.1            | 0.014  | 25             | 35              |
|     |                | 0.47           | -               | 2500           | -               | 2.8            | 0.0065 | 32             | 37              |
|     | 0.22           | 0.22           | -               | 3400           | -               | 2.2            | 0.014  | 24             | 38              |
|     |                | 0.47           | -               | 4100           | -               | 1.7            | 0.0065 | 34             | 42              |
|     |                | 1.0            | -               | 4600           | -               | 1.5            | 0.0035 | 38             | 44              |
|     | 0.47           | 0.47           | -               | 6600           | -               | 1.1            | 0.0065 | 29             | 44              |
|     |                | 1.0            | -               | 8100           | -               | 0.9            | 0.0035 | 38             | 46              |
|     |                | 2.2            | -               | 9100           | -               | 0.8            | 0.002  | 43             | 47              |
| 300 | 0.1            | 0.1            | -               | 1500           | -               | 4.4            | 0.027  | 40             | 34              |
|     |                | 0.22           | -               | 1800           | -               | 3.6            | 0.014  | 54             | 38              |
|     |                | 0.47           | -               | 2100           | -               | 3.0            | 0.0065 | 63             | 41              |
|     | 0.22           | 0.22           | -               | 2600           | -               | 2.5            | 0.013  | 51             | 42              |
|     |                | 0.47           | -               | 3200           | -               | 1.9            | 0.0065 | 65             | 46              |
|     |                | 0.1            | -               | 3700           | -               | 1.6            | 0.0035 | 77             | 48              |
|     | 0.47           | 0.47           | -               | 5200           | -               | 1.2            | 0.006  | 61             | 48              |
|     |                | 1.0            | -               | 6300           | -               | 1.0            | 0.0035 | 74             | 50              |
|     |                | 2.2            | -               | 7200           | -               | 0.9            | 0.002  | 85             | 51              |

7

**6AQ6**  
**6AQ7-GT**  
**6AT6**  
**6Q7**  
**6Q7-GT**  
**6SL7-GT<sup>⊕</sup>**  
**6SZ7**  
**6T8**  
**12AT6**  
**12Q7-GT**  
**12SL7-GT<sup>⊕</sup>**  
**19T8**

See Circuit  
Diagram 1

|     |      |      |       |      |       |      |        |     |     |
|-----|------|------|-------|------|-------|------|--------|-----|-----|
| 90  | 0.1  | 0.1  | 0.07  | 1800 | 0.11  | 9.0  | 0.021  | 25  | 52  |
|     |      | 0.22 | 0.09  | 2100 | 0.1   | 8.2  | 0.012  | 32  | 72  |
|     |      | 0.47 | 0.096 | 2100 | 0.1   | 8.0  | 0.0065 | 37  | 88  |
|     | 0.22 | 0.22 | 0.25  | 3100 | 0.08  | 6.2  | 0.009  | 25  | 72  |
|     |      | 0.47 | 0.26  | 3200 | 0.078 | 5.8  | 0.0055 | 32  | 99  |
|     |      | 1.0  | 0.35  | 3700 | 0.085 | 5.1  | 0.003  | 34  | 125 |
|     | 0.47 | 0.47 | 0.75  | 6300 | 0.042 | 3.4  | 0.0035 | 27  | 102 |
|     |      | 1.0  | 0.75  | 6500 | 0.042 | 3.3  | 0.0027 | 32  | 126 |
|     |      | 2.2  | 0.8   | 6700 | 0.04  | 3.2  | 0.0018 | 36  | 152 |
| 180 | 0.1  | 0.1  | 0.12  | 800  | 0.15  | 14.1 | 0.021  | 57  | 74  |
|     |      | 0.22 | 0.15  | 900  | 0.126 | 14.0 | 0.012  | 82  | 116 |
|     |      | 0.47 | 0.19  | 1000 | 0.1   | 12.5 | 0.006  | 81  | 141 |
|     | 0.22 | 0.22 | 0.38  | 1500 | 0.09  | 9.6  | 0.009  | 59  | 130 |
|     |      | 0.47 | 0.43  | 1700 | 0.08  | 8.7  | 0.005  | 67  | 171 |
|     |      | 1.0  | 0.6   | 1900 | 0.066 | 8.1  | 0.003  | 71  | 200 |
|     | 0.47 | 0.47 | 0.9   | 3100 | 0.06  | 5.7  | 0.0045 | 54  | 172 |
|     |      | 1.0  | 1.0   | 3400 | 0.05  | 5.4  | 0.0028 | 65  | 232 |
|     |      | 2.2  | 1.1   | 3600 | 0.04  | 3.6  | 0.0019 | 74  | 272 |
| 300 | 0.1  | 0.1  | 0.2   | 500  | 0.13  | 18.0 | 0.019  | 76  | 109 |
|     |      | 0.22 | 0.24  | 600  | 0.11  | 16.4 | 0.011  | 103 | 145 |
|     |      | 0.47 | 0.26  | 700  | 0.11  | 15.3 | 0.006  | 129 | 168 |
|     | 0.22 | 0.22 | 0.42  | 1000 | 0.1   | 12.4 | 0.009  | 92  | 164 |
|     |      | 0.47 | 0.5   | 1000 | 0.098 | 12.0 | 0.007  | 108 | 230 |
|     |      | 1.0  | 0.55  | 1100 | 0.09  | 11.0 | 0.003  | 122 | 262 |
|     | 0.47 | 0.47 | 1.0   | 1800 | 0.075 | 8.0  | 0.0045 | 94  | 248 |
|     |      | 1.0  | 1.1   | 1900 | 0.065 | 7.6  | 0.0028 | 105 | 318 |
|     |      | 2.2  | 1.2   | 2100 | 0.06  | 7.3  | 0.0018 | 122 | 371 |

8

**6AU6**  
**6SH7**  
**12AU6**  
**12SH7**

See Circuit  
Diagram 3

⊕ - At 2 volts (rms) output. ■ At 3 volts (rms) output. ★ At 4 volts (rms) output.  
 ● One triode unit.

(See page 256 or explanation of column headings)

9

**6BF6  
6R7  
6SR7  
6ST7  
12SR7**

See Circuit Diagram 1

| Ebb | R <sub>p</sub> | R <sub>g</sub> | R <sub>g2</sub> | R <sub>k</sub> | C <sub>g2</sub> | C <sub>k</sub> | C      | E <sub>o</sub> | V.G. |
|-----|----------------|----------------|-----------------|----------------|-----------------|----------------|--------|----------------|------|
| 90  | 0.047          | 0.047          | -               | 2200           | -               | 2.5            | 0.063  | 14             | 9    |
|     |                | 0.1            | -               | 2800           | -               | 2.0            | 0.033  | 18             | 10   |
|     |                | 0.22           | -               | 3200           | -               | 1.7            | 0.015  | 20             | 10   |
|     | 0.1            | 0.1            | -               | 4100           | -               | 1.4            | 0.032  | 13             | 10   |
|     |                | 0.22           | -               | 5400           | -               | 1.0            | 0.013  | 20             | 11   |
|     |                | 0.47           | -               | 6400           | -               | 0.9            | 0.007  | 24             | 11   |
|     | 0.22           | 0.22           | -               | 8500           | -               | 0.67           | 0.015  | 18             | 11   |
|     |                | 0.47           | -               | 12000          | -               | 0.5            | 0.0065 | 23             | 11   |
|     |                | 1.0            | -               | 14000          | -               | 0.43           | 0.0035 | 27             | 11   |
| 180 | 0.047          | 0.047          | -               | 2000           | -               | 2.9            | 0.062  | 32             | 10   |
|     |                | 0.1            | -               | 2500           | -               | 2.2            | 0.033  | 42             | 10   |
|     |                | 0.22           | -               | 3000           | -               | 1.9            | 0.016  | 47             | 11   |
|     | 0.1            | 0.1            | -               | 3800           | -               | 1.5            | 0.033  | 36             | 11   |
|     |                | 0.22           | -               | 5100           | -               | 1.1            | 0.015  | 47             | 11   |
|     |                | 0.47           | -               | 6200           | -               | 0.9            | 0.007  | 55             | 12   |
|     | 0.22           | 0.22           | -               | 8000           | -               | 0.73           | 0.015  | 41             | 12   |
|     |                | 0.47           | -               | 11000          | -               | 0.5            | 0.007  | 54             | 12   |
|     |                | 1.0            | -               | 13000          | -               | 0.4            | 0.0035 | 69             | 12   |
| 300 | 0.047          | 0.047          | -               | 1800           | -               | 3.0            | 0.063  | 58             | 10   |
|     |                | 0.1            | -               | 2400           | -               | 2.4            | 0.033  | 74             | 11   |
|     |                | 0.22           | -               | 2900           | -               | 2.0            | 0.016  | 85             | 11   |
|     | 0.1            | 0.1            | -               | 3600           | -               | 1.6            | 0.033  | 65             | 12   |
|     |                | 0.22           | -               | 5000           | -               | 1.2            | 0.015  | 85             | 12   |
|     |                | 0.47           | -               | 6200           | -               | 0.95           | 0.007  | 96             | 12   |
|     | 0.22           | 0.22           | -               | 7800           | -               | 0.73           | 0.015  | 74             | 12   |
|     |                | 0.47           | -               | 11000          | -               | 0.5            | 0.007  | 95             | 12   |
|     |                | 1.0            | -               | 13000          | -               | 0.43           | 0.0035 | 106            | 12   |

10

**6C4  
12AU7\***

See Circuit Diagram 1

|     |       |       |   |       |   |      |        |    |                 |
|-----|-------|-------|---|-------|---|------|--------|----|-----------------|
| 90  | 0.047 | 0.047 | - | 1600  | - | 3.2  | 0.061  | 9  | 10 <sup>■</sup> |
|     |       | 0.1   | - | 1800  | - | 2.5  | 0.033  | 11 | 11 <sup>★</sup> |
|     |       | 0.22  | - | 2000  | - | 2.0  | 0.015  | 14 | 11              |
|     | 0.1   | 0.1   | - | 3000  | - | 1.6  | 0.032  | 10 | 11 <sup>★</sup> |
|     |       | 0.22  | - | 3800  | - | 1.1  | 0.015  | 15 | 11              |
|     |       | 0.47  | - | 4500  | - | 1.0  | 0.007  | 18 | 11              |
|     | 0.22  | 0.22  | - | 6800  | - | 0.7  | 0.015  | 14 | 11              |
|     |       | 0.47  | - | 9500  | - | 0.5  | 0.0065 | 20 | 11              |
|     |       | 1.0   | - | 11500 | - | 0.43 | 0.0035 | 24 | 11              |
| 180 | 0.047 | 0.047 | - | 920   | - | 3.9  | 0.062  | 20 | 11              |
|     |       | 0.1   | - | 1200  | - | 2.9  | 0.037  | 26 | 12              |
|     |       | 0.22  | - | 1400  | - | 2.5  | 0.016  | 29 | 12              |
|     | 0.1   | 0.1   | - | 2000  | - | 1.9  | 0.032  | 24 | 12              |
|     |       | 0.22  | - | 2800  | - | 1.4  | 0.016  | 33 | 12              |
|     |       | 0.47  | - | 3600  | - | 1.1  | 0.007  | 40 | 12              |
|     | 0.22  | 0.22  | - | 5300  | - | 0.8  | 0.015  | 31 | 12              |
|     |       | 0.47  | - | 8300  | - | 0.56 | 0.007  | 44 | 12              |
|     |       | 1.0   | - | 10000 | - | 0.48 | 0.0035 | 54 | 12              |
| 300 | 0.047 | 0.047 | - | 870   | - | 4.1  | 0.065  | 38 | 12              |
|     |       | 0.1   | - | 1200  | - | 3.0  | 0.034  | 52 | 12              |
|     |       | 0.22  | - | 1500  | - | 2.4  | 0.016  | 68 | 12              |
|     | 0.1   | 0.1   | - | 1900  | - | 1.9  | 0.032  | 44 | 12              |
|     |       | 0.22  | - | 3000  | - | 1.3  | 0.016  | 68 | 12              |
|     |       | 0.47  | - | 4000  | - | 1.1  | 0.007  | 80 | 12              |
|     | 0.22  | 0.22  | - | 5300  | - | 0.9  | 0.015  | 57 | 12              |
|     |       | 0.47  | - | 8800  | - | 0.52 | 0.007  | 82 | 12              |
|     |       | 1.0   | - | 11000 | - | 0.46 | 0.0035 | 92 | 12              |

■ At 3 volts (rms) output. ★ At 4 volts (rms) output. ● One triode unit.



# RCA Receiving Tube Manual

(See page 256 for explanation of column headings)

| Ebb  | R <sub>p</sub> | R <sub>g</sub> | R <sub>g2</sub> | R <sub>k</sub> | C <sub>g2</sub> | C <sub>k</sub> | C      | E <sub>o</sub> | V.G. |
|------|----------------|----------------|-----------------|----------------|-----------------|----------------|--------|----------------|------|
| 90   | 0.05           | 0.05           | -               | 2800           | -               | 2.0            | 0.05   | 14             | 9    |
|      |                | 0.1            | -               | 3400           | -               | 1.62           | 0.025  | 17             | 9    |
|      |                | 0.25           | -               | 3800           | -               | 1.3            | 0.01   | 20             | 10   |
|      | 0.1            | 0.1            | -               | 4800           | -               | 1.12           | 0.025  | 16             | 10   |
|      |                | 0.25           | -               | 6400           | -               | 0.84           | 0.01   | 22             | 11   |
|      |                | 0.5            | -               | 7500           | -               | 0.66           | 0.005  | 23             | 12   |
| 0.25 | 0.25           | -              | 11400           | -              | 0.52            | 0.01           | 18     | 12             |      |
|      | 0.5            | -              | 14500           | -              | 0.4             | 0.006          | 23     | 12             |      |
|      | 1.0            | -              | 17300           | -              | 0.33            | 0.004          | 26     | 13             |      |
| 180  | 0.05           | 0.05           | -               | 2200           | -               | 2.2            | 0.055  | 34             | 10   |
|      |                | 0.1            | -               | 2700           | -               | 2.1            | 0.03   | 45             | 11   |
|      |                | 0.25           | -               | 3100           | -               | 1.85           | 0.015  | 54             | 11   |
|      | 0.1            | 0.1            | -               | 3900           | -               | 1.7            | 0.035  | 41             | 12   |
|      |                | 0.25           | -               | 5300           | -               | 1.25           | 0.015  | 54             | 12   |
|      |                | 0.5            | -               | 6200           | -               | 1.2            | 0.008  | 55             | 13   |
|      | 0.25           | 0.25           | -               | 9500           | -               | 0.74           | 0.015  | 44             | 13   |
|      |                | 0.5            | -               | 12300          | -               | 0.55           | 0.008  | 52             | 13   |
|      |                | 1.0            | -               | 14700          | -               | 0.47           | 0.004  | 59             | 13   |
| 300  | 0.05           | 0.05           | -               | 2100           | -               | 3.16           | 0.075  | 57             | 11   |
|      |                | 0.1            | -               | 2600           | -               | 2.3            | 0.04   | 70             | 11   |
|      |                | 0.25           | -               | 3100           | -               | 2.2            | 0.015  | 83             | 12   |
|      | 0.1            | 0.1            | -               | 3800           | -               | 1.7            | 0.035  | 65             | 12   |
|      |                | 0.25           | -               | 5300           | -               | 1.3            | 0.015  | 84             | 13   |
|      |                | 0.5            | -               | 6000           | -               | 1.17           | 0.008  | 88             | 13   |
|      | 0.25           | 0.25           | -               | 9600           | -               | 0.9            | 0.015  | 73             | 13   |
|      |                | 0.5            | -               | 12300          | -               | 0.59           | 0.008  | 85             | 14   |
|      |                | 1.0            | -               | 14000          | -               | 0.37           | 0.003  | 97             | 14   |
| 90   | 0.1            | 0.1            | -               | 3040           | -               | 2.34           | 0.028  | 13             | 18   |
|      |                | 0.25           | -               | 3700           | -               | 1.48           | 0.0115 | 17             | 20   |
|      |                | 0.5            | -               | 4520           | -               | 1.29           | 0.006  | 19             | 21   |
|      | 0.25           | 0.25           | -               | 6770           | -               | 0.95           | 0.011  | 15             | 21   |
|      |                | 0.5            | -               | 7870           | -               | 0.81           | 0.0065 | 19             | 23   |
|      |                | 1.0            | -               | 8830           | -               | 0.69           | 0.0035 | 21             | 23   |
|      | 0.5            | 0.5            | -               | 12400          | -               | 0.51           | 0.006  | 16             | 22   |
|      |                | 1.0            | -               | 15000          | -               | 0.43           | 0.0035 | 20             | 24   |
|      |                | 2.0            | -               | 16500          | -               | 0.38           | 0.0015 | 25             | 24   |
| 180  | 0.1            | 0.1            | -               | 2420           | -               | 2.34           | 0.028  | 30             | 20   |
|      |                | 0.25           | -               | 3080           | -               | 1.84           | 0.012  | 40             | 22   |
|      |                | 0.5            | -               | 3560           | -               | 1.6            | 0.0065 | 45             | 23   |
|      | 0.25           | 0.25           | -               | 5170           | -               | 1.25           | 0.012  | 35             | 24   |
|      |                | 0.5            | -               | 6560           | -               | 0.95           | 0.007  | 45             | 25   |
|      |                | 1.0            | -               | 7550           | -               | 0.85           | 0.0035 | 50             | 26   |
|      | 0.5            | 0.5            | -               | 9840           | -               | 0.66           | 0.007  | 38             | 25   |
|      |                | 1.0            | -               | 12500          | -               | 0.5            | 0.004  | 44             | 26   |
|      |                | 2.0            | -               | 15600          | -               | 0.44           | 0.0015 | 51             | 26   |
| 300  | 0.1            | 0.1            | -               | 2120           | -               | 3.93           | 0.037  | 55             | 22   |
|      |                | 0.25           | -               | 2840           | -               | 2.01           | 0.013  | 73             | 23   |
|      |                | 0.5            | -               | 3250           | -               | 1.79           | 0.007  | 80             | 25   |
|      | 0.25           | 0.25           | -               | 4750           | -               | 1.29           | 0.013  | 64             | 25   |
|      |                | 0.5            | -               | 6100           | -               | 0.96           | 0.0065 | 80             | 26   |
|      |                | 1.0            | -               | 7100           | -               | 0.77           | 0.004  | 90             | 27   |
|      | 0.5            | 0.5            | -               | 9000           | -               | 0.67           | 0.007  | 67             | 27   |
|      |                | 1.0            | -               | 11500          | -               | 0.48           | 0.004  | 83             | 27   |
|      |                | 2.0            | -               | 14500          | -               | 0.37           | 0.002  | 96             | 28   |

11

**6C5  
6C5-GT**

As Triode:  
**6C6  
6J7  
6J7-GT  
6W7-G  
12J7-GT  
57**

See Circuit  
Diagram 1

12

**6C8-G\***

See Circuit  
Diagram 1

● One triode unit.

# RCA Receiving Tube Manual

(See page 256 for explanation of column headings)

| Ebb | R <sub>p</sub> | R <sub>g</sub> | R <sub>g2</sub> | R <sub>k</sub> | C <sub>g2</sub> | C <sub>k</sub> | C     | E <sub>o</sub> | V.G. |    |
|-----|----------------|----------------|-----------------|----------------|-----------------|----------------|-------|----------------|------|----|
| 13  | 90             | 0.047          | 0.047           | -              | 1870            | -              | 3.1   | 0.063          | 14   | 13 |
|     |                |                | 0.1             | -              | 2230            | -              | 2.5   | 0.031          | 18   | 14 |
|     |                |                | 0.22            | -              | 2500            | -              | 2.1   | 0.016          | 20   | 14 |
|     | 180            | 0.1            | 0.1             | -              | 3370            | -              | 1.8   | 0.034          | 15   | 14 |
|     |                |                | 0.22            | -              | 4100            | -              | 1.3   | 0.015          | 20   | 14 |
|     |                |                | 0.47            | -              | 4800            | -              | 1.1   | 0.006          | 23   | 15 |
|     |                | 0.22           | 0.22            | -              | 7000            | -              | 0.80  | 0.013          | 16   | 14 |
|     |                |                | 0.47            | -              | 9100            | -              | 0.65  | 0.007          | 22   | 14 |
|     |                |                | 1.00            | -              | 10500           | -              | 0.60  | 0.004          | 25   | 15 |
| 300 | 0.047          | 0.047          | -               | 1500           | -               | 3.6            | 0.066 | 33             | 14   |    |
|     |                | 0.1            | -               | 1860           | -               | 2.9            | 0.055 | 41             | 14   |    |
|     |                | 0.22           | -               | 2160           | -               | 2.2            | 0.015 | 47             | 15   |    |
|     | 180            | 0.1            | 0.1             | -              | 2750            | -              | 1.8   | 0.028          | 35   | 15 |
|     |                |                | 0.22            | -              | 3550            | -              | 1.4   | 0.015          | 45   | 15 |
|     |                |                | 0.47            | -              | 4140            | -              | 1.3   | 0.007          | 51   | 16 |
|     |                | 0.22           | 0.22            | -              | 5150            | -              | 1.0   | 0.016          | 36   | 16 |
|     |                |                | 0.47            | -              | 7000            | -              | 0.71  | 0.007          | 45   | 16 |
|     |                |                | 1.00            | -              | 7800            | -              | 0.61  | 0.004          | 51   | 16 |
| 300 | 0.047          | 0.047          | -               | 1300           | -               | 3.6            | 0.061 | 59             | 14   |    |
|     |                | 0.1            | -               | 1580           | -               | 3.0            | 0.032 | 73             | 15   |    |
|     |                | 0.22           | -               | 1800           | -               | 2.5            | 0.015 | 83             | 16   |    |
|     | 180            | 0.1            | 0.1             | -              | 2500            | -              | 1.9   | 0.031          | 68   | 16 |
|     |                |                | 0.22            | -              | 3130            | -              | 1.4   | 0.014          | 82   | 16 |
|     |                |                | 0.47            | -              | 3900            | -              | 1.2   | 0.0065         | 96   | 16 |
|     |                | 0.22           | 0.22            | -              | 4800            | -              | 0.95  | 0.015          | 68   | 16 |
|     |                |                | 0.47            | -              | 6500            | -              | 0.69  | 0.0065         | 85   | 16 |
|     |                |                | 1.00            | -              | 7800            | -              | 0.58  | 0.0035         | 96   | 16 |

See Circuit Diagram 1

|     |     |      |      |      |      |       |       |        |     |     |
|-----|-----|------|------|------|------|-------|-------|--------|-----|-----|
| 14  | 90  | 0.1  | 0.1  | 0.37 | 1200 | 0.05  | 5.2   | 0.02   | 17  | 41  |
|     |     |      | 0.25 | 0.44 | 1100 | 0.05  | 5.3   | 0.01   | 22  | 55  |
|     |     |      | 0.5  | 0.44 | 1300 | 0.05  | 4.8   | 0.006  | 33  | 66  |
|     | 180 | 0.25 | 0.25 | 1.1  | 2400 | 0.03  | 3.7   | 0.008  | 23  | 70  |
|     |     |      | 0.5  | 1.18 | 2600 | 0.03  | 3.2   | 0.005  | 32  | 85  |
|     |     |      | 1.0  | 1.4  | 3600 | 0.025 | 2.5   | 0.003  | 33  | 92  |
|     |     | 0.5  | 0.5  | 2.18 | 4700 | 0.02  | 2.3   | 0.005  | 28  | 93  |
|     |     |      | 1.0  | 2.6  | 5500 | 0.05  | 2.0   | 0.0025 | 29  | 120 |
|     |     |      | 2.0  | 2.7  | 5500 | 0.02  | 2.0   | 0.0015 | 27  | 140 |
| 300 | 0.1 | 0.1  | 0.44 | 1000 | 0.05 | 6.5   | 0.02  | 42     | 51  |     |
|     |     | 0.25 | 0.5  | 750  | 0.05 | 6.7   | 0.01  | 52     | 69  |     |
|     |     | 0.5  | 0.5  | 800  | 0.05 | 6.7   | 0.006 | 59     | 83  |     |
|     | 180 | 0.25 | 0.25 | 1.1  | 1200 | 0.04  | 5.2   | 0.008  | 41  | 93  |
|     |     |      | 0.5  | 1.18 | 1600 | 0.04  | 4.3   | 0.005  | 60  | 118 |
|     |     |      | 1.0  | 1.4  | 2000 | 0.04  | 3.8   | 0.0035 | 60  | 140 |
|     |     | 0.5  | 0.5  | 2.45 | 2600 | 0.03  | 3.2   | 0.005  | 45  | 135 |
|     |     |      | 1.0  | 2.9  | 3100 | 0.025 | 2.5   | 0.0025 | 56  | 165 |
|     |     |      | 2.0  | 2.7  | 3500 | 0.02  | 2.8   | 0.0015 | 60  | 165 |
| 300 | 0.1 | 0.1  | 0.44 | 500  | 0.07 | 8.5   | 0.02  | 55     | 61  |     |
|     |     | 0.25 | 0.5  | 450  | 0.07 | 8.3   | 0.01  | 81     | 82  |     |
|     |     | 0.5  | 0.53 | 600  | 0.06 | 8.0   | 0.006 | 96     | 94  |     |
|     | 180 | 0.25 | 0.25 | 1.18 | 1100 | 0.04  | 5.5   | 0.008  | 81  | 104 |
|     |     |      | 0.5  | 1.18 | 1200 | 0.04  | 5.4   | 0.005  | 104 | 140 |
|     |     |      | 1.0  | 1.45 | 1300 | 0.05  | 5.8   | 0.005  | 110 | 185 |
|     |     | 0.5  | 0.5  | 2.45 | 1700 | 0.04  | 4.2   | 0.005  | 75  | 161 |
|     |     |      | 1.0  | 2.9  | 2200 | 0.04  | 4.1   | 0.003  | 97  | 200 |
|     |     |      | 2.0  | 2.95 | 2300 | 0.04  | 4.0   | 0.0025 | 100 | 230 |

See Circuit Diagram 3

● One triode unit.

# RCA Receiving Tube Manual

(See page 256 for explanation of column headings)

| Ebb | R <sub>p</sub> | R <sub>g</sub> | R <sub>g2</sub> | R <sub>k</sub> | C <sub>g2</sub> | C <sub>k</sub> | C      | E <sub>o</sub> | V.G.*           |
|-----|----------------|----------------|-----------------|----------------|-----------------|----------------|--------|----------------|-----------------|
| 90  | 0.1            | 0.1            | 0.59            | 870            | 0.065           | 5.1            | 0.018  | 16             | 33              |
|     |                | 0.25           | 0.65            | 900            | 0.061           | 5.0            | 0.01   | 21             | 47              |
|     |                | 0.5            | 0.7             | 910            | 0.057           | 4.58           | 0.007  | 23             | 54              |
|     | 0.25           | 0.25           | 1.5             | 1440           | 0.044           | 3.38           | 0.007  | 14             | 56              |
|     |                | 0.5            | 1.6             | 1520           | 0.044           | 3.23           | 0.0055 | 18             | 66              |
|     |                | 1.0            | 1.7             | 1560           | 0.043           | 3.22           | 0.004  | 19             | 77              |
|     | 0.5            | 0.5            | 3.2             | 2620           | 0.029           | 2.04           | 0.004  | 12             | 70              |
|     |                | 1.0            | 3.5             | 2800           | 0.03            | 1.95           | 0.0026 | 15             | 84              |
|     |                | 2.0            | 3.7             | 3000           | 0.031           | 1.92           | 0.0024 | 16             | 94              |
| 180 | 0.1            | 0.1            | 0.58            | 530            | 0.073           | 7.2            | 0.017  | 33             | 47              |
|     |                | 0.25           | 0.68            | 540            | 0.07            | 6.9            | 0.01   | 43             | 66              |
|     |                | 0.5            | 0.71            | 540            | 0.065           | 6.6            | 0.0063 | 48             | 75              |
|     | 0.25           | 0.25           | 1.6             | 850            | 0.05            | 4.6            | 0.0071 | 33             | 79              |
|     |                | 0.5            | 1.8             | 890            | 0.044           | 4.7            | 0.005  | 40             | 104             |
|     |                | 1.0            | 1.9             | 950            | 0.046           | 4.4            | 0.0037 | 44             | 118             |
|     | 0.5            | 0.5            | 3.3             | 1410           | 0.041           | 3.5            | 0.0041 | 30             | 109             |
|     |                | 1.0            | 3.6             | 1520           | 0.037           | 3.0            | 0.003  | 38             | 134             |
|     |                | 2.0            | 3.8             | 1600           | 0.031           | 2.9            | 0.0024 | 42             | 147             |
| 300 | 0.1            | 0.1            | 0.59            | 430            | 0.007           | 8.5            | 0.0167 | 57             | 57              |
|     |                | 0.25           | 0.67            | 440            | 0.071           | 8.0            | 0.01   | 75             | 78              |
|     |                | 0.5            | 0.71            | 440            | 0.071           | 8.0            | 0.0066 | 82             | 89              |
|     | 0.25           | 0.25           | 1.7             | 620            | 0.058           | 6.0            | 0.0071 | 54             | 98              |
|     |                | 0.5            | 1.95            | 650            | 0.057           | 5.8            | 0.005  | 66             | 122             |
|     |                | 1.0            | 2.1             | 700            | 0.055           | 5.2            | 0.0036 | 76             | 136             |
|     | 0.5            | 0.5            | 3.6             | 1000           | 0.04            | 4.1            | 0.0037 | 52             | 136             |
|     |                | 1.0            | 3.9             | 1080           | 0.041           | 3.9            | 0.0029 | 66             | 162             |
|     |                | 2.0            | 4.1             | 1120           | 0.043           | 3.8            | 0.0023 | 73             | 174             |
| 90  | 0.1            | 0.1            | -               | 1850*          | -               | -              | 0.028  | 4.1            | 13 <sup>⊕</sup> |
|     |                | 0.25           | -               | 1960*          | -               | -              | 0.012  | 5.9            | 23 <sup>⊕</sup> |
|     |                | 0.5            | -               | 2050*          | -               | -              | 0.0065 | 6.9            | 25 <sup>★</sup> |
|     | 0.25           | 0.25           | -               | 3400*          | -               | -              | 0.011  | 6.2            | 26 <sup>★</sup> |
|     |                | 0.5            | -               | 3750*          | -               | -              | 0.006  | 8.6            | 30              |
|     |                | 1.0            | -               | 3900*          | -               | -              | 0.003  | 10             | 33              |
|     | 0.5            | 0.5            | -               | 5500*          | -               | -              | 0.005  | 7.4            | 31              |
|     |                | 1.0            | -               | 6300*          | -               | -              | 0.003  | 10             | 33              |
|     |                | 2.0            | -               | 7450*          | -               | -              | 0.0015 | 12             | 36              |
| 180 | 0.1            | 0.1            | -               | 960*           | -               | -              | 0.031  | 17             | 25              |
|     |                | 0.25           | -               | 1070*          | -               | -              | 0.012  | 24             | 29              |
|     |                | 0.5            | -               | 1220*          | -               | -              | 0.0065 | 27             | 33              |
|     | 0.25           | 0.25           | -               | 1850*          | -               | -              | 0.011  | 21             | 35              |
|     |                | 0.5            | -               | 2150*          | -               | -              | 0.006  | 28             | 39              |
|     |                | 1.0            | -               | 2400*          | -               | -              | 0.003  | 32             | 41              |
|     | 0.5            | 0.5            | -               | 3050*          | -               | -              | 0.006  | 24             | 40              |
|     |                | 1.0            | -               | 3420*          | -               | -              | 0.003  | 32             | 43              |
|     |                | 2.0            | -               | 3890*          | -               | -              | 0.002  | 36             | 45              |
| 300 | 0.1            | 0.1            | -               | 750*           | -               | -              | 0.033  | 35             | 29              |
|     |                | 0.25           | -               | 930*           | -               | -              | 0.014  | 50             | 34              |
|     |                | 0.25           | -               | 1040*          | -               | -              | 0.007  | 54             | 36              |
|     | 0.25           | 0.25           | -               | 1400*          | -               | -              | 0.012  | 45             | 39              |
|     |                | 0.5            | -               | 1680*          | -               | -              | 0.006  | 55             | 42              |
|     |                | 1.0            | -               | 1840*          | -               | -              | 0.003  | 64             | 45              |
|     | 0.5            | 0.5            | -               | 2330*          | -               | -              | 0.006  | 50             | 45              |
|     |                | 1.0            | -               | 2980*          | -               | -              | 0.003  | 62             | 48              |
|     |                | 2.0            | -               | 3280*          | -               | -              | 0.002  | 72             | 49              |

15

**6S7**

See Circuit Diagram 3

16

**6SC7<sup>#</sup>**  
**12SC7<sup>#</sup>**

See Circuit Diagram 4

⊕— At 2 volts (rms) output. ■ At 3 volts (rms) output. ★ At 4 volts (rms) output.  
# The cathodes of the two units have a common terminal.  
\* Values are for phase-inverter service.

# RCA Receiving Tube Manual

(See page 256 for explanation of column headings)

17

**6F5  
6F5-GT  
6SF5  
6SF5-GT  
12SF5**

See Circuit  
Diagram 1

| Ebb | R <sub>p</sub> | R <sub>g</sub> | R <sub>g2</sub> | R <sub>k</sub> | C <sub>g2</sub> | C <sub>k</sub> | C      | E <sub>o</sub> | V.G.            |
|-----|----------------|----------------|-----------------|----------------|-----------------|----------------|--------|----------------|-----------------|
| 90  | 0.1            | 0.1            | —               | 4400           | —               | 2.5            | 0.02   | 4              | 28 <sup>●</sup> |
|     |                | 0.25           | —               | 4800           | —               | 2.1            | 0.01   | 5              | 34 <sup>■</sup> |
|     |                | 0.5            | —               | 5000           | —               | 1.8            | 0.005  | 6              | 35 <sup>★</sup> |
|     | 0.25           | 0.25           | —               | 8000           | —               | 1.33           | 0.01   | 6              | 39 <sup>■</sup> |
|     |                | 0.5            | —               | 8800           | —               | 1.18           | 0.005  | 7              | 43 <sup>★</sup> |
|     |                | 1.0            | —               | 9000           | —               | 0.9            | 0.003  | 10             | 44              |
| 0.5 | 0.5            | —              | 12200           | —              | 0.76            | 0.005          | 8      | 43             |                 |
|     | 1.0            | —              | 13500           | —              | 0.67            | 0.003          | 10     | 46             |                 |
|     | 2.0            | —              | 14700           | —              | 0.58            | 0.0015         | 12     | 48             |                 |
| 180 | 0.1            | 0.1            | —               | 1800           | —               | 4.4            | 0.025  | 16             | 37              |
|     |                | 0.25           | —               | 2000           | —               | 3.3            | 0.015  | 23             | 44              |
|     |                | 0.5            | —               | 2200           | —               | 2.9            | 0.006  | 25             | 46              |
|     | 0.25           | 0.25           | —               | 3500           | —               | 2.3            | 0.01   | 21             | 48              |
|     |                | 0.5            | —               | 4100           | —               | 1.8            | 0.006  | 26             | 53              |
|     |                | 1.0            | —               | 4500           | —               | 1.7            | 0.004  | 32             | 57              |
|     | 0.5            | 0.5            | —               | 6100           | —               | 1.3            | 0.006  | 24             | 53              |
|     |                | 1.0            | —               | 6900           | —               | 0.9            | 0.003  | 33             | 63              |
|     |                | 2.0            | —               | 7700           | —               | 0.83           | 0.0015 | 37             | 66              |
| 300 | 0.1            | 0.1            | —               | 1300           | —               | 5.0            | 0.025  | 33             | 42              |
|     |                | 0.25           | —               | 1600           | —               | 3.7            | 0.01   | 43             | 49              |
|     |                | 0.5            | —               | 1700           | —               | 3.2            | 0.006  | 48             | 52              |
|     | 0.25           | 0.25           | —               | 2600           | —               | 2.5            | 0.01   | 41             | 56              |
|     |                | 0.5            | —               | 3200           | —               | 2.1            | 0.007  | 54             | 63              |
|     |                | 1.0            | —               | 3500           | —               | 2.0            | 0.004  | 63             | 67              |
|     | 0.5            | 0.5            | —               | 4500           | —               | 1.5            | 0.006  | 50             | 65              |
|     |                | 1.0            | —               | 5400           | —               | 1.2            | 0.004  | 62             | 70              |
|     |                | 2.0            | —               | 6100           | —               | 0.93           | 0.002  | 70             | 70              |

18

**6SF7  
12SF7**

See Circuit  
Diagram 3

|     |      |      |      |      |       |     |        |     |     |
|-----|------|------|------|------|-------|-----|--------|-----|-----|
| 90  | 0.1  | 0.1  | 0.26 | 1500 | 0.11  | 4.8 | 0.02   | 21  | 21  |
|     |      | 0.22 | 0.3  | 1600 | 0.1   | 4.4 | 0.012  | 26  | 29  |
|     |      | 0.47 | 0.35 | 1900 | 0.09  | 4.2 | 0.006  | 28  | 37  |
|     | 0.22 | 0.22 | 0.64 | 2400 | 0.09  | 3.4 | 0.009  | 21  | 33  |
|     |      | 0.47 | 0.7  | 2500 | 0.09  | 3.2 | 0.0055 | 26  | 40  |
|     |      | 1.0  | 0.84 | 2600 | 0.084 | 3.0 | 0.0035 | 29  | 52  |
|     | 0.47 | 0.47 | 1.5  | 4200 | 0.06  | 2.1 | 0.0045 | 21  | 50  |
|     |      | 1.0  | 1.6  | 4400 | 0.06  | 1.9 | 0.003  | 26  | 59  |
|     |      | 2.2  | 1.7  | 4800 | 0.058 | 1.6 | 0.002  | 29  | 64  |
| 180 | 0.1  | 0.1  | 0.33 | 1000 | 0.13  | 6.7 | 0.02   | 32  | 33  |
|     |      | 0.22 | 0.5  | 1200 | 0.12  | 5.8 | 0.011  | 37  | 45  |
|     |      | 0.47 | 0.6  | 1300 | 0.11  | 5.5 | 0.006  | 43  | 52  |
|     | 0.22 | 0.22 | 0.76 | 1700 | 0.11  | 4.5 | 0.0095 | 37  | 47  |
|     |      | 0.47 | 0.9  | 1700 | 0.1   | 4.5 | 0.0055 | 44  | 68  |
|     |      | 1.0  | 1.0  | 1800 | 0.1   | 4.2 | 0.003  | 47  | 82  |
|     | 0.47 | 0.47 | 1.8  | 3300 | 0.09  | 2.9 | 0.0045 | 38  | 70  |
|     |      | 1.0  | 2.0  | 3800 | 0.08  | 2.4 | 0.003  | 50  | 85  |
|     |      | 2.2  | 2.1  | 4000 | 0.07  | 2.3 | 0.002  | 57  | 98  |
| 300 | 0.1  | 0.1  | 0.32 | 750  | 0.19  | 8.0 | 0.021  | 62  | 39  |
|     |      | 0.22 | 0.36 | 850  | 0.18  | 7.7 | 0.012  | 80  | 46  |
|     |      | 0.47 | 0.37 | 900  | 0.18  | 7.7 | 0.006  | 93  | 57  |
|     | 0.22 | 0.22 | 0.8  | 1150 | 0.13  | 6   | 0.01   | 63  | 62  |
|     |      | 0.47 | 0.94 | 1300 | 0.12  | 5.7 | 0.0055 | 78  | 88  |
|     |      | 1.0  | 0.98 | 1500 | 0.11  | 5.0 | 0.0035 | 99  | 97  |
|     | 0.47 | 0.47 | 1.7  | 2300 | 0.1   | 3.5 | 0.0045 | 71  | 82  |
|     |      | 1.0  | 1.9  | 2500 | 0.1   | 3.5 | 0.003  | 89  | 109 |
|     |      | 2.2  | 2.0  | 2800 | 0.09  | 3.1 | 0.002  | 105 | 125 |

● At 2 volts (rms) output. ■ At 8 volts (rms) output. ★ At 4 volts (rms) output.

# RCA Receiving Tube Manual

(See page 256 for explanation of column headings)

| Ebb | R <sub>p</sub> | R <sub>g</sub> | R <sub>g2</sub> | R <sub>k</sub> | C <sub>g2</sub> | C <sub>k</sub> | C      | E <sub>o</sub> | V.G. |
|-----|----------------|----------------|-----------------|----------------|-----------------|----------------|--------|----------------|------|
| 90  | 0.1            | 0.1            | 0.29            | 820            | 0.09            | 8.8            | 0.02   | 18             | 41   |
|     |                | 0.25           | 0.29            | 880            | 0.085           | 7.4            | 0.016  | 23             | 68   |
|     |                | 0.5            | 0.31            | 1000           | 0.075           | 6.6            | 0.007  | 28             | 70   |
|     | 0.25           | 0.25           | 0.69            | 1680           | 0.06            | 5.0            | 0.012  | 16             | 75   |
|     |                | 0.5            | 0.92            | 1700           | 0.045           | 4.5            | 0.005  | 18             | 93   |
|     |                | 1.0            | 0.82            | 1800           | 0.04            | 4.0            | 0.003  | 22             | 104  |
|     | 0.5            | 0.5            | 1.5             | 3600           | 0.045           | 2.4            | 0.003  | 18             | 91   |
|     |                | 1.0            | 1.7             | 3800           | 0.03            | 2.4            | 0.002  | 22             | 119  |
|     |                | 2.0            | 1.9             | 4050           | 0.028           | 2.35           | 0.0015 | 24             | 139  |
| 180 | 0.1            | 0.1            | 0.29            | 760            | 0.10            | 9.1            | 0.019  | 49             | 55   |
|     |                | 0.25           | 0.31            | 800            | 0.09            | 8.0            | 0.015  | 60             | 82   |
|     |                | 0.5            | 0.37            | 860            | 0.09            | 7.8            | 0.007  | 62             | 91   |
|     | 0.25           | 0.25           | 0.83            | 1050           | 0.06            | 6.8            | 0.001  | 38             | 109  |
|     |                | 0.5            | 0.94            | 1060           | 0.06            | 6.6            | 0.004  | 47             | 131  |
|     |                | 1.0            | 0.94            | 1100           | 0.07            | 6.1            | 0.003  | 54             | 161  |
|     | 0.5            | 0.5            | 1.85            | 2000           | 0.05            | 4.0            | 0.003  | 37             | 151  |
|     |                | 1.0            | 2.2             | 2180           | 0.04            | 3.8            | 0.002  | 44             | 192  |
|     |                | 2.0            | 2.4             | 2410           | 0.035           | 3.6            | 0.0015 | 54             | 208  |
| 300 | 0.1            | 0.1            | 0.35            | 500            | 0.10            | 11.6           | 0.019  | 72             | 67   |
|     |                | 0.25           | 0.37            | 530            | 0.09            | 10.9           | 0.016  | 96             | 98   |
|     |                | 0.5            | 0.47            | 590            | 0.09            | 9.9            | 0.007  | 101            | 104  |
|     | 0.25           | 0.25           | 0.89            | 850            | 0.07            | 8.5            | 0.011  | 79             | 139  |
|     |                | 0.5            | 1.10            | 860            | 0.06            | 7.4            | 0.004  | 88             | 167  |
|     |                | 1.0            | 1.18            | 910            | 0.06            | 6.9            | 0.003  | 98             | 185  |
|     | 0.5            | 0.5            | 2.0             | 1300           | 0.06            | 6.0            | 0.004  | 64             | 200  |
|     |                | 1.0            | 2.2             | 1410           | 0.05            | 5.8            | 0.002  | 79             | 238  |
|     |                | 2.0            | 2.5             | 1530           | 0.04            | 5.2            | 0.0015 | 89             | 263  |
| 90  | 0.1            | 0.1            | -               | 4400           | -               | 2.7            | 0.023  | 5              | 29●  |
|     |                | 0.22           | -               | 4700           | -               | 2.4            | 0.013  | 6              | 35●  |
|     |                | 0.47           | -               | 4800           | -               | 2.3            | 0.007  | 8              | 41●  |
|     | 0.22           | 0.22           | -               | 7000           | -               | 1.6            | 0.001  | 6              | 39●  |
|     |                | 0.47           | -               | 7400           | -               | 1.4            | 0.006  | 9              | 45■  |
|     |                | 1.0            | -               | 7600           | -               | 1.3            | 0.003  | 11             | 48★  |
|     | 0.47           | 0.47           | -               | 12000          | -               | 0.9            | 0.006  | 9              | 48■  |
|     |                | 1.0            | -               | 13000          | -               | 0.8            | 0.003  | 11             | 52★  |
|     |                | 2.2            | -               | 14000          | -               | 0.7            | 0.002  | 13             | 55★  |
| 180 | 0.1            | 0.1            | -               | 1800           | -               | 4.0            | 0.025  | 18             | 40   |
|     |                | 0.22           | -               | 2000           | -               | 3.5            | 0.013  | 25             | 47   |
|     |                | 0.47           | -               | 2200           | -               | 3.1            | 0.006  | 32             | 52   |
|     | 0.22           | 0.22           | -               | 3000           | -               | 2.4            | 0.012  | 24             | 53   |
|     |                | 0.47           | -               | 3500           | -               | 2.1            | 0.006  | 34             | 59   |
|     |                | 1.0            | -               | 3900           | -               | 1.8            | 0.003  | 39             | 63   |
|     | 0.47           | 0.47           | -               | 5800           | -               | 1.3            | 0.006  | 30             | 62   |
|     |                | 1.0            | -               | 6700           | -               | 1.1            | 0.003  | 39             | 66   |
|     |                | 2.2            | -               | 7400           | -               | 1.0            | 0.002  | 45             | 68   |
| 300 | 0.1            | 0.1            | -               | 1300           | -               | 4.6            | 0.027  | 43             | 45   |
|     |                | 0.22           | -               | 1500           | -               | 4.0            | 0.013  | 57             | 52   |
|     |                | 0.47           | -               | 1700           | -               | 3.6            | 0.006  | 66             | 57   |
|     | 0.22           | 0.22           | -               | 2200           | -               | 3.0            | 0.013  | 54             | 59   |
|     |                | 0.47           | -               | 2800           | -               | 2.3            | 0.006  | 69             | 65   |
|     |                | 1.0            | -               | 3100           | -               | 2.1            | 0.003  | 79             | 68   |
|     | 0.47           | 0.47           | -               | 4300           | -               | 1.6            | 0.006  | 62             | 69   |
|     |                | 1.0            | -               | 5200           | -               | 1.3            | 0.003  | 77             | 73   |
|     |                | 2.2            | -               | 5900           | -               | 1.1            | 0.002  | 92             | 75   |

19

**6SJ7  
6SJ7-GT  
12SJ7**

See Circuit  
Diagram 3

20

**6AV6  
12AV6  
12AX7\***

See Circuit  
Diagram 1

● At 2 volts (rms) output. ■ At 3 volts (rms) output. ★ At 4 volts (rms) output.  
● One triode unit.

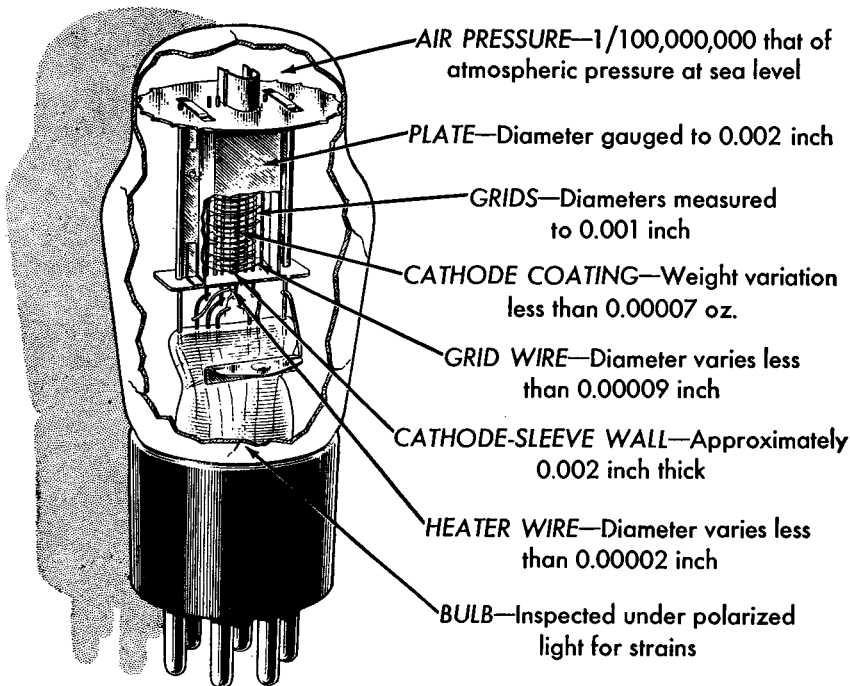

## Materials Used in RCA Electron Tubes

ACETIC ACID — ACETONE  
 ALUMINUM — ALUMINUM NITRATE — AMMONIUM CHLORIDE — AMMONIUM HYDROXIDE  
 AMYL ACETATE — ANTIMONY — ANTIMONY TRICHLORIDE — ARGON — BAKELITE — BARIUM  
 BARIUM CARBONATE — BARIUM NITRATE — BARIUM STRONTIUM TITANATE — BARIUM SULPHATE — BENTONITE — BENZENE — BERYLLIUM — BERYLLIUM OXIDE — BISMUTH — BORIC ACID — BORON — BUTYL ACETATE — BUTYL ALCOHOL — BUTYL CARBITOL — BUTYL CARBITOL ACETATE — CADMIUM — CESIUM — CESIUM CHROMATE — CALCIUM — CALCIUM CARBONATE — CALCIUM NITRATE — CALCIUM OXIDE — CAMPHOR — CARBON — CARBON BLACK — CARBON DIOXIDE — CARBON TETRACHLORIDE — CASTOR OIL — CHLORINE CHROMIC ACID — CHROMIUM — CLAY — COBALT — COPPER — DIACETONE ALCOHOL DIATOL — DIETHYL OXALATE — DISTILLED WATER — ETHER — ETHYL ALCOHOL — FERRIC OXIDE — FERRO TITANIUM — GLASS — GLYCERINE — GOLD — GRAPHITE — HELIUM GAS HYDROCHLORIC ACID — HYDROFLUORIC ACID — HYDROGEN GAS — HYDROGEN PEROXIDE — ILLUMINATING GAS — IRIIDIUM — IRON — ISOLANTITE — ISOPROPANOL — LAVA LEAD — LEAD BORATE — LEAD OXIDE — MAGNESIA — MAGNESIUM — MAGNESIUM NITRATE MALACHITE GREEN — MANGANESE — MARBLE DUST — MERCURY — METHANOL — MICA MISCH METAL — MOLYBDENUM — MONEL — NATURAL GAS — NEON — NICKEL — NICKEL CHLORIDE — NICKEL OXIDE — NICKEL SULPHATE — NITRIC ACID — NITROCELLULOSE NITROGEN — OXALIC ACID — OXYGEN — PALLADIUM — PALMITIC ACID — PETROLEUM JELLY — PHOSPHORIC ACID — PHOSPHORUS — PLATINUM — POTASSIUM — POTASSIUM CARBONATE — POTASSIUM FELDSPAR — POTASSIUM NITRATE — PORCELAIN — RADIUM RARE EARTHS — RESIN (synthetic) — ROSIN — RUBIDIUM — RUBIDIUM DICHLORATE — SHEL-LAC — SILICA — SILICON — SILVER — SILVER OXIDE — SODIUM — SODIUM CARBONATE STANNIC OXIDE — STEEL — STRONTIUM — STRONTIUM CARBONATE — STRONTIUM NITRATE SULPHUR — SULPHURIC ACID — TALC — TANTALUM — THALLIUM — THORIUM — THORIUM NITRATE — TIN — TITANIUM — TITANIUM DIOXIDE — TRICHLOROETHYLENE — TUNGSTEN WAX — WHEAT FLOUR — WOOD FIBER — XENON — ZINC — ZIRCONIUM HYDRIDE

# Circuits

The circuits presented in the following pages have been included in this Manual primarily to illustrate some of the more important applications of RCA receiving tubes and not necessarily as examples of commercial practice. These circuits have been conservatively designed and are capable of excellent performance. Electrical specifications are given for the circuit components to assist those interested in home construction. Layouts and mechanical details are omitted because they vary widely with the requirements of individual set builders and with the sizes and shapes of the components employed.

The results that may be expected by those undertaking construction of any of these circuits depend as much on the quality of the components selected and on the care employed in layout and construction as on the circuits themselves. Good signal reproduction from receivers and amplifiers requires the use of good-quality loudspeakers, transformers, chokes, and input sources (microphones, phonograph pickups, etc.). In addition, receivers—especially those of the superheterodyne type—require careful alignment.

Coils for the receiver circuits shown may be purchased at local parts dealers by specifying the characteristics required: for rf coils, the circuit position (antenna or interstage), tuning range desired, and tuning capacitance employed; for if coils or transformers, the intermediate frequency, circuit position (first if, second if, etc.), and, in some cases, the associated tube types; for oscillator coils, the receiver tuning range, intermediate frequency, type of converter tube, and type of winding (tapped or transformer-coupled).

The voltage ratings specified for capacitors are the minimum dc working voltages required. Where paper, mica, or ceramic capacitors are called for there is no objection to using capacitors of higher voltage ratings than those specified, except insofar as the physical sizes of such capacitors may affect equipment layout. However, if electrolytic capacitors having substantially higher voltage ratings than those specified are used, they may not "form" completely at the voltages present in these circuits, with the result that the effective capacitances of such units may be below their rated values. The wattage ratings specified for resistors assume methods of construction that provide adequate ventilation; compact installations having poor ventilation may require resistors of higher wattage ratings.

Information on the characteristics and application features of each tube will be found in the TUBE TYPES SECTION. This information will prove of assistance in understanding and utilizing the circuits.

The following circuits will be found in the subsequent pages:

|  | <i>Circuit No.</i> |
|--|--------------------|
| Portable Battery-Operated Superheterodyne Receiver . . . . .                 | 17-1               |
| Portable 3-Way Superheterodyne Receiver . . . . .                            | 17-2               |
| AC-Operated Superheterodyne Receiver . . . . .                               | 17-3               |
| AC/DC Superheterodyne Receiver . . . . .                                     | 17-4               |
| Automobile Receiver . . . . .  | 17-5               |
| Superregenerative Receiver . . . . .   | 17-6               |
| Battery-Operated Short-Wave Receiver . . . . .                               | 17-7               |
| TRF AM Tuner for High-Fidelity Local Broadcast Reception . . . . .           | 17-8               |
| FM Tuner . . . . .   | 17-9               |
| Microphone and Phonograph Amplifier (6 watts) . . . . .                      | 17-10              |
| High-Fidelity Audio Amplifier, Class AB <sub>1</sub> (10 watts) . . . . .    | 17-11              |
| High-Power Audio Amplifier, Class AB <sub>1</sub> (25 watts) . . . . .       | 17-12              |
| Class B Amplifier for Mobile Use (10 watts) . . . . .                        | 17-13              |
| Two-Channel Audio Mixer . . . . .  | 17-14              |
| Preamplifier for Magnetic Phonograph Pickup . . . . .                        | 17-15              |
| Low-Distortion Input Stage . . . . .   | 17-16              |
| Two-Stage Input Amplifier, Cathode-Follower (Low-Impedance) Output . . . . . | 17-17              |
| Bass and Treble Tone-Control Amplifier Stage . . . . .                       | 17-18              |
| Non-Motorboating Resistance-Coupled Amplifier . . . . .                      | 17-19              |
| Code-Practice Oscillator . . . . .   | 17-20              |
| Intercommunication Set . . . . .   | 17-21              |
| Electronic Volt-Ohm Meter . . . . .  | 17-22              |

(17-1)

## PORTABLE BATTERY-OPERATED SUPERHETERODYNE RECEIVER

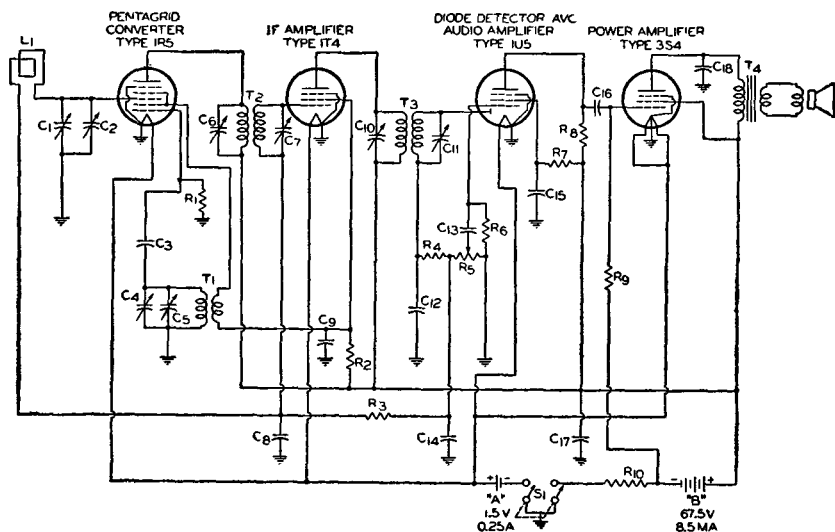

$C_1 C_4$  = Ganged tuning capacitors:  $C_1$ , 10-274  $\mu\text{f}$ ;  $C_4$ , 7.5-122.5  $\mu\text{f}$   
 $C_2 C_5$  = Trimmer capacitors, 2-15  $\mu\text{f}$   
 $C_3$  = 56  $\mu\text{f}$ , ceramic  
 $C_6 C_7 C_{10} C_{11}$  = Trimmer capacitors for if transformers  
 $C_8$  = 0.05  $\mu\text{f}$ , paper, 50 v.  
 $C_9 C_{15}$  = 0.02  $\mu\text{f}$ , paper, 100 v.  
 $C_{12}$  = 82  $\mu\text{f}$ , ceramic  
 $C_{13} C_{16}$  = 0.002  $\mu\text{f}$ , paper, 150 v.  
 $C_{14}$  = 33  $\mu\text{f}$ , ceramic

$C_{17}$  = 10  $\mu\text{f}$ , electrolytic, 100 v.  
 $C_{18}$  = 0.005  $\mu\text{f}$ , paper, 600 v.  
 $L_1$  = Loop antenna, 540-1600 Kc  
 $R_1$  = 100000 ohms, 0.25 watt  
 $R_2$  = 150000 ohms, 0.25 watt  
 $R_3 R_6$  = 3.3 megohms, 0.25 watt  
 $R_4$  = 68000 ohms, 0.25 watt  
 $R_5$  = Volume control, potentiometer, 2 megohms  
 $R_8$  = 10 megohms, 0.25 watt  
 $R_7$  = 4.7 megohms, 0.25 watt  
 $R_9$  = 1 megohm, 0.25 watt

$R_{10}$  = 820 ohms, 0.25 watt  
 $S_1$  = Switch, double-pole, single-throw  
 $T_1$  = Oscillator coil for use with tuning capacitor of 7.5-122.5  $\mu\text{f}$ , and 455 Kc if transformer  
 $T_2 T_3$  = Intermediate-frequency transformers, 455 Kc  
 $T_4$  = Output transformer for matching impedance of voice coil to 5000-ohm tube load



(17-2)

PORTABLE 3-WAY SUPERHETERODYNE RECEIVER

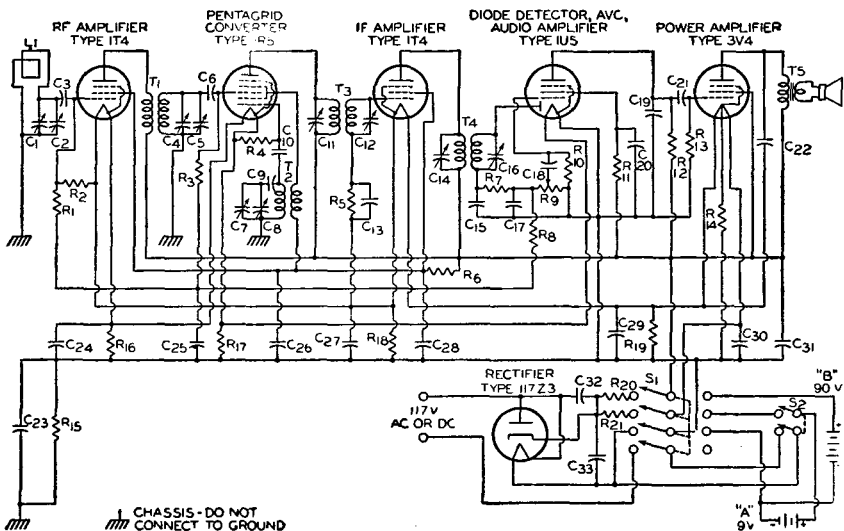

- C<sub>1</sub> C<sub>4</sub> C<sub>8</sub> = Ganged tuning capacitors, 20-450 μf
- C<sub>2</sub> C<sub>3</sub> C<sub>7</sub> = Trimmer capacitors, 4-30 μf
- C<sub>9</sub> C<sub>10</sub> C<sub>15</sub> C<sub>17</sub> = 100 μf, ceramic
- C<sub>6</sub> = 82 μf, ceramic
- C<sub>9</sub> = 560 μf, ceramic
- C<sub>11</sub> C<sub>12</sub> C<sub>14</sub> C<sub>18</sub> = Trimmer capacitors for if transformers
- C<sub>12</sub> = 0.01 μf, paper 400 v.
- C<sub>18</sub> C<sub>21</sub> = 0.002 μf, paper, 400 v.
- C<sub>19</sub> = 270 μf, ceramic
- C<sub>20</sub> = 0.02 μf, paper, 400 v.
- C<sub>22</sub> C<sub>32</sub> = 0.005 μf, paper, 400 v.
- C<sub>23</sub> = 0.1 μf, paper, 400 v.
- C<sub>24</sub> = 0.05 μf, paper, 200 v.
- C<sub>25</sub> = 0.05 μf, paper, 50 v.
- C<sub>26</sub> C<sub>27</sub> C<sub>28</sub> = 0.05 μf, paper, 400 v.
- C<sub>29</sub> = 40 μf, electrolytic, 25 v.

- C<sub>30</sub> = 160 μf, electrolytic, 25 v.
- C<sub>31</sub> C<sub>33</sub> = 20 μf, electrolytic, 150 v.
- L<sub>1</sub> = Loop antenna, 540-1600 Kc
- R<sub>1</sub> R<sub>2</sub> R<sub>11</sub> = 4.7 megohms, 0.25 watt
- R<sub>3</sub> = 2.2 megohms, 0.25 watt
- R<sub>4</sub> = 100000 ohms, 0.25 watt
- R<sub>5</sub> = 5.6 megohms, 0.25 watt
- R<sub>6</sub> = 27000 ohms, 0.25 watt
- R<sub>7</sub> = 68000 ohms, 0.25 watt
- R<sub>8</sub> = 3.3 megohms, 0.25 watt
- R<sub>9</sub> = Volume control, potentiometer, 1 megohm
- R<sub>10</sub> = 10 megohms, 0.25 watt
- R<sub>12</sub> = 220000 ohms, 0.25 watt
- R<sub>13</sub> = 1 megohm, 0.25 watt
- R<sub>14</sub> R<sub>16</sub> = 1800 ohms, 0.25 watt
- R<sub>15</sub> = 220000 ohms, 0.5 watt
- R<sub>17</sub> = 1000 ohms, 0.25 watt

- R<sub>18</sub> = 2700 ohms, 0.25 watt
- R<sub>19</sub> = 1500 ohms, 0.25 watt
- R<sub>20</sub> = 1800 ohms, 10 watts
- R<sub>21</sub> = 2300 ohms, 10 watts
- S<sub>1</sub> = Switch, 4-pole double-throw
- S<sub>2</sub> = Switch, double-pole, single-throw
- T<sub>1</sub> = RF transformer, 540-1600 Kc
- T<sub>2</sub> = Oscillator coil for use with a 560-μf padder, 20-450 μf tuning capacitor, and 455 Kc if transformer
- T<sub>3</sub> T<sub>4</sub> = Intermediate-frequency transformers, 455 Kc
- T<sub>5</sub> = Output transformer for matching impedance of voice coil to 10000-ohm tube load

(17-3)

**AC-OPERATED SUPERHETERODYNE RECEIVER**

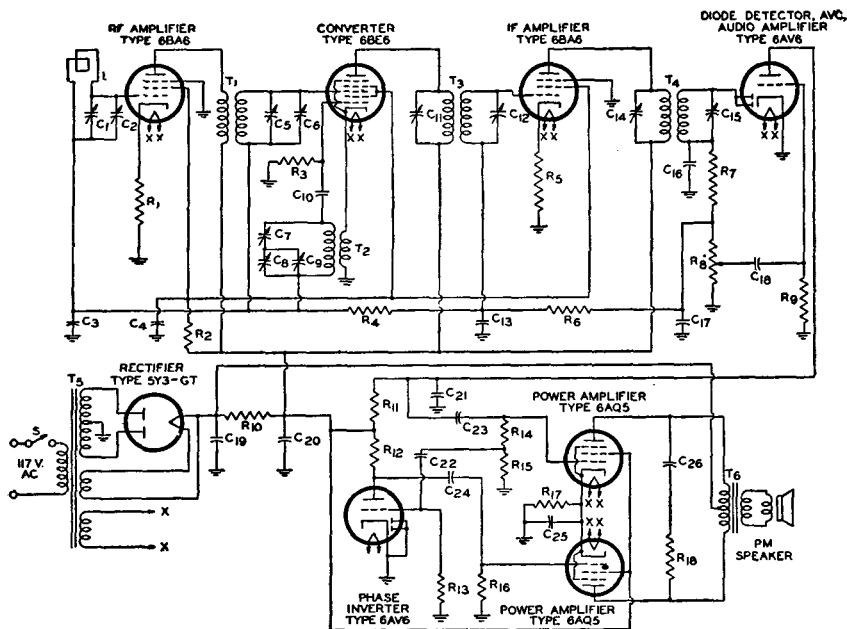

C<sub>1</sub> C<sub>3</sub> C<sub>8</sub>=Ganged tuning capacitors, 10-365  $\mu$ f  
 C<sub>2</sub> C<sub>6</sub> C<sub>9</sub>=Trimmer capacitors, 4-30  $\mu$ f  
 C<sub>3</sub> C<sub>13</sub>=0.05  $\mu$ f, paper, 50 v.  
 C<sub>4</sub>=0.05  $\mu$ f, paper, 400 v.  
 C<sub>7</sub>=Oscillator padding capacitor—follow oscillator-coil manufacturer's recommendation  
 C<sub>10</sub>=56  $\mu$ f, mica  
 C<sub>11</sub> C<sub>12</sub> C<sub>14</sub> C<sub>15</sub>=Trimmer capacitors for if transformers  
 C<sub>16</sub> C<sub>17</sub>=180  $\mu$ f, mica  
 C<sub>18</sub> C<sub>22</sub>=0.01  $\mu$ f, paper, 400 v.  
 C<sub>19</sub> C<sub>20</sub>=20  $\mu$ f, electrolytic, 450 v.

C<sub>21</sub>=120  $\mu$ f, mica  
 C<sub>23</sub> C<sub>24</sub>=0.02  $\mu$ f, paper, 400 v.  
 C<sub>25</sub>=20  $\mu$ f, electrolytic, 50 v.  
 C<sub>26</sub>=0.05  $\mu$ f, paper, 600 v.  
 L=Loop antenna, 540-1600 Kc  
 R<sub>1</sub> R<sub>4</sub>=180 ohms, 0.5 watt  
 R<sub>2</sub>=12000 ohms, 2 watts  
 R<sub>3</sub>=22000 ohms, 0.5 watt  
 R<sub>4</sub> R<sub>5</sub>=2.2 megohms, 0.5 watt  
 R<sub>7</sub>=100000 ohms, 0.5 watt  
 R<sub>8</sub>=Volume control, potentiometer, 1 megohm  
 R<sub>9</sub> R<sub>13</sub>=10 megohms, 0.5 watt  
 R<sub>10</sub>=1800 ohms, 2 watts  
 R<sub>11</sub> R<sub>12</sub>=220000 ohms, 0.5 watt  
 R<sub>14</sub> R<sub>16</sub>=470000 ohms, 0.5 watt  
 R<sub>15</sub>=8200 ohms, 0.5 watt

R<sub>17</sub>=270 ohms, 5 watts  
 R<sub>18</sub>=15000 ohms, 1 watt  
 S=Switch on volume control  
 T<sub>1</sub>=RF transformer, 540-1600 Kc  
 T<sub>2</sub>=Oscillator coil for use with 10-365- $\mu$ f tuning capacitor and 455-Kc if transformer  
 T<sub>3</sub> T<sub>4</sub>=Intermediate-frequency transformers, 455 Kc  
 T<sub>5</sub>=Power transformer, 250-0-250 volts rms, 120 ma. dc  
 T<sub>6</sub>=Output transformer for matching impedance of voice coil to a 10000-ohm plate-to-plate tube load

(17-4)

### AC/DC SUPERHETERODYNE RECEIVER

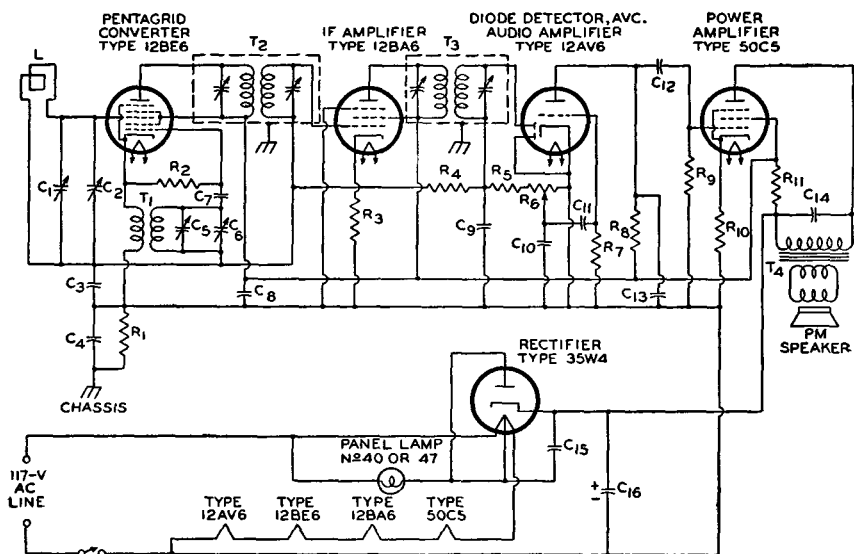

$C_1$   $C_5$ =Ganged tuning capacitors;  $C_1$ , 10-365  $\mu\text{f}$ ;  $C_5$ , 7-115  $\mu\text{f}$   
 $C_2$ =Trimmer capacitor, 4-30  $\mu\text{f}$   
 $C_3$ =0.05  $\mu\text{f}$ , paper, 50 v.  
 $C_4$ =0.1  $\mu\text{f}$ , paper, 400 v.  
 $C_4$ =Trimmer capacitor, 2-17  $\mu\text{f}$   
 $C_7$ =56  $\mu\text{f}$ , ceramic  
 $C_8$ =50  $\mu\text{f}$ , electrolytic, 150 v.  
 $C_9$   $C_{10}$ =150  $\mu\text{f}$ , ceramic  
 $C_{11}$   $C_{14}$ =0.02  $\mu\text{f}$ , paper, 400 v.  
 $C_{12}$ =0.002  $\mu\text{f}$ , paper, 400 v.

$C_{12}$ =330  $\mu\text{f}$ , mica  
 $C_{15}$ =0.05  $\mu\text{f}$ , paper, 400 v.  
 $C_{16}$ =30  $\mu\text{f}$ , electrolytic, 150 v.  
 $L$ =Loop antenna, 540-1600 Kc  
 $R_1$   $R_8$ =220000 ohms, 0.5 watt  
 $R_2$ =22000 ohms, 0.5 watt  
 $R_3$ =100 ohms, 0.5 watt  
 $R_4$ =3.3 megohms, 0.5 watt  
 $R_5$ =47000 ohms, 0.5 watt  
 $R_6$ =Volume control, potentiometer, 500000 ohms  
 $R_7$ =4.7 megohms, 0.5 watt

$R_9$ =470000 ohms, 0.5 watt  
 $R_{10}$ =150 ohms, 0.5 watt  
 $R_{11}$ =1200 ohms, 1 watt  
 $T_1$ =Oscillator coil for use with 7-115- $\mu\text{f}$  tuning capacitor and 455-Kc intermediate-frequency transformer  
 $T_2$   $T_3$ =Intermediate-frequency transformers, 455 Kc  
 $T_4$ =Output transformer for matching impedance of voice coil to 2500-ohm tube load

(17-5)

## AUTOMOBILE RECEIVER

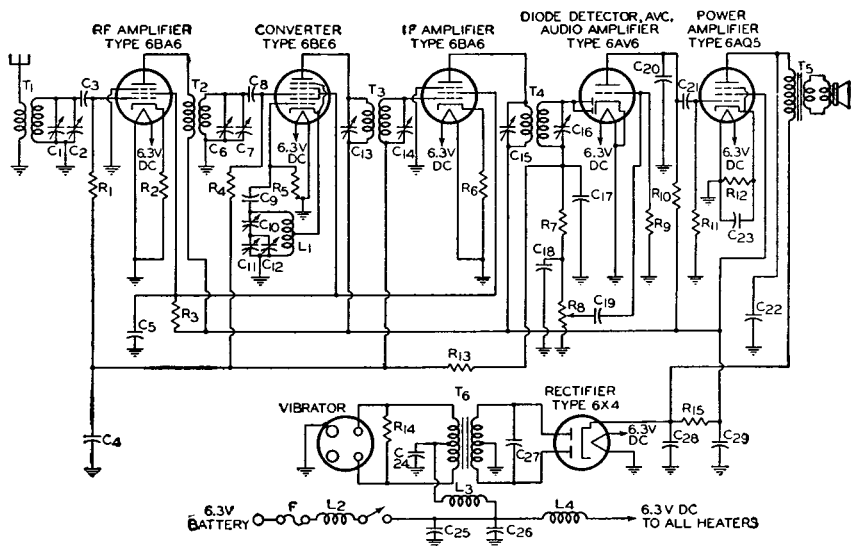

**C<sub>1</sub> C<sub>7</sub> C<sub>11</sub>** = Ganged tuning capacitors, 10-365  $\mu$ f  
**C<sub>2</sub> C<sub>5</sub> C<sub>12</sub>** = Trimmer capacitors, 4-30  $\mu$ f  
**C<sub>3</sub> C<sub>8</sub>** = 220  $\mu$ f, mica  
**C<sub>4</sub>** = 0.05  $\mu$ f, paper, 50 v.  
**C<sub>5</sub>** = 0.05  $\mu$ f, paper, 300 v.  
**C<sub>9</sub>** = 47  $\mu$ f, mica  
**C<sub>10</sub>** = Oscillator padding capacitor—follow oscillator manufacturer's recommendation  
**C<sub>13</sub> C<sub>14</sub> C<sub>15</sub> C<sub>16</sub>** = Trimmer capacitors for if transformers  
**C<sub>17</sub> C<sub>18</sub>** = 100  $\mu$ f, mica  
**C<sub>19</sub>** = 0.01  $\mu$ f, paper, 300 v.  
**C<sub>20</sub>** = 120  $\mu$ f, mica  
**C<sub>21</sub>** = 0.005  $\mu$ f, paper, 300 v.  
**C<sub>22</sub>** = 0.005  $\mu$ f, paper, 450 v.

**C<sub>23</sub>** = 20  $\mu$ f, electrolytic, 25 v.  
**C<sub>24</sub> C<sub>25</sub>** = 0.5  $\mu$ f, paper, 50 v.  
**C<sub>26</sub>** = 470  $\mu$ f, mica  
**C<sub>27</sub>** = 0.006  $\mu$ f, paper, 1500 v.  
**C<sub>28</sub> C<sub>29</sub>** = 20  $\mu$ f, electrolytic, 450 v.  
**F** = Fuse, 10 a.  
**L<sub>1</sub>** = Oscillator coil, tapped, for use with 365- $\mu$ f tuning capacitor, and 455 Kc if transformer  
**L<sub>2</sub> L<sub>3</sub> L<sub>4</sub>** = RF choke, 10 a.  
**R<sub>1</sub> R<sub>4</sub>** = 1 megohm, 0.5 watt  
**R<sub>2</sub>** = 150 ohms, 0.5 watt  
**R<sub>3</sub>** = 12000 ohms, 2 watts  
**R<sub>5</sub>** = 22000 ohms, 0.5 watt  
**R<sub>6</sub>** = 100 ohms, 0.5 watt  
**R<sub>7</sub>** = 47000 ohms, 0.5 watt  
**R<sub>8</sub>** = Volume control, potentiometer, 1 megohm

**R<sub>9</sub>** = 10 megohms, 0.5 watt  
**R<sub>10</sub>** = 270000 ohms, 0.5 watt  
**R<sub>11</sub>** = 470000 ohms, 0.5 watt  
**R<sub>12</sub>** = 390 ohms, 2 watts  
**R<sub>13</sub>** = 2.2 megohms, 0.5 watt  
**R<sub>14</sub>** = 220 ohms, 0.5 watt  
**R<sub>15</sub>** = 1500 ohms, 1 watt  
**T<sub>1</sub> T<sub>2</sub>** = RF transformers, 540-1600 Kc  
**T<sub>3</sub> T<sub>4</sub>** = Intermediate-frequency transformers, 455 Kc  
**T<sub>5</sub>** = Output transformer for matching impedance of voice coil to 5000-ohm tube load  
**T<sub>6</sub>** = Vibrator transformer, Stancor P-4062, or equivalent  
**Vibrator** = Mallory Type No. 859, or equivalent

NOTE: This circuit may be readily adapted for operation from a 12.6-volt dc source by the choice of a suitable vibrator and vibrator transformer, and by the substitution of the following RCA tube types for those shown in the diagram: RF AMPLIFIER, 12BA6; CONVERTER, 12BE6; IF AMPLIFIER, 12BA6; DIODE DETECTOR, AVC, AUDIO AMPLIFIER, 12AV6; POWER AMPLIFIER, 12AQ5; RECTIFIER, 12X4. Recommendations as to suitable vibrators and vibrator transformers may be obtained from manufacturers of these components. For 12.6-volt operation the voltage rating of C<sub>24</sub> and C<sub>25</sub> should be increased to 100 volts.

(17-6)

### SUPERREGENERATIVE RECEIVER

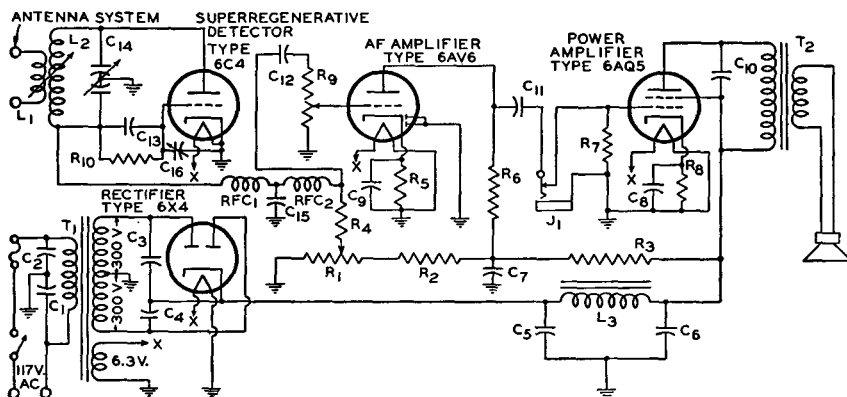

**C<sub>1</sub> C<sub>2</sub>** = 0.1  $\mu$ f, paper, 400 v.  
**C<sub>3</sub> C<sub>4</sub>** = 100  $\mu$ f, mica, 500 v.  
**C<sub>5</sub> C<sub>6</sub> C<sub>7</sub>** = 20  $\mu$ f, electrolytic, 450 v.  
**C<sub>8</sub>** = 25  $\mu$ f, electrolytic, 50 v.  
**C<sub>9</sub>** = 25  $\mu$ f, electrolytic, 25 v.  
**C<sub>10</sub>** = 0.002  $\mu$ f, paper, 600 v.  
**C<sub>11</sub>** = 0.01  $\mu$ f, paper, 400 v.  
**C<sub>12</sub>** = 0.005  $\mu$ f, paper, 400 v.  
**C<sub>13</sub>** = 50  $\mu$ f, silver mica, 300 v.  
**C<sub>14</sub>** = Ganged or split-stator tuning capacitor, 10  $\mu$ f max. per section  
**C<sub>15</sub>** = 0.006  $\mu$ f, mica, 300 v.  
**C<sub>16</sub>** = Quench-frequency control,

trimmer capacitor, 3-30  $\mu$ f, ceramic or mica  
**J<sub>1</sub>** = Jack for earphones  
**L<sub>1</sub>** = Antenna pickup winding  
**L<sub>2</sub>** = 4 turns of No. 12 Enam. copper wire on a  $\frac{1}{2}$ " I.D. form (144 Mc): adjust spacing to set band  
**L<sub>3</sub>** = Speaker field or filter choke, 12 henries, 70 ma.  
**R<sub>1</sub>** = Potentiometer, 50000 ohms, 1 watt, wire wound  
**R<sub>2</sub> R<sub>3</sub>** = 47000 ohms, 1 watt  
**R<sub>4</sub>** = 27000 ohms, 0.5 watt  
**R<sub>5</sub>** = 2700 ohms, 1 watt

**R<sub>6</sub> R<sub>7</sub>** = 100000 ohms, 0.5 watt  
**R<sub>8</sub>** = 270 ohms, 1 watt  
**R<sub>9</sub>** = Volume control, potentiometer, 500000 ohms  
**R<sub>10</sub>** = 4.7 megohms, 0.5 watt  
**RFC<sub>1</sub>** = One-quarter wavelength (20.5 inches at 144 Mc) of No. 23 Enam. close wound on a  $\frac{1}{4}$ " form  
**RFC<sub>2</sub>** = RF choke, 8 mh.  
**T<sub>1</sub>** = Power transformer, 300-0-300 volts rms, 70 ma.  
**T<sub>2</sub>** = Output transformer for matching impedance of voice coil to 5000-ohm tube load

(17-7)

### BATTERY-OPERATED SHORT-WAVE RECEIVER

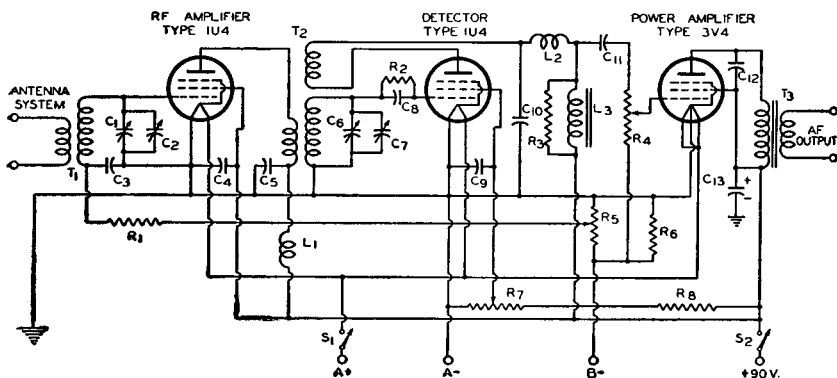

**C<sub>1</sub> C<sub>6</sub>**=Ganged band-setting capacitors, 140  $\mu\text{f}$ , maximum per section  
**C<sub>2</sub> C<sub>7</sub>**=Ganged band-tuning capacitors, 35  $\mu\text{f}$  maximum per section  
**C<sub>3</sub> C<sub>4</sub> C<sub>5</sub> C<sub>11</sub>**=0.05  $\mu\text{f}$   
**C<sub>8</sub> C<sub>10</sub>**=250  $\mu\text{f}$ , mica  
**C<sub>9</sub>**=1  $\mu\text{f}$ , paper, 100 v.  
**C<sub>12</sub>**=0.002  $\mu\text{f}$ , paper, 400 v.  
**C<sub>13</sub>**=8  $\mu\text{f}$ , electrolytic, 150 v.  
**L<sub>1</sub> L<sub>2</sub>** = RF chokes, 8 mh.

**L<sub>3</sub>** = AF choke, 300-500 h.  
**R<sub>1</sub>** = 100000 ohms, 0.5 watt  
**R<sub>2</sub>** = 2 - 5 megohm, 0.5 watt  
**R<sub>3</sub>**=270000 ohms, 0.5 watt  
**R<sub>4</sub>** = Volume control, potentiometer, 500000 ohms  
**R<sub>5</sub>**=RF gain control, potentiometer, 50000 ohms  
**R<sub>6</sub>**=470 ohms, 0.5 watt  
**R<sub>7</sub>**=Regeneration control, potentiometer, 50000 ohms  
**R<sub>8</sub>**=33000 ohms, 0.5 watt

**S<sub>1</sub> S<sub>2</sub>** = Ganged switch, double-pole, single-throw  
**T<sub>1</sub>** = RF coil of the 4-prong, 2-winding, plug-in type for use with 140- $\mu\text{f}$  tuning capacitor  
**T<sub>2</sub>** = Regenerative detector coil of the 6-prong, 3-winding, plug-in type for use with 140- $\mu\text{f}$  tuning capacitor  
**T<sub>3</sub>** = Output transformer for matching impedance of voice coil to 9000-ohm tube load

(17-8)

TRF AM TUNER

For High-Fidelity Local Broadcast Reception

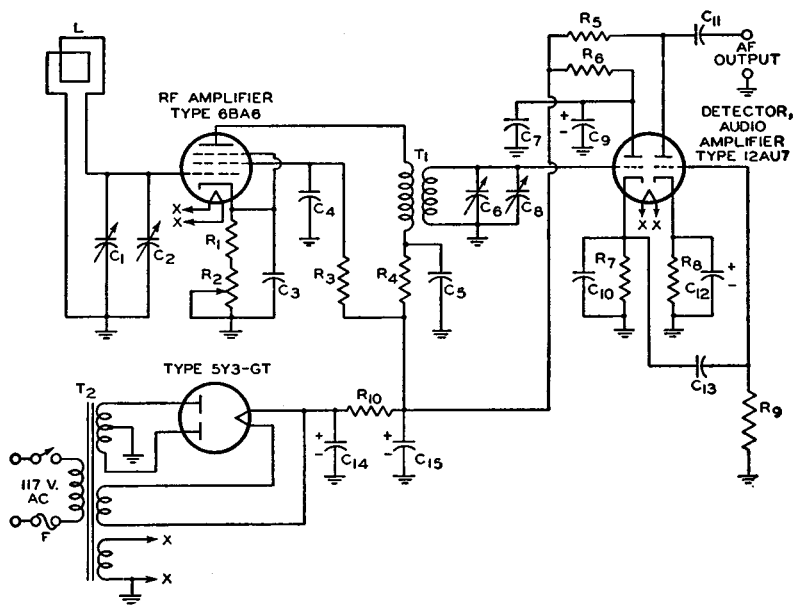

C<sub>1</sub> C<sub>5</sub>=Ganged tuning capacitors, 10-365  $\mu$ f  
 C<sub>2</sub> C<sub>3</sub>=Trimmer capacitors, 4-30  $\mu$ f  
 C<sub>4</sub>=0.01  $\mu$ f, paper or ceramic, 200 v.  
 C<sub>6</sub>=0.01  $\mu$ f, paper or ceramic, 400 v.  
 C<sub>7</sub> C<sub>11</sub>=0.1  $\mu$ f, paper, 400 v.  
 C<sub>8</sub>=250  $\mu$ f, mica or ceramic, 400 v.

C<sub>9</sub>=10  $\mu$ f, electrolytic, 350 v.  
 C<sub>10</sub>=250  $\mu$ f, mica or ceramic, 200 v.  
 C<sub>12</sub>=25  $\mu$ f, electrolytic, 25 v.  
 C<sub>13</sub>=0.05  $\mu$ f, paper, 200 v.  
 C<sub>14</sub> C<sub>15</sub>=20  $\mu$ f, electrolytic, 450 v.  
 F=Fuse, 1 ampere  
 L=Loop antenna, 540-1600 Kc.  
 R<sub>1</sub>=180 ohms, 0.5 watt  
 R<sub>2</sub>=Volume control, potentiometer, 5000 ohms

R<sub>3</sub>=33000 ohms, 1 watt  
 R<sub>4</sub> R<sub>4</sub>=1000 ohms, 0.5 watt  
 R<sub>5</sub>=100000 ohms, 0.5 watt  
 R<sub>6</sub>=150000 ohms, 0.5 watt  
 R<sub>7</sub>=15000 ohms, 0.5 watt  
 R<sub>8</sub>=1500 ohms, 0.5 watt  
 R<sub>9</sub>=470000 ohms, 0.5 watt  
 R<sub>10</sub>=7000 ohms, 10 watts  
 T<sub>1</sub>=RF transformer, 540-1600 Kc.  
 T<sub>2</sub>=Power transformer, 250-0-250 volts rms, 40 ma.

(17-9)

FM TUNER

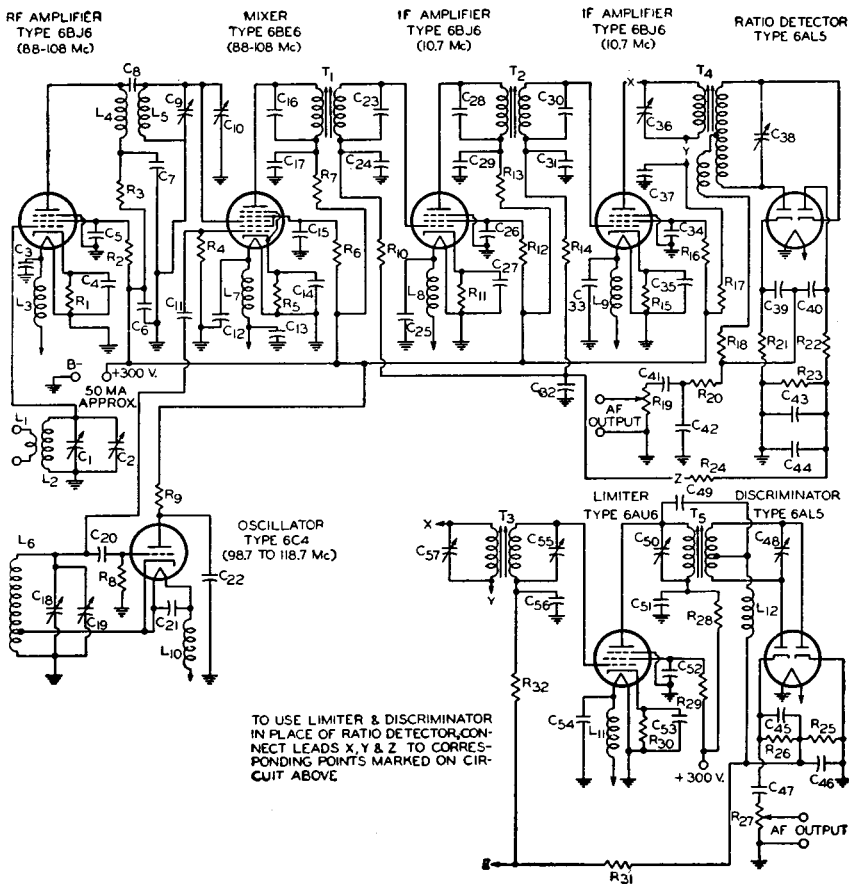



(17-9)

### FM TUNER (Cont'd)

- |   |  |   |
|---|--|---|
| <p>C<sub>1</sub> C<sub>9</sub> C<sub>18</sub> = Ganged tuning capacitors, 7.5 - 20 <math>\mu\mu\text{f}</math></p> <p>C<sub>7</sub> C<sub>10</sub> C<sub>19</sub> = Trimmer capacitors, 1.5 - 5.0 <math>\mu\mu\text{f}</math>, ceramic</p> <p>C<sub>2</sub> = 0.01 <math>\mu\text{f}</math>, ceramic or mica, 200 v.</p> <p>C<sub>4</sub> C<sub>14</sub> C<sub>24</sub> C<sub>27</sub> C<sub>31</sub> C<sub>35</sub> C<sub>38</sub> C<sub>56</sub> = 1500 <math>\mu\mu\text{f}</math>, ceramic or mica, 200 v.</p> <p>C<sub>5</sub> C<sub>7</sub> C<sub>15</sub> C<sub>17</sub> C<sub>23</sub> C<sub>26</sub> C<sub>29</sub> C<sub>34</sub> C<sub>37</sub> C<sub>55</sub> = 1500 <math>\mu\mu\text{f}</math>, ceramic or mica, 400 v.</p> <p>C<sub>6</sub> = 0.1 <math>\mu\text{f}</math>, paper, 400 v.</p> <p>C<sub>8</sub> = 33 <math>\mu\mu\text{f}</math>, mica, 400 v.</p> <p>C<sub>11</sub> = 3 <math>\mu\mu\text{f}</math>, silver mica, 200 v.</p> <p>C<sub>12</sub> C<sub>13</sub> C<sub>25</sub> C<sub>32</sub> C<sub>33</sub> C<sub>54</sub> = 0.01 <math>\mu\text{f}</math>, ceramic or mica, 200 v.</p> <p>C<sub>16</sub> C<sub>22</sub> C<sub>28</sub> C<sub>30</sub> C<sub>36</sub> C<sub>38</sub> C<sub>48</sub> C<sub>49</sub> C<sub>50</sub> C<sub>55</sub> C<sub>57</sub> = Trimmer capacitors, 22-50 <math>\mu\mu\text{f}</math>, mica, usually part of if transformer</p> <p>C<sub>20</sub> = 33 <math>\mu\mu\text{f}</math>, silver mica, 200 v.</p> <p>C<sub>21</sub> = 100 <math>\mu\mu\text{f}</math>, ceramic or mica, 200 v.</p> <p>C<sub>19</sub> C<sub>40</sub> = 330 <math>\mu\mu\text{f}</math>, ceramic or mica, 200 v.</p> <p>C<sub>41</sub> = 0.05 <math>\mu\text{f}</math>, paper, 200 v.</p> <p>C<sub>42</sub> C<sub>43</sub> = 0.005 <math>\mu\text{f}</math>, ceramic or paper, 200 v.</p> <p>C<sub>44</sub> = 10 <math>\mu\text{f}</math>, electrolytic, 200 v.</p> | <p>C<sub>45</sub> C<sub>46</sub> = 250 <math>\mu\mu\text{f}</math>, ceramic or mica, 200 v.</p> <p>C<sub>47</sub> = 0.1 <math>\mu\text{f}</math>, paper, 200 v.</p> <p>C<sub>51</sub> = 500 <math>\mu\mu\text{f}</math>, ceramic or mica, 400 v.</p> <p>L<sub>1</sub> = 1 turn of No.14 Enam. wound on a <math>\frac{3}{4}</math>" diam. coil form</p> <p>L<sub>2</sub> = 2.5 turns of No.14 Enam. spaced 1 wire diameter wound on same form as L<sub>1</sub> with the ground end of L<sub>2</sub> spaced <math>\frac{3}{4}</math>" from L<sub>1</sub></p> <p>L<sub>3</sub> L<sub>4</sub> L<sub>7</sub> L<sub>8</sub> L<sub>9</sub> L<sub>10</sub> L<sub>11</sub> = Choke, 1 <math>\mu\text{h}</math> (approx.), 25 turns of No.24 Enam. close-wound on resistor (47000 ohms, 0.5 watt), connected in parallel with resistor.</p> <p>L<sub>5</sub> = 2.5 turns of No.14 Enam. spaced 1 wire diameter, wound on <math>\frac{3}{4}</math>" form.</p> <p>L<sub>6</sub> = 2 turns of No.14 Enam. spaced 1 wire diameter, wound on <math>\frac{3}{4}</math>" form, tapped at <math>\frac{1}{2}</math> turn from ground end</p> <p>L<sub>12</sub> = Choke, 2.5 mh. (may not be required; follow transformer manufacturer's recommendation)</p> | <p>R<sub>1</sub> R<sub>11</sub> R<sub>15</sub> R<sub>30</sub> = 120 ohms, 0.5 watt</p> <p>R<sub>2</sub> R<sub>12</sub> R<sub>16</sub> = 39000 ohms, 0.5 watt</p> <p>R<sub>3</sub> R<sub>7</sub> R<sub>13</sub> R<sub>17</sub> = 470 ohms, 0.5 watt</p> <p>R<sub>4</sub> R<sub>23</sub> R<sub>28</sub> = 10000 ohms, 0.5 watt</p> <p>R<sub>5</sub> = 47 ohms, 0.5 watt</p> <p>R<sub>6</sub> = 33000 ohms, 1 watt</p> <p>R<sub>8</sub> = 47000 ohms, 0.5 watt</p> <p>R<sub>9</sub> = 4700 ohms, 1 watt</p> <p>R<sub>10</sub> R<sub>14</sub> R<sub>32</sub> = 220000 ohms, 0.5 watt</p> <p>R<sub>18</sub> = 56 ohms, 0.5 watt</p> <p>R<sub>19</sub> R<sub>27</sub> = Volume controls, potentiometers, 1 megohm</p> <p>R<sub>20</sub> = 15000 ohms, 0.5 watt</p> <p>R<sub>21</sub> = 820 ohms, 0.5 watt</p> <p>R<sub>22</sub> = 560 ohms, 0.5 watt</p> <p>R<sub>24</sub> R<sub>41</sub> = 2.2 megohms, 0.5 watt</p> <p>R<sub>25</sub> R<sub>26</sub> = 100000 ohms, 0.5 watt</p> <p>R<sub>29</sub> = 150000 ohms, 1 watt</p> <p>T<sub>1</sub> T<sub>2</sub> T<sub>3</sub> = Intermediate-frequency transformers, 10.7 Mc</p> <p>T<sub>4</sub> = Ratio-detector transformer, 10.7 Mc</p> <p>T<sub>5</sub> = Discriminator transformer, 10.7 Mc</p> |
|---|--|---|

NOTE: A high-frequency de-emphasis network having a time constant of 75 microseconds (such as that formed by R<sub>20</sub> and C<sub>42</sub>) should be inserted between R<sub>28</sub> and C<sub>47</sub> in the discriminator output lead.

Fig. 17-9 illustrates a circuit for an FM broadcast tuner. The basic circuit has been arranged to show the use of a ratio detector, but the limiter/discriminator circuit shown in the lower right-hand corner of the diagram can be substituted as indicated at points X, Y, and Z in the schematic.

A word of caution is necessary in connection with this circuit. Because it works at very high frequencies and is required to handle a very wide bandwidth, its construction requires more than ordinary skill and experience. Placement of component parts is quite critical and may require considerable experimentation. All rf leads to components including bypass capacitors must be kept short and must be properly dressed to minimize undesirable coupling and capacitance effects. Correct circuit alignment and oscillator tracking require the use of a cathode-ray oscilloscope, a high-impedance vacuum-tube voltmeter, and a signal generator capable of supplying a frequency-modulated signal on 10.7 Mc as well as accurate marker signals in the 88-108-Mc band. Unless the builder has the necessary equipment and has had considerable experience with broad-band, high-frequency circuits, he should not undertake the construction of this circuit.

(17-10)

## MICROPHONE AND PHONOGRAPH AMPLIFIER

Power Output, 6 Watts

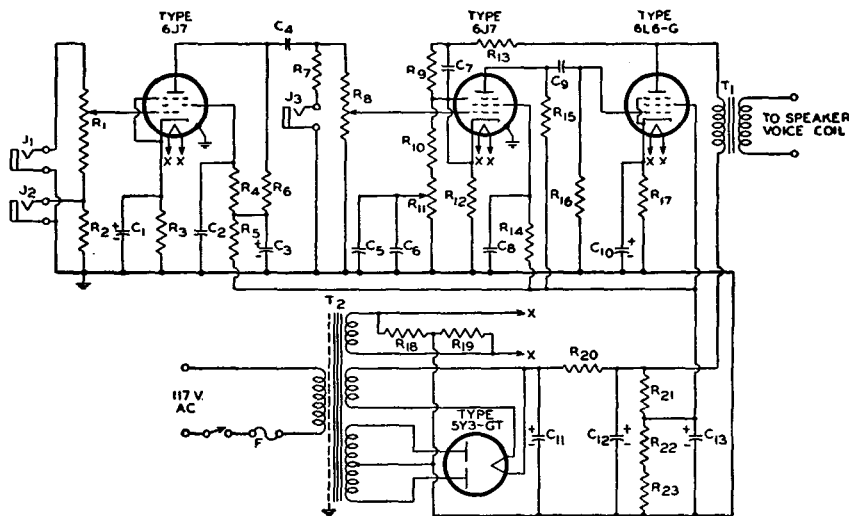

$C_1=16 \mu\text{f}$ , electrolytic, 150 v.  
 $C_2 C_3=0.1 \mu\text{f}$ , paper, 400 v.  
 $C_3 C_{12}=10 \mu\text{f}$ , electrolytic, 450 v.  
 $C_4 C_9=0.05 \mu\text{f}$ , paper, 400 v.  
 $C_5=0.1 \mu\text{f}$ , paper, 200 v.  
 $C_6=0.25 \mu\text{f}$ , paper, 200 v.  
 $C_7=820 \mu\text{mf}$ , mica, 500 v.  
 $C_{10}=20 \mu\text{f}$ , electrolytic, 25 v.  
 $C_{11} C_{12}=25 \mu\text{f}$ , electrolytic, 450 v.  
 F=Fuse, 1 ampere  
 $J_1$ =Jack for high-impedance crystal microphone input, maximum input: 2 volts peak  
 $J_2$ =Jack for low-impedance

phono-pickup input, maximum input: 0.135 volt peak  
 $J_3$ =Jack for high-impedance phono-pick up input, maximum input: 20 volts peak  
 $R_1 R_8$ =Volume control, potentiometer, 500000 ohms  
 $R_2=2200$  ohms, 0.5 watt  
 $R_3=1500$  ohms, 0.5 watt  
 $R_4 R_{14}=1.2$  megohms, 0.5 watt  
 $R_5 R_{13}=82000$  ohms, 0.5 watt  
 $R_6=270000$  ohms, 0.5 watt  
 $R_7 R_9=470000$  ohms, 0.5 watt  
 $R_{10}=47$  ohms, 0.5 watt

$R_{11}$ =Tone control, potentiometer, 5000 ohms  
 $R_{12}=1000$  ohms, 0.5 watt  
 $R_{15}=220000$  ohms, 0.5 watt  
 $R_{16}=330000$  ohms, 0.5 watt  
 $R_{17}=220$  ohms, 2 watts  
 $R_{18} R_{19}=33$  ohms, 0.5 watt  
 $R_{20}=440$  ohms, 10 watts  
 $R_{21}=8200$  ohms, 0.5 watt  
 $R_{22} R_{23}=33000$  ohms, 2 watts  
 $T_1$ =Output transformer for matching impedance of voice coil to 4000-ohm tube load  
 $T_2$ =Power transformer, 350-0-350 volts rms, 125 ma.

(17-11)

## HIGH-FIDELITY AUDIO AMPLIFIER

Class AB<sub>1</sub>; Output, 10 Watts

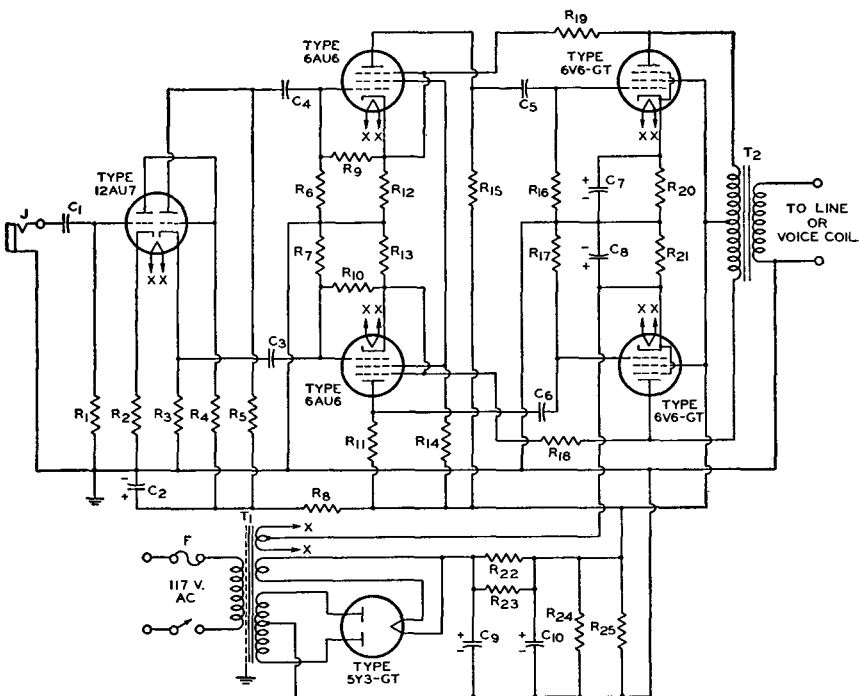

$C_1 = 0.1 \mu\text{f}$ , paper, 600 v.  
 $C_2 = 40 \mu\text{f}$ , electrolytic, 450 v.  
 $C_3, C_4 = 0.02 \mu\text{f}$ , paper, 600 v.  
 $C_5, C_6 = 0.05 \mu\text{f}$ , paper, 600 v.  
 $C_7, C_8 = 50 \mu\text{f}$ , electrolytic, 50 v.  
 $C_9, C_{10} = 80 \mu\text{f}$ , electrolytic, 450 v.  
 F = Fuse, 1 ampere  
 $R_1 = 470000$  ohms, 0.5 watt  
 $R_2 = 6800$  ohms, 0.5 watt  
 $R_3, R_5 = 39000$  ohms  $\pm 1$  per cent,  
 matched, 1 watt

$R_4 = 220000$  ohms, 0.5 watt  
 $R_6, R_7, R_{14} = 1$  megohm, 0.5 watt  
 $R_8 = 10000$  ohms, 1 watt  
 $R_9, R_{10}, R_{11}, R_{13}, R_{16}, R_{17} = 330000$   
 ohms, 0.5 watt  
 $R_{12}, R_{13} = 1800$  ohms  $\pm 1$  per cent,  
 matched, 0.5 watt  
 $R_{18}, R_{19} = \text{Carbon-film type,}$   
 100000 ohms  $\pm 1$  per cent,  
 matched, 2 watts  
 $R_{20}, R_{21} = 510$  ohms, 2 watts

$R_{22}, R_{23} = 390$  ohms, 2 watts  
 $R_{24}, R_{25} = 150000$  ohms, 2 watts  
 S = Switch, single-pole, single-  
 throw  
 $T_1 = \text{Output transformer for}$   
 matching line or voice coil im-  
 pedance to 9000-10000-ohm  
 plate-to-plate tube load  
 $T_2 = \text{Power transformer,}$   
 350-0-350 volts rms, 125 ma.

(17-12)

## HIGH-POWER AUDIO AMPLIFIER

Class AB<sub>1</sub>; Output, 25 Watts

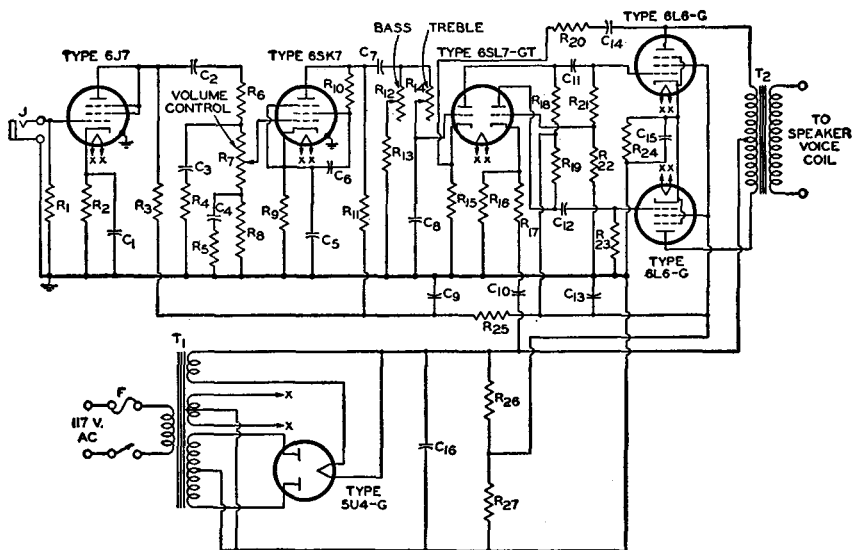

$C_1$   $C_3$   $C_{13}$  = 20  $\mu$ f, electrolytic, 25 v.  
 $C_2$   $C_4$   $C_7$  = 0.01  $\mu$ f, paper, 600 v.  
 $C_4$  = 0.005  $\mu$ f, paper, 100 v.  
 $C_6$  = 0.5  $\mu$ f, paper, 600 v.  
 $C_8$  = 330  $\mu$ f, mica  
 $C_9$   $C_{11}$  = 30  $\mu$ f, electrolytic, 450 v.  
 $C_{10}$   $C_{11}$   $C_{12}$   $C_{14}$  = 0.1  $\mu$ f, paper, 600 v.  
 $C_{16}$  = 40  $\mu$ f, electrolytic, 450 v.  
 F = Fuse, 3 amperes  
 J = Jack for high-impedance phono-pickup input  
 $R_1$  = 1 megohm, 0.5 watt  
 $R_5$  = 1800 ohms, 0.5 watt

$R_3$   $R_4$  = 82000 ohms, 0.5 watt  
 $R_5$   $R_{13}$  = 47000 ohms, 0.5 watt  
 $R_6$   $R_7$   $R_8$  = Volume control, potentiometer, 1.5 megohm, tapped at 250000 and 500000 ohms.  $R_8$  is 250000-ohm section.  
 $R_9$  = 390 ohms, 0.5 watt  
 $R_{10}$  = 120000 ohms, 0.5 watt  
 $R_{11}$  = 15000 ohms, 0.5 watt  
 $R_{12}$  = Bass control, potentiometer, 500000 ohms  
 $R_{14}$  = Treble control, potentiometer 500000 ohms,  
 $R_{15}$   $R_{16}$  = 4700 ohms, 0.5 watt

$R_{17}$  = 250000 ohms, 0.5 watt  
 $R_{18}$   $R_{19}$  = 220000 ohms, 1 watt  
 $R_{20}$  = 560000 ohms, 0.5 watt  
 $R_{21}$   $R_{22}$  = 270000 ohms, 0.5 watt  
 $R_{23}$  = 12000 ohms, 0.5 watt  
 $R_{24}$  = 185 ohms, 10 watts  
 $R_{25}$  = 10000 ohms, 1 watt  
 $R_{26}$  = 2000 ohms, 20 watts  
 $R_{27}$  = 12500 ohms, 20 watts  
 $T_1$  = Power transformer, 400-0-400 volts rms, 200 ma.  
 $T_2$  = Output transformer for matching impedance of voice coil to 6600-ohm plate-to-plate tube load

NOTE: The value of  $R_{17}$  should be adjusted for minimum power-supply ripple in output.

(17-13)

### CLASS B AMPLIFIER FOR MOBILE USE

Power Output 10 Watts\*

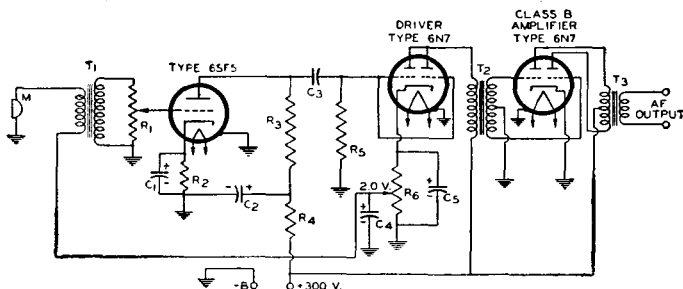

$C_1 = 5 \mu\text{f}$ , electrolytic, 25 v.  
 $C_2 = 4 \mu\text{f}$ , electrolytic, 250 v.  
 $C_3 = 0.025 \mu\text{f}$ , paper, 400 v.  
 $C_4 = 25 \mu\text{f}$ , electrolytic, 25 v.  
 $C_5 = 50 \mu\text{f}$ , electrolytic, 25 v.  
 M = Microphone, single-button carbon, 200 ohms  
 $R_1$  = Volume control, potentiometer, 500000 ohms

$R_2 = 1300$  ohms, 0.5 watt  
 $R_3, R_5 = 100000$  ohms, 0.5 watt  
 $R_4 = 47000$  ohms, 0.5 watt  
 $R_6$  = Voltage control, variable resistor, 1000 ohms, set for 2.0 volts  
 $T_1$  = Transformer for matching a single-button microphone to a single grid

$T_2$  = Input transformer for matching parallel-connected 6N7 driver to a 6N7 class B amplifier  
 $T_3$  = Output transformer for matching impedance of voice coil to 8000-ohm plate-to-plate tube load

\* Peak signal-input voltage to 6SF5 grid required for full power output is 0.15 volt.

(17-14)

### TWO-CHANNEL AUDIO MIXER

Voltage Gain From Each Grid of 6SC7 to Output is Approximately 15

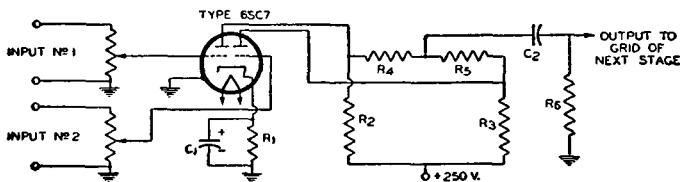

$C_1 = 10 \mu\text{f}$ , electrolytic, 25 v.  
 $C_2 = 0.005 \mu\text{f}$ , paper, 400 v.

$R_1 = 2200$  ohms, 0.5 watt

$R_2, R_3 = 270000$  ohms, 0.5 watt  
 $R_4, R_5, R_6 = 1$  megohm, 0.5 watt

(17-15)

PREAMPLIFIER FOR MAGNETIC PHONOGRAPH PICKUP

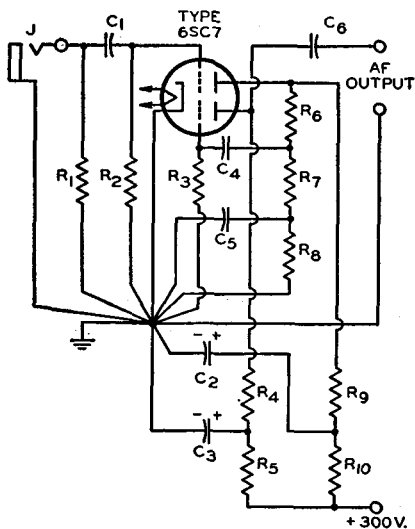

$C_1 C_4 C_6=0.05 \mu f$ , paper, 600 v.  
 $C_2 C_3=20 \mu f$ , electrolytic, 450 v.  
 $C_5=0.01 \mu f$ , paper, 600 v.  
 J=Input connector, shielded

$R_1$ =Value depends on type of magnetic pickup used. Follow pickup manufacturer's recommendations

$R_2 R_3=3.3$  megohms, 0.5 watt  
 $R_4 R_5=33000$  ohms, 0.5 watt  
 $R_6=200000$  ohms, 0.5 watt  
 $R_7=27000$  ohms, 0.5 watt  
 $R_8=180000$  ohms, 0.5 watt

(17-16)

LOW-DISTORTION INPUT AMPLIFIER STAGE

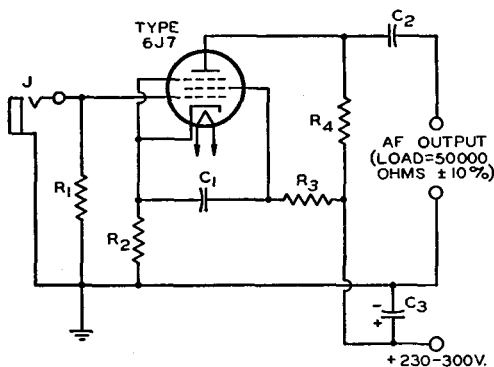

$C_1=0.25 \mu f$ , paper, oil-filled, 600 v.  
 $C_2=0.5 \mu f$ , paper, oil-filled, 600 v.  
 $C_3=40 \mu f$ , electrolytic, 350 v.

J=Input connector, shielded  
 $R_1=50000$  to  $100000$  ohms to match source impedance, 0.5 watt  
 $R_2=910$  ohms  $\pm 5$  per cent, 0.5

watt, wire-wound  
 $R_3=270000$  ohms  $\pm 5$  per cent, 0.5 watt  
 $R_4=100000$  ohms  $\pm 5$  per cent, 0.5 watt

(17-17)

### TWO-STAGE INPUT AMPLIFIER Cathode-Follower (Low-Impedance) Output

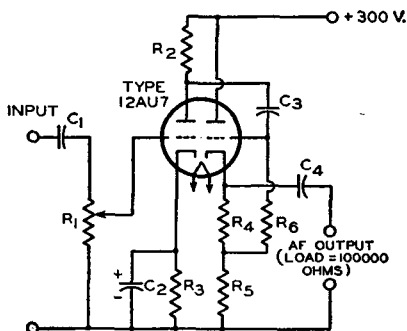

$C_1$   $C_2$  = 0.1  $\mu$ f, paper, 400 v.  
 $C_3$  = 25  $\mu$ f, electrolytic, 25 v.  
 $C_4$  = 5  $\mu$ f, paper, 200 v.

$R_1$  = Volume control, potentiometer, 500000 ohms  
 $R_2$  = 220000 ohms, 0.5 watt

$R_3$   $R_4$  = 5600 ohms, 0.5 watt  
 $R_5$  = 27000 ohms, 0.5 watt  
 $R_6$  = 560000 ohms, 0.5 watt

(17-18)

### BASS AND TREBLE TONE-CONTROL AMPLIFIER STAGE

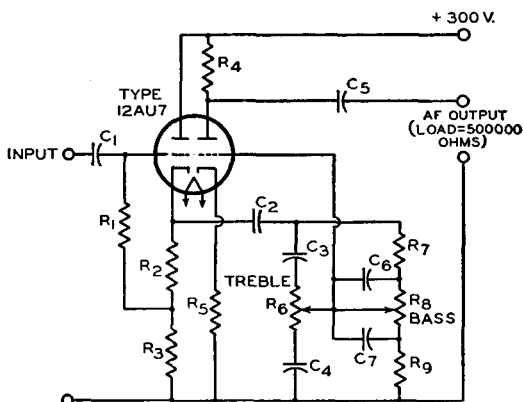

$C_1$  = 0.01  $\mu$ f, paper, 400 v.  
 $C_2$  = 0.02  $\mu$ f, paper, 200 v.  
 $C_3$  = 470  $\mu$ f, mica, 200 v.  
 $C_4$  = 0.005  $\mu$ f, mica, 200 v.  
 $C_5$  = 0.05  $\mu$ f, paper, 400 v.  
 $C_6$  = 0.001  $\mu$ f, paper, 200 v.

$C_7$  = 0.01  $\mu$ f, paper, 400 v.  
 $R_1$  = 560000 ohms, 0.5 watt  
 $R_2$  = 2200 ohms, 0.5 watt  
 $R_3$   $R_4$  = 220000 ohms, 0.5 watt  
 $R_5$  = 5600 ohms, 0.5 watt  
 $R_6$   $R_7$  = Tone control, potentiometer, 1 megohm, audio taper (10 per cent of total resistance at 50 per cent rotation)  
 $R_8$  = 22000 ohms, 0.5 watt  
 $R_9$  = 220000 ohms, 2 watts

ometer, 1 megohm, audio taper (10 per cent of total resistance at 50 per cent rotation)  
 $R_7$  = 22000 ohms, 0.5 watt  
 $R_9$  = 220000 ohms, 2 watts

(17-19)

### NON-MOTORBOATING RESISTANCE-COUPLED AMPLIFIER

Voltage Gain, 9000

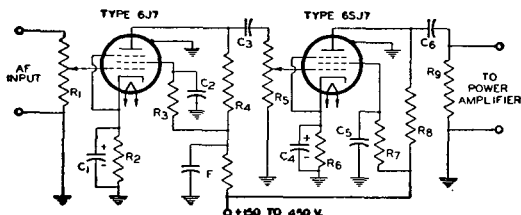

$C_1$   $C_4 = 8 \mu\text{f}$ , electrolytic, 25 v.  
 $C_2$   $C_5 = 0.06 \mu\text{f}$ , paper, voltage rating as high as supply voltage  
 $C_3$   $C_6 = 0.006 \mu\text{f}$ , paper, voltage rating as high as supply voltage

$R_1 =$  Volume control, potentiometer  
 $R_2$   $R_6 = 600$  ohms, 0.5 watt  
 $R_3$   $R_7$   $R_9 = 50000$  ohms, 0.5 watt

$R_4$   $R_8 = 100000$  ohms, 0.5 watt  
 $R_5 =$  Volume control, potentiometer, 0.5 megohm, ganged with  $R_1$   
 $F =$  Decoupling filter

NOTE: Values of resistance and capacitance shown in this circuit are taken from Charts 14 and 19 in the RESISTANCE-COUPLED AMPLIFIER SECTION. The values are chosen to give a sharp low-frequency cutoff and, thus, to minimize tendency of multiple stages to motorboat. Operation of three or more stages, including power stage, from a common B supply may make it necessary to use a decoupling filter in the plate-supply lead of one or more of the voltage amplifier stages. The constants of decoupling filters depend on the design requirements of the amplifier.

(17-20)

### CODE-PRACTICE OSCILLATOR

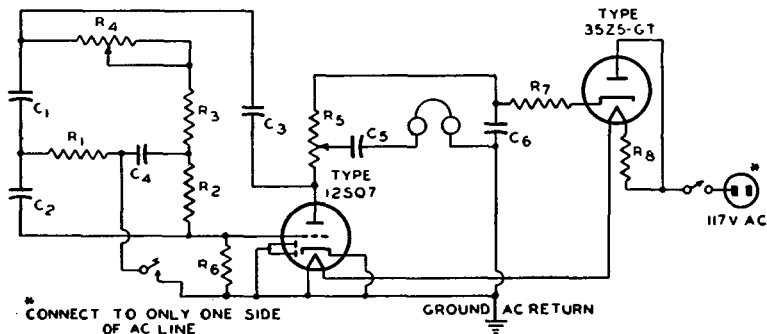

$C_1$   $C_2 = 0.001 \mu\text{f}$ , mica, 300 v.  
 $C_3 = 0.01 \mu\text{f}$ , paper, 400 v.  
 $C_4 = 0.002 \mu\text{f}$ , mica, 300 v.  
 $C_5 = 0.003 \mu\text{f}$ , paper, 400 v.  
 $C_6 = 20 \mu\text{f}$ , electrolytic, 250 v.

$R_1 = 27000$  ohms, 0.5 watt  
 $R_2 = 270000$  ohms, 0.5 watt  
 $R_3 = 220000$  ohms, 0.5 watt  
 $R_4 =$  Pitch-control, potentiometer, 1.0 megohm

$R_5 =$  Volume control, potentiometer, 100000 ohms  
 $R_6 = 2.2$  megohms, 0.5 watt  
 $R_7 = 47000$  ohms, 0.5 watt  
 $R_8 = 470$  ohms, 25 watts

NOTES: (1) The point marked "GROUND AC RETURN" should be connected to a cold-water pipe or other conductor providing a direct, low-resistance return to ground.

(2) High-impedance (2000 ohms or more) headphones are required.

(3) RCA miniature types 12AV6 and 35W4 may be substituted for the 12SQ7 and 35Z5-GT respectively without affecting performance of the circuit.



(17-21)

## INTERCOMMUNICATION SET

### With Master Unit and Six Remote Units

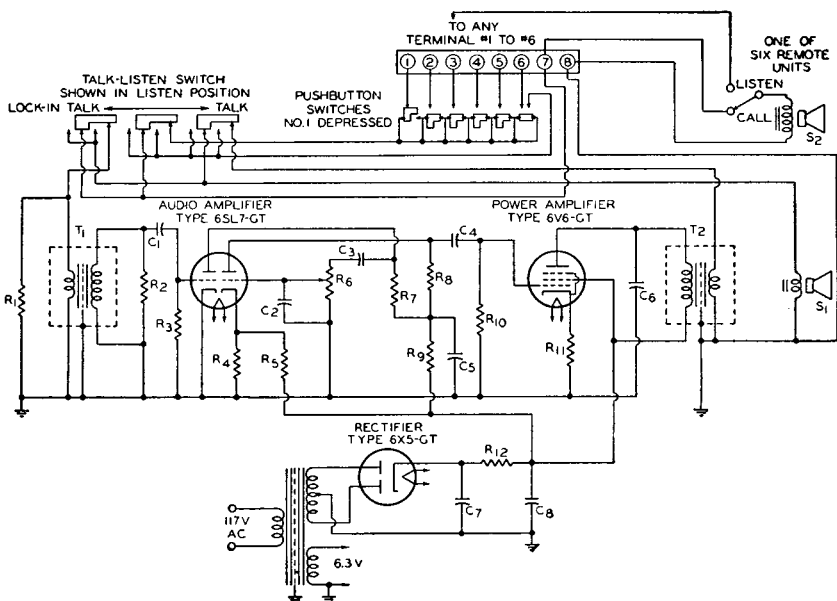

**C<sub>1</sub>** = 0.0025  $\mu$ f, paper, 400 v.  
**C<sub>2</sub>** = 470  $\mu$ f, ceramic or mica, 500 v.  
**C<sub>3</sub>** = 330  $\mu$ f, ceramic or mica, 500 v.  
**C<sub>4</sub>** = 0.01  $\mu$ f, paper, 600 v.  
**C<sub>5</sub>** = 0.1  $\mu$ f, paper, 400 v.  
**C<sub>6</sub>** = 5600  $\mu$ f, ceramic or mica, 500 v.  
**C<sub>7</sub>** **C<sub>8</sub>** = 20  $\mu$ f, electrolytic, 350 v.  
**R<sub>1</sub>** = 12 ohms, 0.5 watt  
**R<sub>2</sub>** = 470000 ohms, 0.5 watt

**R<sub>3</sub>** = 10 megohms, 0.5 watt  
**R<sub>4</sub>** = 330 ohms, 0.5 watt  
**R<sub>5</sub>** = 56000 ohms, 0.5 watt  
**R<sub>6</sub>** = Volume control, potentiometer, 500000 ohms  
**R<sub>7</sub>** **R<sub>8</sub>** **R<sub>10</sub>** = 330000 ohms, 0.5 watt  
**R<sub>9</sub>** = 82000 ohms, 0.5 watt  
**R<sub>11</sub>** = 270 ohms, 2 watts  
**R<sub>12</sub>** = 470 ohms, 5 watts  
**S<sub>1</sub>** **S<sub>2</sub>** = Speakers, permanent-magnet, voice-coil impedance 13 ohms

**T<sub>1</sub>** = Input transformer for matching speaker voice-coil impedance to grid, primary to secondary turns ratio 1:47.5  
**T<sub>2</sub>** = Output transformer for matching speaker voice-coil impedance to 5000-ohm tube load  
**T<sub>3</sub>** = Power transformer, 190-0-190 volts rms, 50 ma.

(17-22)

ELECTRONIC VOLT-OHM METER

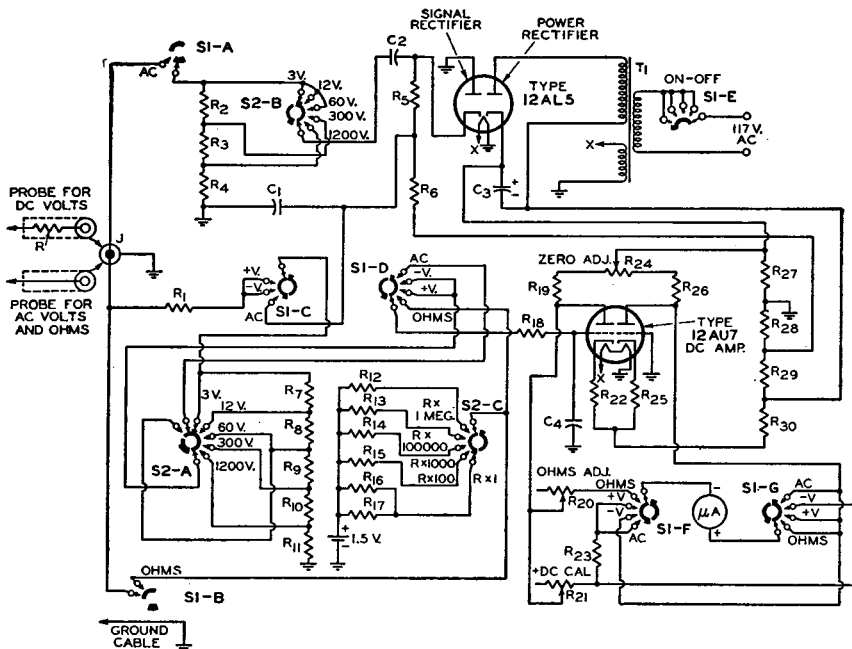

- C<sub>1</sub>=0.1 μf, paper, 200 v.
- C<sub>2</sub>=0.33 μf±10 per cent, paper, 400 v.
- C<sub>3</sub>=10 μf, electrolytic, 250 v.
- C<sub>4</sub>=0.01 μf, paper, 400 v.
- R=DC-voltage probe isolating resistor, 1 megohm±5 per cent, 0.5 watt
- R<sub>1</sub>=5 megohms±1 per cent, 0.5 watt
- R<sub>2</sub>=800000 ohms±1 per cent, 0.5 watt
- R<sub>3</sub>=1.36 megohms±1 per cent, 0.5 watt
- R<sub>4</sub>=250000 ohms±1 per cent, 0.5 watt
- R<sub>5</sub>=678000 ohms±1 per cent, 0.5 watt
- R<sub>6</sub>=361000 ohms±1 per cent, 0.5 watt
- R<sub>7</sub>=3.75 megohms±1 per cent, 0.5 watt
- R<sub>8</sub>=1 megohm±1 per cent, 0.5 watt

- R<sub>9</sub>=200000 ohms±1 per cent, 0.5 watt
- R<sub>10</sub>=37500 ohms±1 per cent, 0.5 watt
- R<sub>11</sub>=12500 ohms±1 per cent, 0.5 watt
- R<sub>12</sub>=10 megohms±5 per cent, 0.5 watt
- R<sub>13</sub> R<sub>18</sub>=1 megohm±5 per cent, 0.5 watt
- R<sub>14</sub>=10000 ohms±5 per cent, 0.5 watt
- R<sub>15</sub>=1000 ohms±5 per cent, 1 watt
- R<sub>16</sub>=10 ohms±5 per cent, 2 watts
- R<sub>17</sub>=330 ohms±5 per cent, 0.5 watt
- R<sub>19</sub>=15000 ohms±5 per cent, 0.5 watt
- R<sub>20</sub>=Potentiometer, 15000 ohms, 0.5 watt
- R<sub>21</sub>=Potentiometer, 7500 ohms, 0.5 watt

- R<sub>22</sub> R<sub>25</sub>=1500 ohms±5 per cent, 0.5 watt
- R<sub>23</sub>=470 ohms±5 per cent, 0.5 watt
- R<sub>24</sub>=Potentiometer, 12500 ohms, 0.5 watt
- R<sub>26</sub>=12000 ohms±5 per cent, 0.5 watt
- R<sub>27</sub>=47000 ohms±5 per cent, 0.5 watt
- R<sub>28</sub>=130 ohms±5 per cent, 0.5 watt
- R<sub>29</sub> R<sub>30</sub>=68000 ohms±5 per cent, 0.5 watt
- S<sub>1</sub>=Function-selector switch, 7-circuit, 5-position
- S<sub>2</sub>=Range-selector switch, 4-circuit, 5-position
- T<sub>1</sub>=Power transformer, 125 volts rms, 2.75 ma; 10 volts rms, 0.25 ampere
- μA=Meter, dc, 0-200 μamp

In the diagram the FUNCTION-SELECTOR SWITCH (S<sub>1</sub>) and RANGE-SELECTOR SWITCH (S<sub>2</sub>) are shown in their *maximum counterclockwise* positions (S<sub>1</sub>="OFF"; S<sub>2</sub>="3 VOLTS, R × 1")

NOTE: This electronic volt-ohm meter circuit, similar to those used in RCA VoltOhmyst†, is included here solely to illustrate a particular application of RCA Receiving Tubes. It is not recommended for home construction because of the large number of special components required, and because laboratory-type test equipment and reference standards are necessary for proper checking and calibration of the various functions and ranges.

† Trade Mark Reg. U. S. Pat. Off.

# Outlines

## METAL TUBES—Outlines 1-7

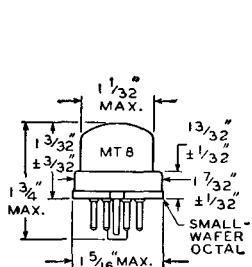

- 1 -

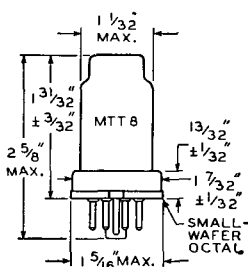

- 2 -

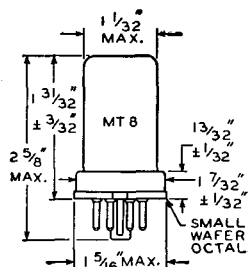

- 3 -

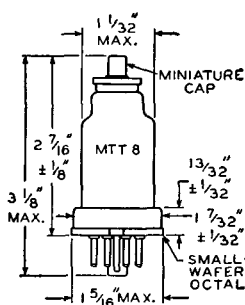

- 4 -

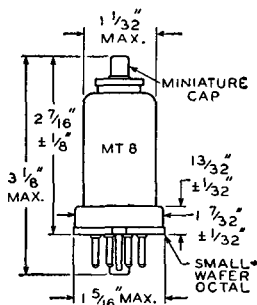

- 5 -

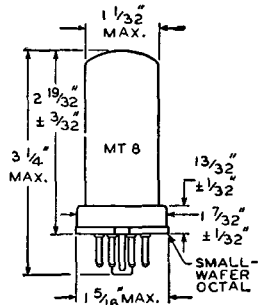

- 6 -

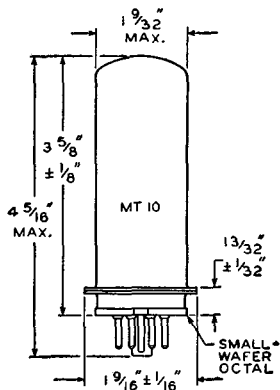

- 7 -

GLASS TUBES—Outlines 8-19

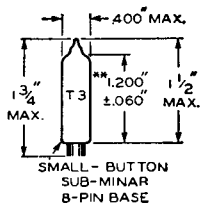

SMALL-BUTTON  
SUB-MINOR  
8-PIN BASE

-8-

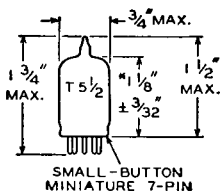

SMALL-BUTTON  
MINIATURE 7-PIN

-9-

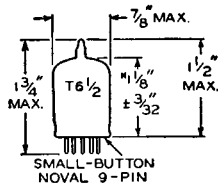

SMALL-BUTTON  
NOVAL 9-PIN

-10-

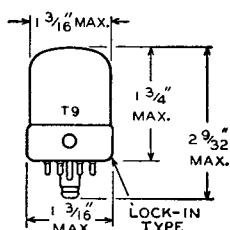

LOCK-IN  
TYPE

-11-

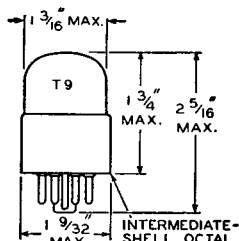

INTERMEDIATE-  
SHELL OCTAL

-12-

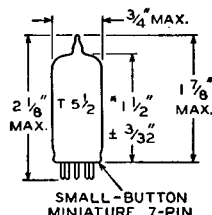

SMALL-BUTTON  
MINIATURE 7-PIN

-13-

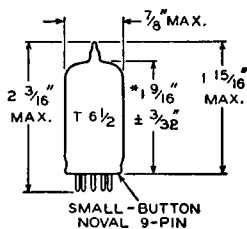

SMALL-BUTTON  
NOVAL 9-PIN

-14-

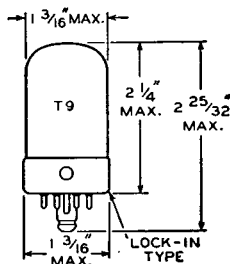

LOCK-IN  
TYPE

-15-

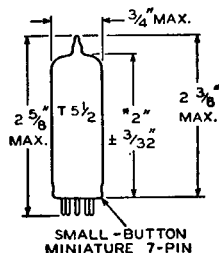

SMALL-BUTTON  
MINIATURE 7-PIN

-16-

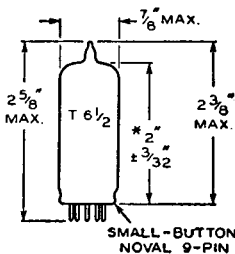

SMALL-BUTTON  
NOVAL 9-PIN

-17-

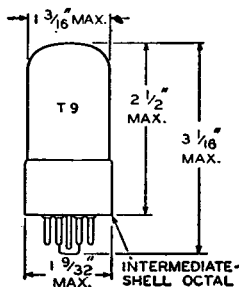

INTERMEDIATE-  
SHELL OCTAL

-18-

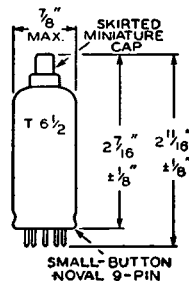

SMALL-BUTTON  
NOVAL 9-PIN

-19-

\* MEASURED FROM BASE SEAT TO BULB TOP LINE AS DETERMINED BY RING GAUGE OF 7/16" I.D.  
\*\* MEASURED FROM BASE SEAT TO BULB TOP LINE AS DETERMINED BY RING GAUGE OF 210" I.D.

GLASS TUBES—Outlines 20-28

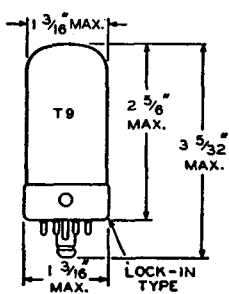

-20-

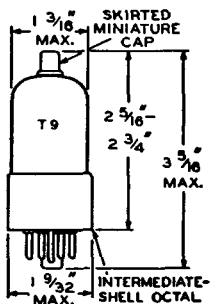

-21-

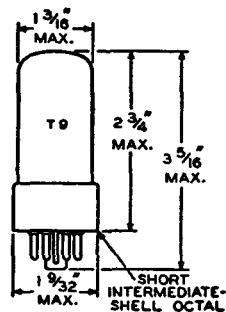

-22-

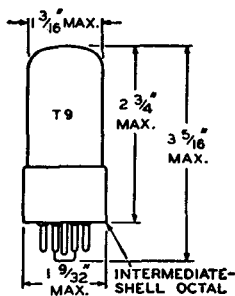

-23-

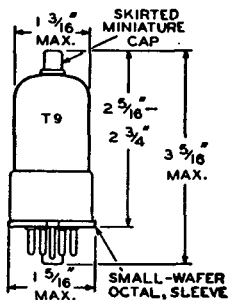

-24-

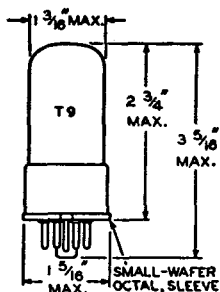

-25-

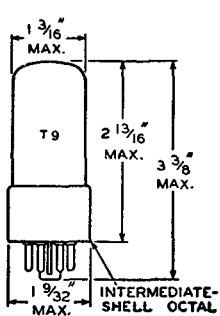

-26-

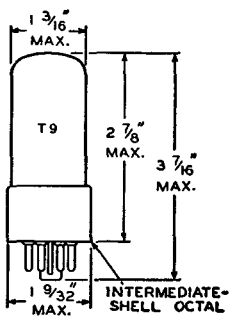

-27-

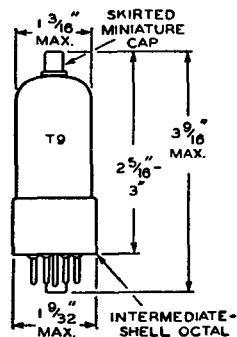

-28-

GLASS TUBES—Outlines 29-37

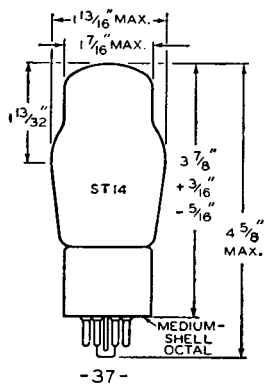
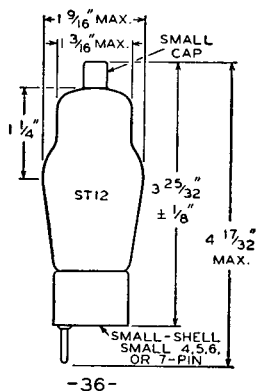
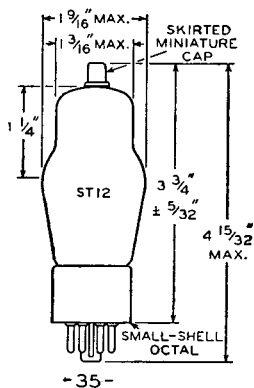
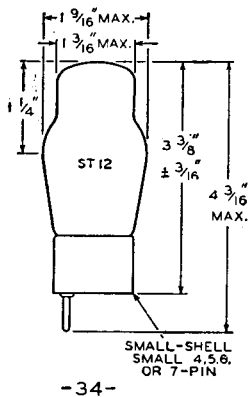
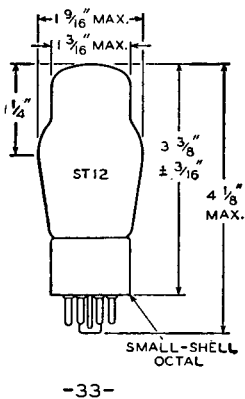
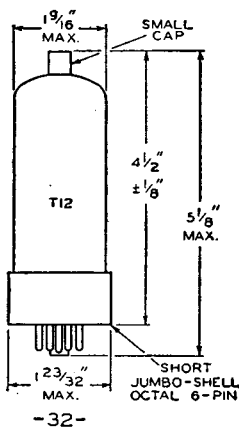
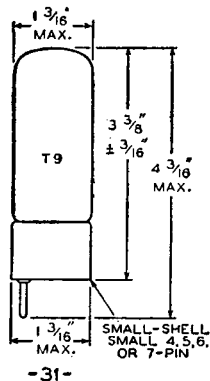
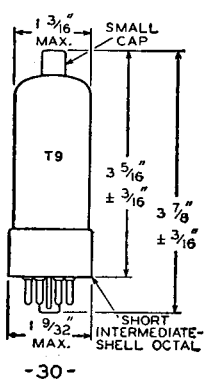
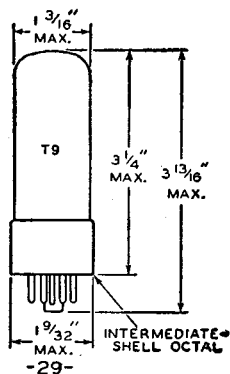

GLASS TUBES—Outlines 38-45

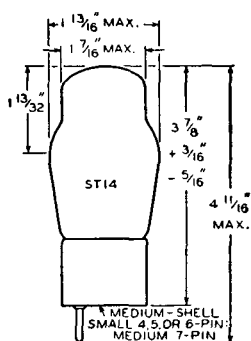

-38-

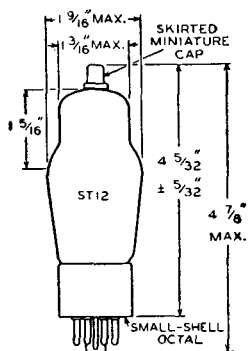

-39-

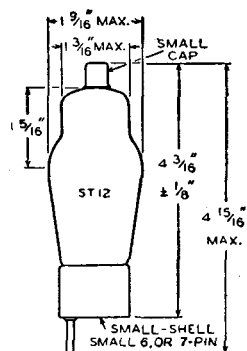

-40-

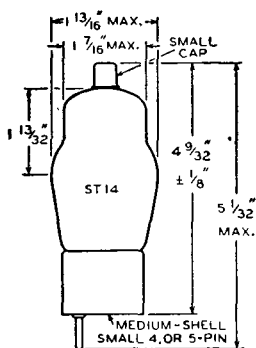

-41-

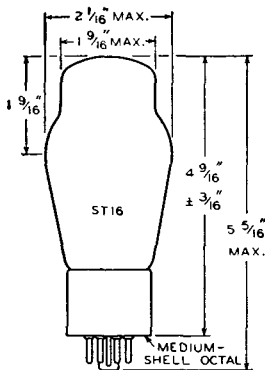

-42-

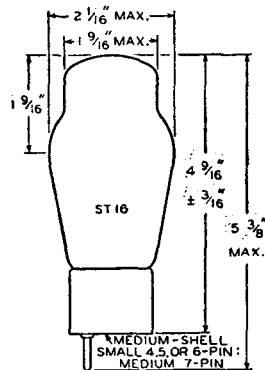

-43-

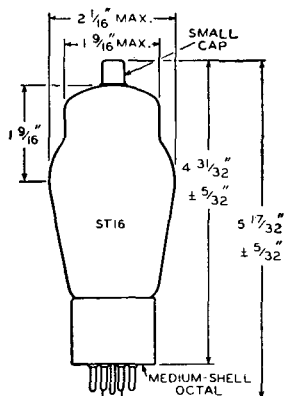

-44-

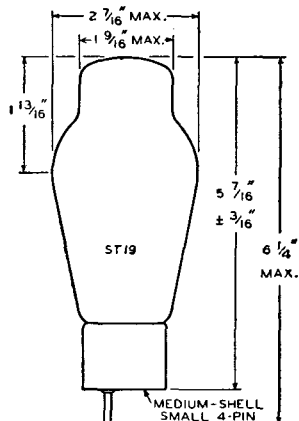

-45-





# INDEX

|   | <i>Page</i>    |   | <i>Page</i>       |
|---|----------------|---|-------------------|
| <b>A</b> dmittance, Input .....                 | 16             | peak inverse plate voltage .....                    | 60                |
| Amplification Factor ( $\mu$ ) .....            | 12             | plate efficiency .....                              | 13                |
| <b>A</b> mplifier:                              |                | plate resistance .....                              | 12                |
| audio-frequency .....                           | 14             | power output .....                                  | 18, 21, 24        |
| audio mixer, circuit .....                      | 283            | power sensitivity .....                             | 13                |
| cathode-drive .....                             | 27             | screen-voltage dropping resistor .....              | 64                |
| cathode-follower .....                          | 26, 29         | transconductance .....                              | 13, 30, 31        |
| cathode-follower, circuit .....                 | 285            | voltage amplification (gain) .....                  | 15, 29, 32        |
| class A .....                                   | 14, 17         | <b>C</b> apacitor-Input Filter .....                | 56                |
| class A <sub>1</sub> , circuit .....            | 281, 286       | <b>C</b> athode:                                    |                   |
| class AB .....                                  | 14, 22         | bias .....  | 52                |
| class AB <sub>1</sub> .....                     | 23             | bypassing .....                                     | 52                |
| class AB <sub>1</sub> , circuit .....           | 281, 282       | connection .....                                    | 51                |
| class AB <sub>2</sub> .....                     | 25             | current .....                                       | 52                |
| class B .....                                   | 14, 26         | directly heated .....                               | 4                 |
| class B, circuit .....                          | 283            | drive .....   | 27                |
| class C .....                                   | 14             | follower .....                                      | 26, 29, 285       |
| dc .....  | 44             | indirectly heated .....                             | 4                 |
| limiter .....                                   | 34, 41         | resistor .....                                      | 52                |
| low-distortion input, circuit .....             | 284            | types .....   | 3                 |
| parallel .....                                  | 17             | <b>C</b> haracteristic Curves, Interpretation of .. | 62                |
| phase-inverter .....                            | 33             | <b>C</b> haracteristics:                            |                   |
| preamplifier, circuit .....                     | 284            | amplification factor .....                          | 12                |
| push-pull .....                                 | 17, 20, 23, 26 | control-grid-plate transconductance .....           | 13                |
| radio-frequency .....                           | 14, 16         | conversion transconductance .....                   | 13                |
| remote-cutoff .....                             | 16, 45         | dynamic .....                                       | 12                |
| sharp-cutoff .....                              | 45             | plate resistance .....                              | 12                |
| tone control, circuit .....                     | 285            | static .....  | 12                |
| voltage .....                                   | 14             | <b>C</b> harts and Tables:                          |                   |
| volume-expander .....                           | 31             | kinescope characteristic chart .....                | 246               |
| <b>A</b> mplitude Modulation (AM) .....         | 37             | materials chart .....                               | 268               |
| <b>A</b> node .....                             | 5              | outline drawings .....                              | 289               |
| <b>A</b> node-Grid .....                        | 46             | parts of a miniature pentode .....                  | 2                 |
| <b>A</b> rc-Back Limit .....                    | 60             | preferred types list .....                          | Inside Back Cover |
| <b>A</b> utomatic Frequency Control (AFC) ..... | 48             | resistance-coupled amplifiers .....                 | 255               |
| <b>A</b> utomatic Volume Control (AVC) .....    | 42             | structure of a kinescope gun .....                  | 280               |
| <b>B</b> eam Power Tube Considerations .....    | 8              | structure of miniature tube .....                   | 68                |
| <b>B</b> ias:                                   |                | tube classification by use and by filament          |                   |
| battery .....                                   | 52             | or heater voltage .....                             | 66                |
| cathode (self) .....                            | 52             | tube-part materials .....                           | 65                |
| diode .....                                     | 39             | types not recommended for new                       |                   |
| grid-resistor .....                             | 39, 51, 52     | equipment design .....                              | Inside Back Cover |
| self (cathode) .....                            | 52             | <b>C</b> hoke-Input Filter .....                    | 56                |
| <b>C</b> alculation of:                         |                | <b>C</b> ircuit Diagram of:                         |                   |
| amplification factor .....                      | 12             | ac/dc superheterodyne receiver (17-4) ..            | 273               |
| cathode (self-bias) resistor .....              | 52             | ac-operated superheterodyne receiver                |                   |
| cathode load resistor .....                     | 30             | (17-3) .....  | 272               |
| control-grid-plate transconductance .....       | 13             | audio mixer (17-14) .....                           | 283               |
| filament resistor power dissipation .....       | 50             | automobile receiver (17-5) .....                    | 274               |
| filament (or heater) resistor value .....       | 49             | bass and treble tone-control amplifier              |                   |
| harmonic distortion .....                       | 19, 20, 22, 25 | stage (17-18) .....                                 | 285               |
| load resistance .....                           | 20, 21, 24     | battery-operated short-wave receiver                |                   |
| operating conditions from conversion            |                | (17-7) .....  | 276               |
| curves .....                                    | 22             | class B amplifier for mobile use (17-13) ..         | 283               |
|   |                | code practice oscillator (17-20) .....              | 286               |
|   |                | electronic volt-ohm meter (17-22) .....             | 288               |
|   |                | FM tuner (17-9) .....                               | 278               |

# INDEX (Continued)

|  | <i>Page</i> |   | <i>Page</i> |
|--|-------------|---|-------------|
| high-fidelity audio amplifier            |             | Dress of Circuit Leads                    | 55          |
| class AB <sub>1</sub> —10 watts (17-11)  | 281         | Driver                                    | 17, 23, 26  |
| high-power audio amplifier:              |             | Dynamic Characteristics                   | 12          |
| class AB <sub>1</sub> —25 watts (17-12)  | 282         | <b>E</b> lectron:                         |             |
| intercommunication set (17-21)           | 287         | considerations                            | 3           |
| low-distortion input amplifier           |             | secondary                                 | 8, 9        |
| stage (17-16)                            | 284         | Electron Tube Applications                | 14          |
| microphone and phonograph amplifier—     |             | Electron Tube Characteristics             | 12          |
| 6 watts (17-10)                          | 280         | Electron Tube Installation                | 49          |
| non-motorboating resistance-coupled      |             | Electron Tube Testing                     | 251         |
| amplifier (17-19)                        | 286         | Electrons, Electrodes, and Electron Tubes | 3           |
| portable superheterodyne receiver        |             | Electron-Ray Tubes                        | 44          |
| (17-1)                                   | 270         | Emission:                                 |             |
| portable 3-way superheterodyne           |             | current                                   | 5           |
| receiver (17-2)                          | 271         | secondary                                 | 8, 9        |
| preamplifier for magnetic phonograph     |             | test                                      | 252         |
| pickup (17-15)                           | 284         | <b>F</b> eedback:                         |             |
| superregenerative receiver (17-6)        | 275         | inverse                                   | 27          |
| TRF AM tuner (17-8)                      | 277         | undesired                                 | 55          |
| two-stage input amplifier, cathode-fol-  |             | Filament (also see Heater and Cathode):   |             |
| lower (low-impedance) output (17-17)     | 285         | operation                                 | 3, 49       |
| Contact Potential                        | 54          | resistor                                  | 49          |
| Conversion Curves, Use of                | 22          | series operation                          | 50          |
| Conversion Transconductance              | 13          | shunt resistor                            | 51          |
| Corrective Filter                        | 32          | supply voltage                            | 49          |
| Cross-Modulation                         | 16, 53      | Filter:                                   |             |
| Current:                                 |             | capacitor-input                           | 56          |
| cathode                                  | 52          | choke-input                               | 56          |
| dc output                                | 61          | corrective                                | 32          |
| grid                                     | 14, 23      | radio-frequency                           | 56          |
| peak plate                               | 62          | smoothing                                 | 56          |
| plate                                    | 5           | Formulas (see Calculation)                |             |
| Curves, Interpretation of Characteristic | 62          | Frequency Conversion                      | 46          |
| Cutoff                                   | 16          | Frequency Modulation (FM)                 | 37, 40      |
| <b>D</b> C Amplifier                     | 44          | Full-Wave Diode Detection                 | 38          |
| Degeneration (See Inverse Feedback)      |             | Full-Wave Rectifier                       | 5, 35       |
| Delayed Automatic Volume Control         |             | Fuses, Use of                             | 51          |
| (DAVC)                                   | 43          | <b>G</b> ain (Voltage Amplification)      | 15          |
| Demodulation                             | 37          | Grid:                                     |             |
| Design-Center System of Ratings          | 62          | anode                                     | 46          |
| Detection:                               |             | bias                                      | 52          |
| diode                                    | 37          | bias detection                            | 39          |
| discriminator                            | 40          | considerations                            | 6           |
| full-wave diode                          | 38          | current                                   | 14, 23      |
| grid bias                                | 39          | resistor                                  | 15, 52      |
| grid-resistor and capacitor              | 39          | resistor and capacitor detection          | 39          |
| ratio detector                           | 41          | voltage supply                            | 51          |
| Diode:                                   |             | Grid-Plate Capacitance                    | 7           |
| biasing                                  | 39          | Grid-Plate Transconductance               | 13          |
| considerations                           | 5           |   |             |
| detection                                | 37          |   |             |
| load resistor                            | 38          |   |             |
| Discriminator                            | 40          |   |             |

# INDEX (Continued)

|  | <i>Page</i>        |
|--|--------------------|
| <b>Half-Wave Rectifier</b> .....                 | 5, 35              |
| <b>Harmonic Distortion</b> .....                 | 19, 20, 22, 25     |
| <b>Heater:</b>                                   |                    |
| cathode.....                                     | 4                  |
| cathode bias.....                                | 52                 |
| cathode connection.....                          | 51                 |
| resistor.....                                    | 52                 |
| series operation.....                            | 50                 |
| shunt resistor.....                              | 51                 |
| supply voltage.....                              | 49                 |
| <b>Hexode Mixer</b> .....                        | 47                 |
| <b>Impedance, Input</b> .....                    | 16                 |
| <b>Input Capacitance</b> .....                   | 62                 |
| <b>Instantaneous Peak Voltage</b> .....          | 57                 |
| <b>Interelectrode Capacitances</b> .....         | 7, 62              |
| <b>Intermediate Frequency, Production of</b> ... | 46                 |
| <b>Interpretation of Tube Data</b> .....         | 60                 |
| <b>Inverse Feedback:</b>                         |                    |
| constant-current type.....                       | 27, 29             |
| constant-voltage type.....                       | 27                 |
| <b>Key to Socket Connection</b>                  |                    |
| Diagrams.....                                    | Inside Front Cover |
| <b>Kinescope:</b>                                |                    |
| basing diagrams.....                             | 248                |
| characteristics chart.....                       | 246                |
| corona considerations.....                       | 58                 |
| deflection.....                                  | 11                 |
| dust considerations.....                         | 58                 |
| essential elements.....                          | 10                 |
| handling precautions.....                        | 59                 |
| high-voltage considerations.....                 | 58                 |
| humidity considerations.....                     | 58                 |
| safety considerations.....                       | 59                 |
| screen.....                                      | 11                 |
| structure.....                                   | 10, 11, 250        |
| x-ray radiation precautions.....                 | 59                 |
| <b>Kinescope Gun Structure</b> .....             | 250                |
| <b>Limiters</b> .....                            | 34, 41             |
| <b>Load:</b>                                     |                    |
| resistance.....                                  | 20, 21, 24         |
| resistance line.....                             | 18, 20, 21, 23     |
| <b>Low-Distortion Input Amplifier Stage</b> .... | 284                |
| <b>Materials Chart</b> .....                     | 268                |
| <b>Mercury-Vapor Rectifier:</b>                  |                    |
| considerations.....                              | 6                  |
| interference from.....                           | 57                 |
| <b>Mho</b> .....                                 | 13                 |
| <b>Micromho</b> .....                            | 13                 |
| <b>Miniature Tube, Structure of</b> .....        | 68                 |
| <b>Mixer:</b>                                    |                    |
| audio.....                                       | 283                |
| hexode.....                                      | 47                 |
| pentagrid.....                                   | 48                 |
| <b>Modulated Wave</b> .....                      | 37, 40             |
| <b>Modulation</b> .....                          | 37                 |
| <b>Modulation-Distortion</b> .....               | 16, 53             |
| <b>Multi-Electrode Tube</b> .....                | 9                  |
| <b>Multi-Unit Tubes</b> .....                    | 9                  |
| <b>Multivibrator</b> .....                       | 45                 |
| <b>Mutual Conductance</b>                        |                    |
| (see Transconductance)                           |                    |
| <b>Oscillator:</b>                               |                    |
| considerations.....                              | 45                 |
| multivibrator.....                               | 45                 |
| relaxation.....                                  | 45                 |
| <b>Outlines of Tubes</b> .....                   | 289                |
| <b>Output Capacitance</b> .....                  | 62                 |
| <b>Output-Coupling Devices</b> .....             | 57                 |
| <b>Parallel Operation</b> .....                  | 17                 |
| <b>Parasitic Oscillations</b> .....              | 18                 |
| <b>Parts of a Miniature Pentode</b> .....        | 2                  |
| <b>Peak Inverse Plate Voltage</b> .....          | 60                 |
| <b>Peak Plate Current</b> .....                  | 62                 |
| <b>Pentagrid Converter</b> .....                 | 9, 46              |
| <b>Pentagrid Mixer</b> .....                     | 33, 48             |
| <b>Pentode Considerations</b> .....              | 8                  |
| <b>Phase Inverter</b> .....                      | 33, 257            |
| <b>Plate:</b>                                    |                    |
| current.....                                     | 5                  |
| dissipation.....                                 | 60                 |
| efficiency.....                                  | 13                 |
| load.....  | 20, 21, 24         |
| resistance.....                                  | 12                 |
| voltage supply.....                              | 51                 |
| <b>Plate-Cathode Capacitance</b> .....           | 7, 62              |
| <b>Power Output:</b>                             |                    |
| calculations.....                                | 18, 21, 24         |
| test.....  | 253                |
| <b>Power Sensitivity</b> .....                   | 13                 |
| <b>Power Supply</b> .....                        | 52                 |
| <b>Preamplifier for Magnetic Phonograph</b>      |                    |
| Pickup.....                                      | 284                |
| <b>Preferred Types List</b> .....                | Inside Back Cover  |
| <b>Push-Pull Operation</b> .....                 | 17, 20, 23, 26     |

# INDEX (Continued)

|  | <i>Page</i>        |  | <i>Page</i> |
|--|--------------------|--|-------------|
| <b>Radio-Frequency:</b>                              |                    | <b>Symbols Used in Resistance-Coupled</b>      |             |
| amplifier . . . . .                                  | 14, 16             | Amplifier Charts . . . . .                     | 256         |
| filter . . . . .                                     | 56                 | <b>Tables and Charts:</b>                      |             |
| <b>Ratings, Design-Center System . . . . .</b>       | <b>62</b>          | (see Charts and Tables)                        |             |
| <b>Ratio Detector . . . . .</b>                      | <b>41</b>          | <b>Technical Data for Tube Types . . . . .</b> | <b>69</b>   |
| <b>Reading List . . . . .</b>                        | <b>320</b>         | <b>Testing Electron Tubes . . . . .</b>        | <b>251</b>  |
| <b>Receiving Tube Classification Chart . . . . .</b> | <b>66</b>          | <b>Tetrode Considerations . . . . .</b>        | <b>7</b>    |
| <b>Rectifiers:</b>                                   |                    | <b>Tone-Control Amplifier Stage . . . . .</b>  | <b>285</b>  |
| full-wave . . . . .                                  | 5, 35              | <b>Transconductance:</b>                       |             |
| half-wave . . . . .                                  | 5, 35              | conversion . . . . .                           | 13          |
| ionic-heated cathode . . . . .                       | 6                  | grid-plate . . . . .                           | 13          |
| parallel operation of . . . . .                      | 35                 | test . . . . .                                 | 252         |
| plate characteristics curves . . . . .               | 61                 | <b>Triode Considerations . . . . .</b>         | <b>6</b>    |
| voltage doubler . . . . .                            | 36                 | <b>Tube:</b>                                   |             |
| <b>Relaxation Oscillator . . . . .</b>               | <b>45</b>          | materials chart . . . . .                      | 268         |
| <b>Remote-Cutoff Tubes . . . . .</b>                 | <b>16, 45</b>      | outlines . . . . .                             | 289         |
| <b>Resistance Coupling . . . . .</b>                 | <b>33</b>          | parts of miniature . . . . .                   | 2           |
| <b>Resistance-Coupled Amplifier . . . . .</b>        | <b>15, 29, 255</b> | ratings, interpretation of . . . . .           | 60          |
| <b>Resistor:</b>                                     |                    | structure of a kinescope gun . . . . .         | 250         |
| cathode (self-biasing) . . . . .                     | 52                 | structure of miniature . . . . .               | 68          |
| center tap . . . . .                                 | 52                 | tester requirements . . . . .                  | 254         |
| filament . . . . .                                   | 49                 | <b>Tube Types:</b>                             |             |
| filter . . . . .                                     | 56                 | technical data . . . . .                       | 69          |
| grid . . . . .                                       | 15                 | <b>Tuning Indicators . . . . .</b>             | <b>44</b>   |
| plate load . . . . .                                 | 20, 21, 24         | <b>Twin Diode:</b>                             |             |
| screen . . . . .                                     | 54, 64             | pentode . . . . .                              | 10          |
| <b>Saturation Current . . . . .</b>                  | <b>5</b>           | triode . . . . .                               | 10, 38      |
| <b>Screen (Grid No. 2):</b>                          |                    | <b>Typical Operation Values,</b>               |             |
| considerations . . . . .                             | 7                  | Interpretation of . . . . .                    | 62          |
| input . . . . .                                      | 60, 64             | <b>Voltage:</b>                                |             |
| voltage supply . . . . .                             | 54                 | amplification, class A . . . . .               | 14          |
| <b>Secondary Emission . . . . .</b>                  | <b>8</b>           | doubler rectifier . . . . .                    | 36          |
| <b>Secondary Electrons . . . . .</b>                 | <b>8, 9</b>        | peak heater-cathode . . . . .                  | 60          |
| <b>Self-bias (cathode bias) . . . . .</b>            | <b>52</b>          | peak inverse plate . . . . .                   | 60          |
| <b>Shielding . . . . .</b>                           | <b>55</b>          | supply . . . . .                               | 49          |
| <b>Short-Circuit Test . . . . .</b>                  | <b>251</b>         | <b>Voltage Conversion Factor . . . . .</b>     | <b>23</b>   |
| <b>Socket Connection Diagrams,</b>                   |                    | <b>Voltage Doubler . . . . .</b>               | <b>36</b>   |
| Key to . . . . .                                     | Inside Front Cover | <b>Volume Control:</b>                         |             |
| <b>Space Charge . . . . .</b>                        | <b>5, 9</b>        | automatic (AVC) . . . . .                      | 42          |
| <b>Static Characteristics . . . . .</b>              | <b>12</b>          | by grid-voltage variation . . . . .            | 53          |
| <b>Structure of a Miniature Tube . . . . .</b>       | <b>68</b>          | by screen-voltage variation . . . . .          | 55          |
| <b>Suppressor (Grid No. 3) . . . . .</b>             | <b>8</b>           | delayed automatic (DAVC) . . . . .             | 43          |
|  |                    | <b>Volume Expander . . . . .</b>               | <b>31</b>   |
|  |                    | <b>Zero-Bias Operation . . . . .</b>           | <b>52</b>   |

*Notes:*

*Notes:*

*Notes:*

*Notes:*



*Notes:*

*Notes:*

**Notes:**

*Notes:*

*Notes:*

*Notes:*

**Notes:**

*Notes:*



*Notes:*

*Notes:*

*Notes:*

*Notes:*

*Notes:*

# RCA Tube Division

## Technical Publications

Copies of the publications listed below may be obtained from your RCA Tube Distributor, or direct from Commercial Engineering, Tube Division, Radio Corporation of America, Harrison, New Jersey.

### Electron Tubes

- **TUBE HANDBOOK—ALL TYPES HB-3** ( $7\frac{3}{8}'' \times 5''$ ). The bible of the industry—contains over 3000 pages of loose-leaf data and curves on all RCA receiving tubes including kinescopes, power tubes, cathode-ray tubes, phototubes, and special tubes. Four deluxe 4-prong binders imprinted in gold. Available on subscription basis. Price \$13.50\* including service for first year. Write to Commercial Engineering for descriptive folder and order form.
- **RECEIVING TUBE MANUAL—RC-17** ( $8\frac{3}{8}'' \times 5\frac{3}{8}''$ )—320 pages. Supersedes RC-16. Revised, expanded, and brought up to date. Contains the latest receiving tubes, including types for black-and-white and color television applications. Features tube theory written for the layman, application data, Resistance-Coupled Amplifier Section, and several new circuits for high-fidelity audio amplifiers. Features lie-flat binding. Price 60 cents.\*
- **PHOTOTUBES BOOKLET—PT-20R1** ( $10\frac{7}{8}'' \times 8\frac{3}{8}''$ )—16 pages. Phototube theory, data on 15 types, curves and circuits for light-operated relays, light measurements, and sound reproduction. Single copy free on request.
- **RADIOTRON† DESIGNER'S HANDBOOK**—4th Edition ( $8\frac{3}{4}'' \times 5\frac{1}{2}''$ )—1500 pages. New enlarged up-to-date 4th edition is comprehensive reference thoroughly covering the design of radio and audio circuits and equipment. Written for the design engineer, student, and experimenter. Contains 1000 illustrations, 2500 references, and cross-referenced index of 7000 entries. Edited by F. Langford-Smith of Amalgamated Wireless Valve Co., Pty., Ltd. in Australia. Price \$7.00.\*
- **POWER AND GAS TUBES FOR RADIO AND INDUSTRY**—Bulletin PG-101-A ( $10\frac{7}{8}'' \times 8\frac{3}{8}''$ )—20 pages. Technical information on more than 160 RCA vacuum power tubes, rectifier tubes, thyratrons, ignitrons, and voltage regulators. Includes terminal connections. Price 15 cents.\*
- **PHOTOTUBES, CATHODE-RAY AND SPECIAL TUBES**—Bulletin CRPS-102-A ( $10\frac{7}{8}'' \times 8\frac{3}{8}''$ )—20 pages. Completely revised and brought up to date. Technical information on 150 single-unit, twin-unit, and multiplier phototubes, cathode-ray tubes, camera tubes, monoscopes, and types for special applications. Includes terminal connection diagrams. Price 15 cents.\*
- **RECEIVING TUBES FOR AM, FM, AND TELEVISION BROADCAST**—Bulletin 1275-F ( $10\frac{7}{8}'' \times 8\frac{3}{8}''$ )—24 pages. Completely revised and brought up to date. Contains characteristics of more than 495 RCA receiving tubes including kinescopes. Socket connection diagrams arranged for quick and easy reference. Price 15 cents.\*
- **INSTRUCTION BOOKLETS**—Complete authorized information on RCA transmitting tubes and other tubes for communications and industry. Be sure to mention tube-type booklet desired. Single copy on any type free on request.
- **AIR-COOLED TRANSMITTING TUBES MANUAL—TT3** ( $8\frac{3}{8}'' \times 5\frac{3}{8}''$ )—192 pages. Published several years ago, this book still retains popularity for instruction purposes. It contains basic information on generic tube types, tube parts and materials, tube ratings, tube installation and application, transmitter-design considerations, rectifiers and filters, as well as data on many of the older tube types. Price 35 cents.\*

\*Prices shown apply in U.S.A. and are subject to change without notice.

†Trade Mark Reg. U. S. Pat. Off.

- **HEADLINERS FOR HAMS**—Bulletin HAM-103A (10 $\frac{7}{8}$ " x 8 $\frac{3}{8}$ ")—4 pages. Technical information and terminal connection diagrams for 30 RCA "HAM" PREFERENCE TYPES: class B modulators, class C amplifiers and oscillators, frequency multipliers, rectifier tubes, thyatrons, and cold-cathode (glow-discharge) tubes. Single copy free on request.
- **TUBE PICTURE BOOK**—Bulletin TPB-1 (10 $\frac{7}{8}$ " x 8 $\frac{3}{8}$ ")—16 pages. Collection of photographs and cutaway drawings of representative tube types. Prepared especially for use by students. A visual aid for the details of tube construction. Price 25 cents.\*
- **RCA PREFERRED TYPES LIST**—Bulletin PTL-501-D (10 $\frac{7}{8}$ " x 8 $\frac{3}{8}$ ")—4 pages. Lists RCA Preferred Tube Types, both receiving and non-receiving, by function. An aid to equipment designers in the selection of tube types for new equipment design. Single copy free on request.
- **RCA INTERCHANGEABILITY DIRECTORY ON TUBES FOR COMMUNICATIONS AND INDUSTRY**—Bulletin ID-1020 (10 $\frac{7}{8}$ " x 8 $\frac{3}{8}$ ")—20 pages. Lists 1600 type designations of 24 different manufacturers arranged in alphabetical-numerical sequence; shows the RCA Direct Replacement Type or the RCA Similar Type. Price 15 cents.\*
- **RCA KINESCOPES**—Bulletin KB-1022 (10 $\frac{7}{8}$ " x 8 $\frac{3}{8}$ ")—20 pages. Characteristics and basing diagrams for RCA's complete line of kinescopes. Includes interchangeability directory and features a conversion chart helpful in modifying television receivers for larger kinescopes. Price 25 cents.\*
- **RCA POWER-TUBE FITTINGS**—Bulletin PTF-1012-A (10 $\frac{7}{8}$ " x 8 $\frac{3}{8}$ ")—24 pages. Lists 39 power-tube fittings designed for supporting and cooling power tubes, and illustrates their use with power tubes made by RCA and other manufacturers. Includes exploded-view assembly drawings as well as detail drawings of all fittings. Price 25 cents.\*

## Semiconductor Devices

- **RCA TRANSISTORS**—Bulletin SCD-104 (10 $\frac{7}{8}$ " x 8 $\frac{3}{8}$ ")—8 pages. This new bulletin gives technical information on RCA transistors—2N32 and 2N33 point-contact types, and 2N34 junction type. Bulletin also includes general information on transistor considerations, characteristics, and operation. Single copy free on request.
- **RCA CRYSTAL DIODES**—Instruction booklets containing technical information on crystal diodes of the germanium point-contact type—general-purpose type 1N34-A, high-back-resistance type 1N54-A, high-conduction type 1N56-A, and large-signal types 1N38-A, 1N55-A, and 1N58-A. Booklets include diode characteristics and performance curves. Single copy free on request.

## Components and Service Parts

- **RCA VICTOR SERVICE DATA**—Cover RCA Victor radios, phonographs, and television receivers of 1923 through 1952. Material includes schematic and wiring diagrams, electrical and mechanical specifications, alignment and adjustment procedures, complete service parts lists, chassis layouts, and much other useful servicing data. This material is available in eight bound volumes covering the years 1923 through 1952.

### BOUND VOLUMES—RADIO, PHONOGRAPH, TELEVISION

| Volume No. | Years        | Pages | Price* |
|------------|--------------|-------|--------|
| I          | 1923 to 1937 | 880   | \$3.50 |
| II         | 1938 to 1942 | 816   | \$4.00 |
| III        | 1943 to 1946 | 290   | \$4.00 |
| IV         | 1947 to 1948 | 566   | \$6.00 |
| V          | 1949         | 330   | \$5.00 |
| VI         | 1950         | 472   | \$5.50 |
| VII        | 1951         | 304   | \$5.00 |
| VIII       | 1952         | 314   | \$5.00 |

- **SERVICE PARTS DIRECTORY FOR RCA VICTOR TV RECEIVERS—SP-1007** (10 $\frac{7}{8}$ " x 16 $\frac{3}{4}$ ")—80 pages. Schematic diagrams and replacement parts lists for all RCA Victor television receivers manufactured from 1946 through June 1950 (56 models). Large-size book opens so that schematic diagrams face corresponding parts lists for quick reference. Price 75 cents.\*
- **SERVICE PARTS DIRECTORY FOR RCA VICTOR TV RECEIVERS—SP-1014** (10 $\frac{7}{8}$ " x 8 $\frac{3}{8}$ ") 142 pages. Schematic diagrams, replacement parts lists, and top and bottom views for all RCA Victor television receivers manufactured in 1950 and 1951 (71 models). Comprehensive index, easy-to-read model numbers, and grouping of information on each set provide a ready source of reference for the service technician. Price \$1.50.\*
- **SERVICE PARTS DIRECTORY FOR RCA VICTOR TV RECEIVERS—SP-1021** (10 $\frac{7}{8}$ " x 16 $\frac{3}{4}$ ") 36 pages. Schematic diagrams, wiring diagrams, replacement parts lists, and top and bottom views for all RCA Victor television receivers manufactured in 1952 (27 models). Comprehensive index includes cross reference of model names to model numbers and references to proper publications for information on RCA models made prior to 1952. Price 50 cents.\*
- **SERVICE PARTS DIRECTORY FOR RCA VICTOR RADIOS—SP-1008** (10 $\frac{7}{8}$ " x 8 $\frac{3}{8}$ ")—24 pages. Lists stock numbers of major replacement parts by receiver model numbers for over 600 RCA Victor radio receivers. Covers period from 1938 through 1950. Price 15 cents.\*
- **RCA TV COMPONENTS—CTV-1015** (10 $\frac{7}{8}$ " x 8 $\frac{3}{8}$ ") 24 pages. Presents electrical characteristics and ratings of 88 RCA TV components in an easy-to-use form. Contains dimensional outlines, chassis cutout dimensions, and five pages of typical circuits. Many of the tables contain information on associated TV components. kinescopes, and camera tubes. To provide for quick reference, components are indexed in numerical order by type designation, and in alphabetical order by their function. Price 35 cents.\*
- **RCA COMPONENTS DIRECTORY FOR TV RECEIVERS—SP-1006B** (10 $\frac{7}{8}$ " x 8 $\frac{3}{8}$ ") 20 pages. Lists major components of more than 70 brands of TV receivers for which RCA replacement components are available. Prepared especially for service technicians and parts distributors. Easy-to-use format simplifies location of proper replacement part. Price 25 cents.\*
- **TV SERVICING**. Bulletin TVS-1030 (10 $\frac{7}{8}$ " x 8 $\frac{3}{8}$ ")—48 pages. This new booklet contains a compilation of articles on TV trouble shooting, TV tuner alignment, and TV circuit analysis by two of RCA's experts in the field of TV servicing and test equipment—John R. Meagher and Art Liebscher. Price 35 cents.\*
- **TV SERVICING, SUPPLEMENT 1**. Bulletin TVS-1031 (10 $\frac{7}{8}$ " x 8 $\frac{3}{8}$ ")—12 pages. This new booklet contains an article by John R. Meagher on solving trouble shooting problems in those hard-to-service television receivers known to service technicians as "tough" sets or "dogs." Emphasizes time-saving component-checking techniques and proper use of test equipment. Price 15 cents.\*
- **RCA VICTOR TV SERVICE PARTS GUIDE—SP-2001** (10 $\frac{7}{8}$ " x 8 $\frac{3}{8}$ ") 12 pages. Lists stock numbers of major replacement parts for RCA Victor TV sets by receiver-model number. Covers period from 1946 through 1953. Price 25 cents.\*
- **RCA VICTOR TUNER PARTS GUIDE—SP-2002** (10 $\frac{7}{8}$ " x 8 $\frac{3}{8}$ ") Single sheet. Lists stock numbers of tuner-replacement parts by tuner-chassis numbers. Also lists tuner-chassis numbers by RCA Victor model numbers. Covers period of 1946 through 1953. Single copy free on request.
- **RCA PHONOGRAPH CARTRIDGE GUIDE—SP-2003** (10 $\frac{7}{8}$ " x 8 $\frac{3}{8}$ ") Single sheet. Lists stock numbers of RCA cartridges and replacement styli. Also lists stock numbers of RCA cartridges and model numbers of record players by RCA Victor model numbers. Single copy free on request.



## Test and Measuring Equipment

● **INSTRUCTION BOOKLETS**—Complete instruction booklets, containing specifications, maintenance and operating data, replacement parts lists, and schematic diagrams, are available for all RCA test equipment. Instruction booklets for the following popular instruments are available at the prices indicated.

25 cents each

WO-55A (3" Oscilloscope)  
WO-58A (5" Oscilloscope)  
WR-39A (TV Calibrator)  
WR-59A (TV Sweep Generator)  
WR-67A (Test Oscillator)  
WV-65A (VoltOhmyst†)  
WV-75A (VoltOhmyst†)  
WV-77A (VoltOhmyst†)  
WV-84A (Microammeter)  
WV-95A (VoltOhmyst†)  
165 (VoltOhmyst†)  
165-A (VoltOhmyst†)  
195-A (VoltOhmyst†)

50 cents each

WA-44A (Audio Oscillator)  
WO-56A (7" Oscilloscope)  
WO-57A (3" Oscilloscope)  
WO-57B (3" Oscilloscope)  
WO-60C (5" Oscilloscope)  
WO-78A (5" Oscilloscope)  
WO-79A (3" Oscilloscope)  
WO-79B (3" Oscilloscope)  
WO-88A (5" Oscilloscope)  
WR-36A (Dot-Bar Generator)  
WR-39B (TV Calibrator)  
WR-39C (TV Calibrator)  
WR-40A (UHF Generator)  
WR-41A (UHF Generator)  
WR-41B (UHF Generator)  
WR-49A (RF Generator)  
WR-59B (TV Sweep Generator)  
WR-59C (TV Sweep Generator)  
WR-61A (Color-Bar Generator)  
WR-86A (UHF Sweep Generator)  
WR-89A (Marker Generator)  
WV-37A (Battery Tester)  
WV-87A (VoltOhmyst†)  
WV-97A (VoltOhmyst†)

Prices for Booklets on other RCA test instruments are available on request.

## Batteries

● **RCA RADIO BATTERIES FOR FLASHLIGHT, RADIO, AND INDUSTRIAL APPLICATIONS**—BAT-134B (10 $\frac{7}{8}$ " x 8 $\frac{3}{8}$ ")—8 pages. Contains characteristics, terminal connections, and socket patterns of 82 RCA dry batteries for radio, flashlight, and industrial applications. Includes interchangeability directory, and a battery replacement guide for 1948 to 1954 inclusive for portable radios. Single copy free on request.

†Trade Mark Reg. U. S. Pat. Off.

# Reading List

This list includes references of both elementary and advanced character. Obviously, the list is not inclusive, but it will guide the reader to other references.

- ALBERT, A. L. *Fundamental Electronics and Vacuum Tubes*. The MacMillan Co.
- CHAFFEE, E. L. *Theory of Thermionic Vacuum Tubes*. McGraw-Hill Book Co., Inc.
- CHUTE, G. M. *Electronics in Industry*. McGraw-Hill Book Co., Inc.
- DOME, R. B. *Television Principles*. McGraw-Hill Book Co., Inc.
- DOW, W. G. *Fundamentals of Engineering Electronics*. John Wiley and Sons, Inc.
- EASTMAN, A. V. *Fundamentals of Vacuum Tubes*. McGraw-Hill Book Co., Inc.
- EVERITT, W. L. *Communication Engineering*. McGraw-Hill Book Co., Inc.
- FINK, D. G. *Engineering Electronics*. McGraw-Hill Book Co., Inc.
- FINK, D. G. *Television Engineering*. McGraw-Hill Book Co., Inc.
- GHIRARDI, A. A. *Radio and Television Receiver Circuitry and Operation*. Rinehart and Co., Inc.
- GRAY, T. S. *Applied Electronics*. John Wiley and Sons, Inc.
- GROB, B. *Basic Television*. McGraw-Hill Book Co., Inc.
- HENNEY, KEITH *Radio Engineering Handbook* McGraw-Hill Book Co., Inc.
- HOAG, J. B. *Basic Radio*. D. Van Nostrand Co., Inc.
- KOLLER, L. R. *Physics of Electron Tubes*. McGraw-Hill Book Co., Inc.
- MAEDEL, G. F. *Basic Mathematics for Television and Radio*. Prentice-Hall, Inc.
- MARCUS, A. *Elements of Radio*. Prentice-Hall, Inc.
- MARKUS AND ZELUFF. *Handbook of Industrial Electronic Circuits*. McGraw-Hill Book Co., Inc.
- MOYER AND WOSTREL. *Radio Receiving and Television Tubes*. McGraw-Hill Book Co., Inc.
- PENDER, DELMAR, AND MCILWAIN. *Handbook for Electrical Engineers—Communications and Electronics*. John Wiley and Sons, Inc.
- PREISMAN, A. *Graphical Constructions for Vacuum Tube Circuits*. McGraw-Hill Book Co., Inc.
- Proceedings of the Institute of Radio Engineers* (a monthly publication).
- RCA TECHNICAL BOOK SERIES. *Electron Tubes, Vol. I and Vol. II*. RCA Review.
- REICH, H. J. *Theory and Applications of Electron Tubes*. McGraw-Hill Book Co., Inc.
- RICHTER, WALTHER. *Fundamentals of Industrial Electronic Circuits*. McGraw-Hill Book Co., Inc.
- SPANGENBERG, K. R. *Vacuum Tubes*. McGraw-Hill Book Co., Inc.
- TERMAN, F. E. *Fundamentals of Radio*. McGraw-Hill Book Co., Inc.
- TERMAN, F. E. *Radio Engineers Handbook*. McGraw-Hill Book Co., Inc.
- The Radio Amateurs Handbook*. American Radio Relay League.
- VAN DER BIJL, H. J. *Thermionic Vacuum Tubes*. McGraw-Hill Book Co., Inc.
- ZWORYKIN AND MORTON. *Television: The Electronics of Image Transmission*. John Wiley and Sons, Inc.

## RCA Receiving Types NOT Recommended For New Equipment Design

Certain receiving tube types should be avoided in the design of new equipment because they are approaching obsolescence or have limited or dwindling demand. Such RCA Types are listed below:

|          |        |          |          |             |
|----------|--------|----------|----------|-------------|
| 1A5-GT   | 6AR5   | 6S7      | 12SK7-GT | 35A5        |
| 1C5-GT   | 6B4-G  | 6S8-GT   | 14B8     | 35Y4        |
| 1D8-GT   | 6B8    | 6SA7-GT  | 14C5     | 35Z3        |
| 1G6-GT   | 6BF5   | 6SB7-Y   | 14CP4    | 35Z4-GT     |
| 1Q5-GT   | 6C5-GT | 6SF5-GT  | 14H7     | 41          |
| 1S4      | 6C6    | 6SF7     | 16DP4-A  | 42          |
| 1-V      | 6C8-G  | 6SJ7-GT  | 16GP4    | 43          |
| 3KP4     | 6D6    | 6SK7-GT  | 16KP4    | 45          |
| 5AZ4     | 6F5    | 6SQ7-GT  | 16LP4-A  | 47          |
| 5T4      | 6F5-GT | 6SS7     | 16RP4    | 50A5        |
| 5W4-GT   | 6F6-G  | 6ST7     | 16TP4    | 50C6-G      |
| 5X4-G    | 5F7    | 6SZ7     | 16WP4-A  | 50X6        |
| 5Y3-G    | 6F8-G  | 6U5      | 19AP4-A  | 50Y7-GT     |
| 5Y4-G    | 6G6-G  | 6X5      | 19BG6-G  | 70L7-GT     |
| 5Z3      | 6H6-GT | 7E7      | 19J6     | 71-A        |
| 6A7      | 6J7-GT | 10FP4-A  | 19T8     | 75          |
| 6A8      | 6J8-G  | 12A8-GT  | 19X8     | 77          |
| 6A8-G    | 6K7    | 12AH7-GT | 24-A     | 78          |
| 6A8-GT   | 6K7-G  | 12AW6    | 25A6     | 83-V        |
| 6AB5/6N5 | 6K7-GT | 12J5-GT  | 25W4-GT  | 84/6Z4      |
| 6AB7     | 6N7    | 12J7-GT  | 25Z5     | 117L7/M7-GT |
| 6AC5-GT  | 6Q7    | 12K7-GT  | 25Z6     | 117N7-GT    |
| 6AD7-G   | 6Q7-GT | 12KP4-A  | 25Z6-GT  | 117P7-GT    |
| 6AQ7-GT  | 6R7    | 12Q7-GT  | 27       | 117Z6-GT    |

---

### RCA Preferred Types List

A list of preferred tube types is available to assist equipment designers and manufacturers in formulating their plans for future production of electronic equipment. This list is based on periodic surveys of the needs of the engineering and manufacturing fields and keeps abreast of technological advances in tube design and application.

A copy of the current list will be gladly furnished on request. Write to Commercial Engineering, Tube Division, Radio Corporation of America, Harrison, N. J.

